



HIGH EFFICIENT AND RELIABLE ARRANGEMENTS FOR CROSSMODAL TRANSPORT

Project start Date: 01 January 2010 – **Project Duration:** 24 months

Contract Number: TCP8-GA-2009-234082

Collaborative project small of medium-scale focused
research project

Priority: Horizontal Activities For Implementation of the
Transport Programme (TPT.2008.13)



DELIVERABLE 5

CASE STUDIES

Partner Responsible: TFK, IST

Date: 10th March 2012

This page is intentionally blank

Document Id:	HERMES_D5_WP5.docx
Document Title:	Deliverable 5 Case Studies
Version of the Document:	Final Version 2
Dissemination Level:	Public
Work Package Allocation:	WP5
Due date of delivery:	10th March 2012
Authors	Monica Lundin (TFK), Rosário Macário (IST), Vasco Reis (IST)
Authors for different case studies:	
Gothenburg Central, Arlanda Airport	TFK Team: Amra Halilovic, Monica Lundin, Marie Magnusson
Avenida de América, Zaragoza-Lleida	UPM Transyt Team: Andrea Alonso, Giulia Dell' Asin, Luis Ángel Guzmán María Eugenia López-Lambas, Andrés Monzón Cristina Valdés
Gare de Oriente, Faro International Airport	IST Team: Prof. Rosário Macário, Prof. José Viegas Álvaro Barreira, João Fonseca, Liliana Magalhães, Vasco Reis, Luis Martinez
Intermodal Network of Lyon Metropolitan Area	CNRS-LET Team: Aurélie Mercier, Florent Laroche, Yves Crozet
Antwerp Airport	UA-TPR Team: Els Kusseneers, Thierry Vanelslander
Frankfurt-Hahn Airport	KIT Team: Thomas Fluhrer, Eckhard Szimba, Aaron Scholz
Extension of the Adriatic - Ionian corridor – from Peloponnese to Crete	Aegean Team: Seraphim Kapros, Argyro Kostaki, Costas Panou, Amalia Polydoropoulou, Athena Roumboutsos, Athena Tsirimpa
Port of Patras	CERTH Team: Anestis Papanikolaou, Maria Morfoulaki

Document History		
#	Date	Version
1	1-12-2011	Final draft
2	2-12-2011	Final Version
3	20-02-2012	Draft
4	10-03-2012	Final Version 2

This page is intentionally blank

Table of Contents

1	INTRODUCTION	7
1.1	WP5 objectives	7
1.2	Case Studies in WP5	8
1.3	Framework for evaluation	9
2	CASE STUDIES OVERVIEW	11
2.1	Gothenburg Central Station, Sweden	11
2.2	Avenida de América Interchange Madrid, Spain	12
2.3	Long distance bus services connected with high speed rail services, the case of Lerida and Zaragoza, Spain	14
2.4	Gare de Oriente Interchange, Portugal	16
2.5	Intermodal Network of Lyon Metropolitan Area, Part Dieu Station, France	18
2.6	Faro International Airport, Portugal	21
2.7	Antwerp Airport, Belgium	23
2.8	Frankfurt-Hahn Regional Airport, Germany	24
2.9	Stockholm Arlanda International Airport, Sweden	26
2.10	Extension of the Adriatic – Ionian corridor – from Peloponnese to Crete Greece	28
2.11	Port of Patras, Greece	31
3	Validation of Prototypes	34
3.1	Introduction	34
3.2	Induction of the prototypes of business models	37
3.3	Deduction of the case studies’ business models for improved intermodality	38
3.4	Evidences of improvement for the validation of the prototypes of business models	39
3.5	Conclusions	40
4	CROSS-FINDINGS OF THE CASE STUDIES	41
4.1	Framework of Analysis of Business Model	42
4.2	Cross-findings of the analysis to the current business model	43
4.3	Cross-findings of the analysis to the proposed business model	52
4.4	Conclusions	59
5	REFERENCES	73
5.1	Literature	73
5.2	Websites	75
6	Annexes - Detailed Description of the Case Studies	77
6.1	Gothenburg Central Station, Sweden	77
6.2	Avenida de América Interchange Madrid, Spain	122

6.3	Zaragoza – Lleida, Spain	174
6.4	Gare de Oriente, Portugal	247
6.5	Intermodal Network of Lyon Metropolitan Area, Part Dieu Station, France	268
6.6	Faro International Airport, Portugal	319
6.7	Antwerp Airport, Belgium	360
6.8	Frankfurt-Hahn Regional Airport, Germany	458
6.9	Stockholm Arlanda International Airport, Sweden	508
6.10	Extension of the Adriatic – Ionian corridor – from Peloponnese to Crete Greece	561
6.11	Port of Patras, Greece	607

1 INTRODUCTION

The HERMES project, as a whole, will analyze the existing connections and will further evaluate the level of interconnectivity in the passenger terminals where short and long-distance transport networks cross and where fluidity between crossing networks should ensure the maintenance of the level of service when passengers are transferred from one to the other.

Prototypes of suitable business models for intermodal or interconnecting services that will contribute to build sustainable mobility solutions will be developed. According to Osterwalder (2004) a business model describes the rationale of how an organization creates, delivers, and captures value and as such consists of nine different building blocks, which will be further described below.

Within a business model there could be certain factors that act as “missing links”, which could obstruct the business model from functioning optimally. These missing links can be for example the offering, strategies, infrastructure, organizational structures, trading practices or operational processes and policies. Throughout these and besides the HERMES main objectives, there are some expectations from WP5 ‘Case studies’.

1.1 WP5 objectives

WP5 has the following expectations: to describe the current business models at the site, to describe the current level of quality of services and identify good practices and missing links at the sites.

According to these expectations, WP5’s objectives in more detail are:

- 1) To validate the prototypes developed in WP2 through an evaluation methodology that will be applied to 11 case studies
- 2) To validate interconnectivity barriers and measures (developed in WP3 and WP4)
- 3) To gain more information about interconnectivity barriers and measures (developed in WP3 and WP4)

To be able to validate and gain more information about interconnectivity barriers and measures there is a need of different WP perspectives; mainly WP2, WP3 and WP4 (see Figure 1). As the Figure 1 shows, WP5’s objective is to complement the previous studies with a case study perspective.

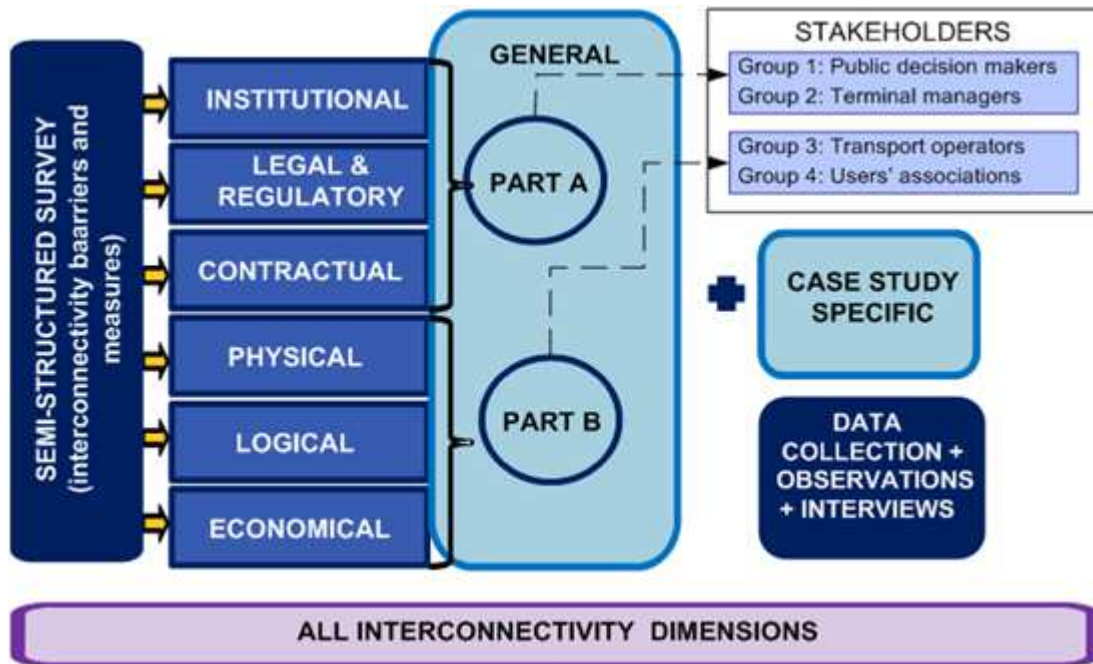


Figure 1.1: WP5 in correlation with WP3 and WP4

The results from the case studies will then be compiled as a basis for the conclusions and recommendations on good practices that will be performed in WP6. The consolidated results of this work package can be generalized in a meaningful way to political, organizational and technical recommendations for the local/regional/national authorities, transport operators and infrastructure managers.

1.2 Case Studies in WP5

Examples of different business models of the innovative services have been developed and further tested in different case studies for validation of its functional, economic and organizational aspects. At a later stage recommendations will be provided regarding enhanced co-ordination between decision-making levels on issues related to the interconnection of transport networks of different scales and modes, addressing institutional, legal, design, planning, technical and deployment aspects.

WP 5 aims more specifically to validate the prototypes developed in WP2 through an evaluation methodology that has been applied to 11 case studies. The prototypes of business models are examples that represent core aspects of business, including purpose, offering, strategies, infrastructure, organizational structures, trading practices and operational processes and policies. The case studies will cover a wide diversity of realities instead of being concerned with a balance of the sample.

The case studies have also been used for gaining information and advice on regulatory and legal requirements for interconnectivity (WP3) and barriers to interconnectivity (WP4) and thus provide a second opinion and validation of the results from these preceding work packages. This is to strengthen our conclusions and recommendations on identified good practices and further propose a set of actions to be taken aiming the future improvement of the current level of interconnectivity. Furthermore WP5 has gathered additional data and information for the validation through its case-study approach.

11 case studies have been chosen in order to cover a wide diversity of situations of interconnectivity and will illustrate the possible variants to the identified missing links. These case studies have been divided into the following groups:

Station cases:

- Gothenburg Central Station, road/rail
- Avenida de America Interchange Madrid, road/rail
- Lerida-Zaragoza, road/rail
- Gare de Oriente Interchange Lisbon, road/rail
- Intermodal Network of Lyon Metropolitan Area, road/rail

Airport cases:

- Faro International Airport, air/road
- Antwerp Airport, air/road
- Frankfurt-Hahn Regional Airport, air/road/(rail)
- Stockholm Arlanda International Airport, air/road/rail

Maritime cases:

- Peloponnese-Crete, road/ferry
- Port of Patras, road/rail/ferry

1.3 Framework for evaluation

The case studies and their analysis have been supported by a harmonized assessment framework where guidelines and reporting templates have been developed to ensure an adequate analysis of cross-findings.

In the initial stage of the project a Case and Validation Plan has been written for each case. Here each case was described in general terms together with the planned performance of the case study and its validation to ensure a fundamental comparability between the eleven different case studies performed within WP5 of the HERMES-project.

A purpose for the Case and Validation Plan was also to be used as a validation tool by all site managers/teams in order to make sure that each site in a harmonized way would

collect, provide and monitor data/information needed for WP5 validation of results from proceeding work packages, as well as for providing the foundation for WP6 synthesis and best practice examples.

It should be stressed that the planning and the overall responsibility lies on the site manager/team, who guarantees that the validation plan is reliable and meets the specific needs at each specific site/case.

In order to achieve a high quality outcome – in terms of a high comparability of the case studies' results across all countries as well as for the facilitation of the evaluation process – guidelines for the conduction of the HERMES case studies were produced together with a template for a passenger questionnaire.

The results have been summarized in case study reports, one for each case study. A template for the case study report has been produced. These 11 Case Study Reports has then be compiled to this Deliverable D5 'Case Studies'.

The organization of this deliverable is as follows. The next Chapter presents an overview of the eleven case studies (the full description can be found in the Annexes). The following chapter presents the cross-findings of the various case studies and, consequently, present the validation of the prototypes developed in WP2. The last Chapter concludes this Deliverable with a brief summary of the main findings.

2 CASE STUDIES OVERVIEW

2.1 Gothenburg Central Station, Sweden

2.1.1 Brief characterisation of the Case Study

Gothenburg Central Station is the major national, as well as the regional, transport hub for passenger transportation in the south west of Sweden. The station is an interchange of great importance with about 100 000 passengers per weekday, furthermore the travelling to and from the Central Station is increasing continuously. The following public transport services are offered at Gothenburg Central: 13 lines for long-distance rail services, 6 lines for short-distance rail services, 13 lines for long-distance bus services and 25 lines for short-distance bus services.

The case study of Gothenburg Central Station covers all three levels of interconnectivity which are addressed in the HERMES project:

- Interfaces between different modes: rail – road
- Interfaces between different type of service of the same mode: rail-rail, road-road
- Interfaces between high capacity and low capacity mode: bus and taxi etc.

2.1.2 Current Level of Quality and Missing Links

According to the customer survey and interviews with the stakeholders the current level of quality at Gothenburg Central Station is very high. Customer's satisfaction is very high with coordinated timetables, possibilities to combine transport modes and walking distance to transfer services. Customers are overall satisfied with facilities at the site. It should be noted that the customer survey was not carried out during winter times. According to the customer survey several possible improvements can be highlighted. When it comes to Facilities, the customers would like to see improvements regarding total seating capacity, toilet capacity and toilet cleaning, better access to the WiFi/Internet and improved security on the site. The missing link that has been identified at the station concerns information. The customers demand better integrated ticket systems, integrated departure/transfer information, integrated time-tables for different transport operators and accurate information why there are delays and by how much, especially during winter season. It will be crucial to have well-functioned information services in the future as Sweden also will deregulate all passenger transport from January 1st 2012. This implies that there will be more transport operators at the station and the passenger needs co-ordinated information.

2.1.3 Changes for improved Interconnectivity

The main concept of our proposal is to: “Integrate traffic information on various transport services provided by different transport operators and make this information available to customers”. This can be achieved by introducing a new agent at Gothenburg Central Station. This/these new agents are here called “Traffic Information Brokers” and their task should be to create a new and innovative way to integrate and distribute traffic information. They can also have traffic information centres at the Site. The most critical service level for this information is information reliability.

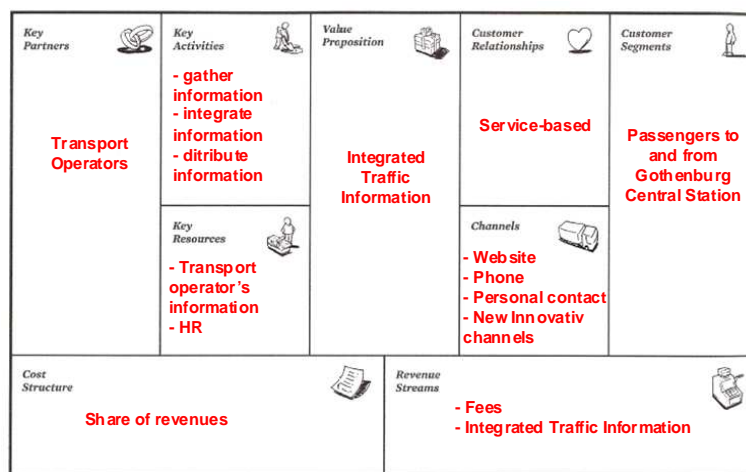


Figure 2.1 - Business Model - Integrated Traffic Information

2.2 Avenida de América Interchange Madrid, Spain

2.2.1 Brief characterisation of the Case Study

Avenida de América is an interchange located in the city of Madrid, in the interface between the A-II motorway and the M-30 orbital road, collecting the flows from the so called Henares corridor and the North-East of Spain. This is a dense part in the NE of the city, only 1.6 km from Paseo de la Castellana, the central artery of the Madrid CBD.

Avenida de America is made up of four underground floors on a rectangular layout (208 x 49 meters). The structure is about 16 meters depth. Level “-1” is dedicated to long-distance buses and has 18 platforms; level “-2” was designed for urban and regional buses and has 19 platforms; levels “-3” and “-4” are dedicated to the underground network connection (Metro) and the rotation (253 places) and residents (392 places) car parking. Commercial areas, together with ticket offices, are located at levels “-1” and “-3”. Although the interchange shows a vertical design, good accessibility is provided.

2.2.2 Current Level of Quality and Missing Links

The specific problems of the cases study can be classified into three groups:

Bad information or signalling:

- According to the surveys this issue should be improved. (30 % of the respondents)

Lack of physical integration:

- Insufficient number of quays (which does not allow operators to offer more destinations).
- Bad organization of the motorized mobility around the interchange. There is no place for cars to drop travelers (kiss and ride).

Non adequate relationships between agents:

- There is a lack of coordination among the different stakeholders, particularly between Transport Operators, which results in a lack of coordination among short and long distance modes
- Decision Makers are not well aware of the specific problems of the Interchange, and the Terminal manager -who is very close to the users' opinions and complaints-, cannot make decisions.

2.2.3 Changes for improved Interconnectivity

In this paragraph feasible actions to overcome the above mentioned barriers are described:

Information and signalling

There should be **integrated information systems for all modes**, regardless long or short distance.

Physical Integration

- We propose an **extension of the geographical coverage**: if operators should increase the **long distance supply** more passengers should use the Interchange.
- There should be **Joint parking management according to the interchange needs (space for bus parking or drop off parking)**.

Relationships between agents

We propose the following relationships between stakeholders: a **Terminal manager** acting **independently from Transport Operators, Decision Makers delegating** some decisions to the **Terminal Manager** (those affecting transfers into the interchange or station). In addition, not only **Transport Operators** should be **responsible for the service provided to users**, but **also the Terminal Manager**, since users highly value the whole journey where the transfer is very relevant; and all of them should work **coordinated**.

A better management of the existing resources will benefit all agents.

2.3 Long distance bus services connected with high speed rail services, the case of Lerida and Zaragoza, Spain

2.3.1 Brief characterisation of the Case Study

Zaragoza and Lleida are two Spanish cities located in the North, 150 km distance one from the other but very well connected, especially by High Speed Railway connections. With this Case Study Lleida Train Station and Zaragoza Train-Bus Station have been analysed in parallel, to find out similarities in their business models and key barriers.

Zaragoza

The building of the Zaragoza Interchange (opened in 2003) covers an area of 190.000 m2. It consists of 8 rail platforms about 400 meters long, for high-speed and conventional rail passenger service lines. As regards parking facilities, there are two external areas with 1800 places available as well as underground parking lots. To improve intermodality with soft modes a bicycle storage outside the interchange is provided. Inside the station a travel agency, one hotel, a Police Station, and several waiting areas, restaurants, shops and car rental services are located.

The central bus station is physically integrated in the building, but only interurban and long distance bus services are available. There are 46 bus platforms.

Lleida

Lleida railway station underwent an important refurbishment and expansion to fit high speed requirements (1999-2001).

However, only urban bus services and taxis are provided. Some regional buses at the station provide a second stop near the train station. In addition, a new bus station will be constructed next to the railway station, together with other 600 parking places.

<p>Zaragoza Services:</p> <ul style="list-style-type: none"> -High Speed Rail Services -Long Distance Rail Service -11 long Distance Bus Services -Regional rail services -4 Urban Bus lines -Taxi Services 		<p>Lleida Services:</p> <ul style="list-style-type: none"> -High Speed Rail Services -Long Distance Rail -Regional Rail Services -4 Urban Bus line (not integrated) -Taxi Services
---	--	---

Figure 2.2 – Zaragoza and Lleida Station

2.3.2 Current Level of Quality and Missing Links

The specific problems of the cases study can be classified into three groups:

Bad information and signalling:

No integrated information provided for all existing modes at the Stations, but separated information systems for bus and train services.

Physical Integration:

At **Zaragoza Station** there is a physical barrier (a fence) between the railway and the bus station; therefore despite the fact that both stations are adjacent, passengers have to walk a long distance to get one or another; which affects intermodality between long distance bus and train very negatively. In addition, there are parking places at the train station side, and as a consequence of this physical barrier the street facing the bus station side is permanently congested, with cars illegally parked to the detriment of local buses and taxi services performance.

At **Lleida Station**, despite the fact that most passengers arrive by car, there is no parking at the station. However, a 600 car places parking will be constructed in the near future.

Relationships between agents:

- Both the Terminal Manager and the Decision makers are appointed by Adif, the owner of the railway infrastructure, both too focused into railway services, not in intermodality; which results in a lack of collaboration.
- Local Transport Authorities are not involved nor in the management of the station neither in the decision making process.
- There is no collaboration between bus and train Operators.

2.3.3 Changes for improved Interconnectivity

In this paragraph feasible actions to overcome the above mentioned barriers are described:

Information and signalling:

Integrated information systems for all modes should be provided, regardless long or short distance.

Physical integration:

- At **Zaragoza Station**, **accessibility** between **bus and train** stations should be **improved**
- At **Lleida Station**, the lack of car places and the high number of passengers arriving by car make the **construction of new parking lots** a top priority **Frequencies and services of local buses stopping in front of the station** should be improved as well.

Relationships between stakeholders:

Local Transport Authorities should be more involved in Terminal Manager and Decision Makers (both appointed by Adif) **activities**. All **stakeholders** should collaborate and coordinate their activities in order **to foster transfers**.

2.4 Gare de Oriente Interchange, Portugal

2.4.1 Brief characterisation of the Case Study

This case study refers to the connections from the Portuguese north rail-line (Linha do Norte) to small cities nearby, in the Greater Lisbon area. Nowadays, connections to these small cities are provided by bus from Lisbon (Gare do Oriente) although rail stations in north rail-line could represent a closer starting point for these cities. It was our belief that there could be enough passengers whose final destination is a city geographically near from a rail station in the north rail-line that could justify the creation of new transport connections from those railway stations, instead of having to travel (southward) by rail till Lisbon and take the bus there (northward) to those small cities. Our motivation was to check whether it would be possible to provide better transport service to those rail passengers in the final link to their destinations, without affecting the railway service on a negative way.

Linha do Norte (North rail-line in English) is the main railway line in Portugal. This line connects the two main Portuguese cities: Lisbon and Oporto. The most emblematic and important railway station in the north rail-line is Gare do Oriente Intermodal Terminal, in Lisbon. This terminal is located some 10 km away from the city center. It gathers subway, short and long distance rail, taxis and local, suburban and long-distance bus transport services. There are also rent-a-car services at the site and an underground parking lot.

Another relevant station in the north rail-line is Vila Franca de Xira. In this station circulates inter-urban, inter-cities and regional trains. Vila Franca de Xira station is 20 km away from Gare do Oriente. In the cities surrounding the Vila de Franca de Xira there is a significant population concentration within a 10 km radius from the station (92,656 inhabitants). This population concentration might justify the creation of dedicated feeder services from these locations to the Vila Franca de Xira station.

Linha do Norte stakeholders are:

- CP – responsible for the railway operations;
- REFER – responsible for the railway infrastructure management.

Vila Franca de Xira train station stakeholders are:

- **Public Decision Makers:** REFER (owner of the railway stations) and the municipality of Vila Franca de Xira;
- **Transport Operators:** short distance bus operator (BoaViagem) and taxis;

- **Consumers' Association:** DECO.

2.4.2 Current Level of Quality and Missing Links

The main problems identified along the north rail line are:

- Poor connections to small-sized cities from train stations in the greater Lisbon area (most connections are only provided from Gare do Oriente);
- Poor or inexistent information about further connections (besides train) or adjustments of connections;
- Poor information signaling in the stations;

We had also identified the opportunities at the site:

- Good road connections from other train stations besides Gare do Oriente to small-sized cities;
- Space for information desks at train stations or information displays;
- Good access for people with special mobility needs.

Current value proposition is characterized by good railway service in the Linha do Norte rail link, with good integration to bus services from Lisbon Oriente to small-cities . Passengers with destinations in the greater Lisbon area always have to use Lisbon as an origin point despite other rail stations being geographically closer to serve these small-cities. Vila Franca de Xira, for instance is closer to Coruche than Lisbon but there are no bus connections nowadays from there. Other example is Santarém which is closer to Peniche than Lisbon but once again there are no bus connections to Peniche except from Lisbon. Vila Franca de Xira is the city that we choose to analyse.

Our expectation is that there could be an interesting number of passengers whose final destination is a city geographically near from a rail station in the north rail-line that have to departure from Lisbon since there are no transport connections from the other rail stations. This is the case of Vila Franca de Xira rail station, which is closer to some of those small-cities than the Oriente station in Lisbon, but does not offer adequate bus transport connections.

Our intention is to provide better transport service to rail passengers without affecting the quality of the rail services.

2.4.3 Changes for improved Interconnectivity

The analysis of the survey results clearly shows that our initial hypothesis was not confirmed, thus leading to the conclusion that it does not make sense to develop new direct bus services from Vila Franca de Xira rail station to small-cities nearby. With such a small market potential the new transport service is not feasible.

The analysis of the measured demand patterns shows that the market to feed railway service is already balanced, and passengers are already well served in terms of public transport accessibility by the large amount of urban and suburban services available at the Gare do Oriente station.

Since the initial hypothesis was not confirmed, no new services are needed and no change in the prevailing business models is necessary. As it was mentioned above, transport market regulated and balanced, so, passengers that need to travel to the small-city are using other transport (i.e. private car) and not train plus other mode.

In theory, because surveys were only done at the railway station, it is possible that there are several potential customers for those bus services feeding the intermediate railway stations that currently use another transport mode for their long distance trip, for example, private car. We believe this is not the case, because in any case the travel time by car or bus from those small cities to the Oriente station is rather short (always below 30 minutes) and so the advantages of using the rail for the long distance trip are already within reach.

2.5 Intermodal Network of Lyon Metropolitan Area, Part Dieu Station, France

2.5.1 Brief characterisation of the Case Study

The Part-Dieu station is today one of the most important station in Europe for transit passenger traffic. It proposes and connects different transport modes (rail, bus, car and two-wheel modes) at long and short distances. The station has been planned in 1983 for a daily traffic of 35.000 passengers. In 2001 its traffic hit 80.000 daily users. The number of persons using the Part-Dieu station at the end of 2008 is estimated to 135.000 per day (22,8 million per year) with among them 105.000 rail passengers (see RFF, 2011). More than one user in five crossing or spending time on the Part-Dieu station is not a rail passenger.

Three main categories of agents have been identified in the Part-Dieu case study: the terminal manager, public decision makers, users (with users' associations). Transport operators, also using the Part-Dieu station are not really involved in the inter-modal transfer issue.

To achieve transfer time minimization and in-station passenger flow improvement, terminal managers can implement passenger traffic lanes. These traffic lanes should be clearly delimited with stopping areas. Visual signs and/or personnel should be used to inform the Part-Dieu station user.

Part-Dieu station user could adopt a new strategy changing departure and/or arrival time in the Part-Dieu station for non-constrained trips. First, they don't suffer any more from passenger traffic congestion and then, they limit congestion in peak-hour. Another strategy, more radical than previously, consists in changing the departure/arrival station. Indeed, most of short and long distance trains serve both the Part-Dieu station and the Perrache station. The last station is not congested and is also linked to metro, tram and bus network.

2.5.2 Current Level of Quality and Missing Links

The Part-Dieu station has been planned in 1983 for a daily traffic of 35.000 passengers. In 2001 its traffic hit 80.000 daily users. In this context, the crucial point for the Part-Dieu station managers is to improve passenger quality of services and more precisely the following items:

- Passengers information (on delays, train track...);
- Signage improvement;
- Modal and intermodal transfer time improvement;
- Facilities development : shops and other services;
- Safety, comfort improvement in waiting areas;
- Cleaning and hygiene.

According to forecasts, the number of daily passengers should increase to 130,000 in 2013 and 156, 000 in 2020. Such an increase can be explained first by a higher demand for short rail trips from or to Lyon, mainly for home to work trips. Between 2004 and 2009, short rail trip demand has increased by 7% per year and the tendency should continue (an increase hypothesis of 4.8% until 2030 is announced by RFF). The second main factor explaining an increase of the Part-Dieu station daily passengers is the long distance rail network improvement.

To prevent from a saturation increase and to renovate the station, a multi-phased improvement program is planned with a new platform access and signage improvement scheme and a new passenger rail track (in 2010), a central walking lane widening and an east entrance improvement, a new track development, a plan to improve intermodality on the station neighbourhoods (in 2013).

Missing links can be summarized within the 6 following items:

- Real-time information system to passengers/transport operators and terminal manager on the station
- Timetable synchronization for interconnected modes
- Signage improvement to access to facilities (other than shops) and linked sound signposting
- Passengers corridors inside the station to regulate traffic flow
- Accessibility facilities – mainly for disabled persons
- Waiting time areas with seats and facilities to occupy waiting time

2.5.3 Changes for improved Interconnectivity

The proposal developed in this sub- section aims to overcome the current barriers using a three-type improvement scheme. In a first time, improvement need is “physical”. It doesn't need to high financial resources and refers first to passengers corridors implementation coupled to signage improvement and then to a waiting time areas capacities increase.

The second improvement is technological and/or technical. It is composed central by a real-time information system for passengers, transport operators and terminal manager. Its aims also to reduce differences on accessibility to facilities between disabled and non-disabled persons, with adapted equipment. Technical improvements need high financial resources.

The third improvement refers to transport system organization with a timetable for interconnected modes, mainly for short and long distances rail modes.

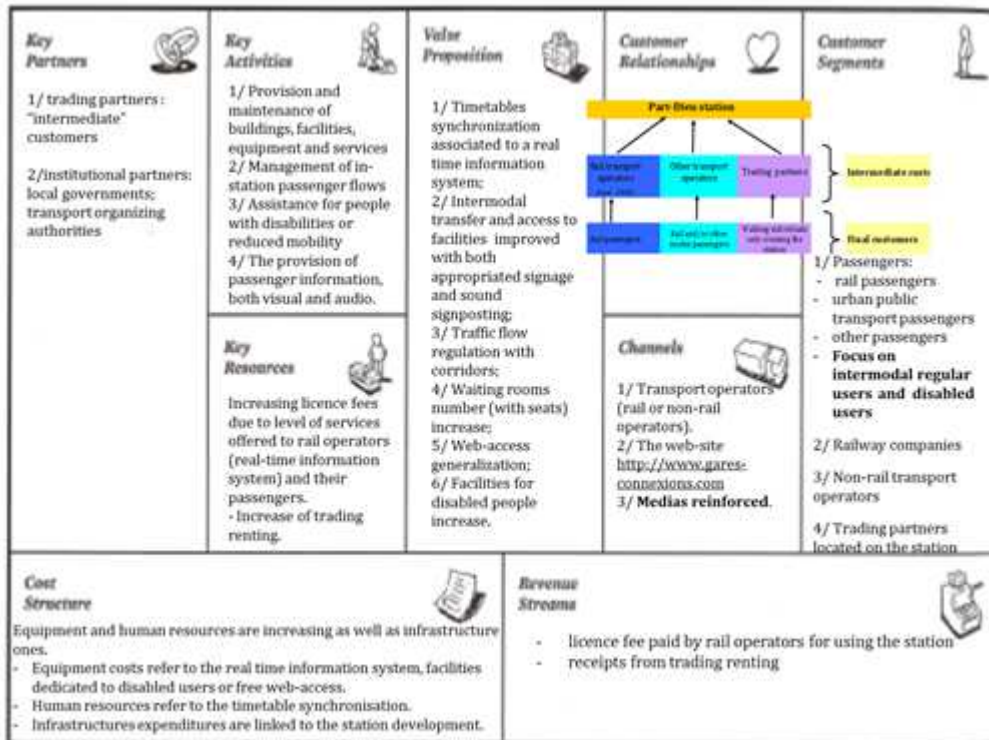


Figure 2.3 – Proposal of Business Model

2.6 Faro International Airport, Portugal

2.6.1 Brief characterisation of the Case Study

The airport of Faro is the main gateway for accessing the touristic region of Algarve, in the south of Portugal. The airport is located 5 km away from the main city in the region: Faro. The airport of Faro presents a high seasonality since it fundamentally serves the tourist activity of Algarve region which attraction lies in natural conditions such as sun and sea during the summer. Therefore, there is a structural imbalance between the IATA Summer and Winter demand.

Only road based connections are offered at the airport. The nearest train station is located in the city centre of Faro. The available transport services are: public bus, private bus (shuttle), taxi, rented-cars, or private cars.

The agents with relevancy for the definition of the business models are:

- Passengers;
- Airport of Faro Manager (ANA);
- Rent-a-Car companies;
- Taxis;
- Public Transport;

- Private Shuttle Companies;
- Hotels.

2.6.2 Changes for improved Interconnectivity

In order to overcome the current problem and to implement a truly intermodal service between the air and the land based transport services, we propose to include air-land intermodality into the value proposition of the airport. We propose to implement a flexible small-scale collective transport service integrated with the air transport, in terms of tariffs, scheduling and information. The collective transport service will provide transport to some destinations in the region of Algarve. Passengers would be offered a seamless transport journey, since their airport of origin until their final destination in Algarve. By seamless we understand no (or short) waiting time at the airport and direct transport to final destination. In Figure 2.4 we present the canvas according to Osterwalder for the new business model.

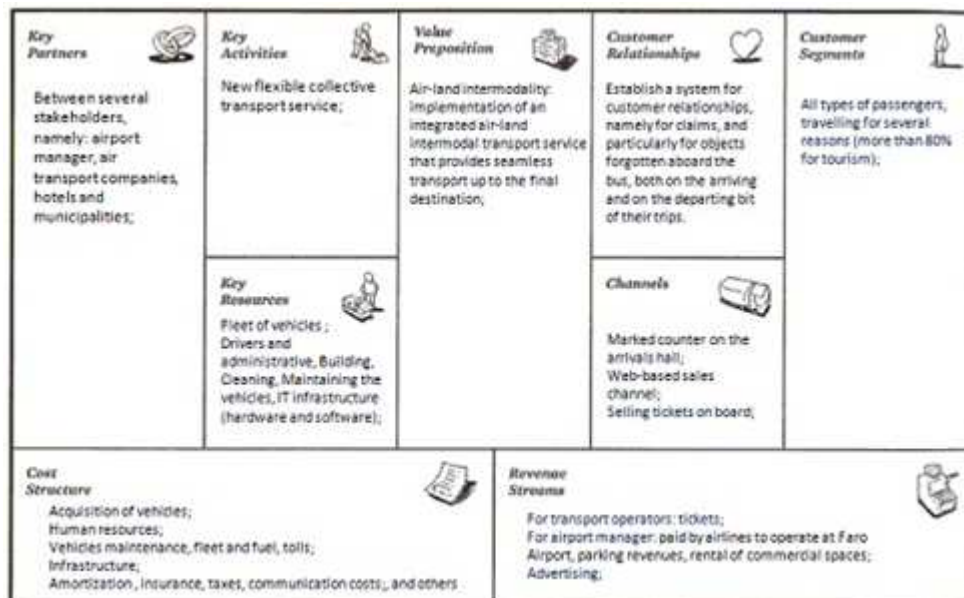
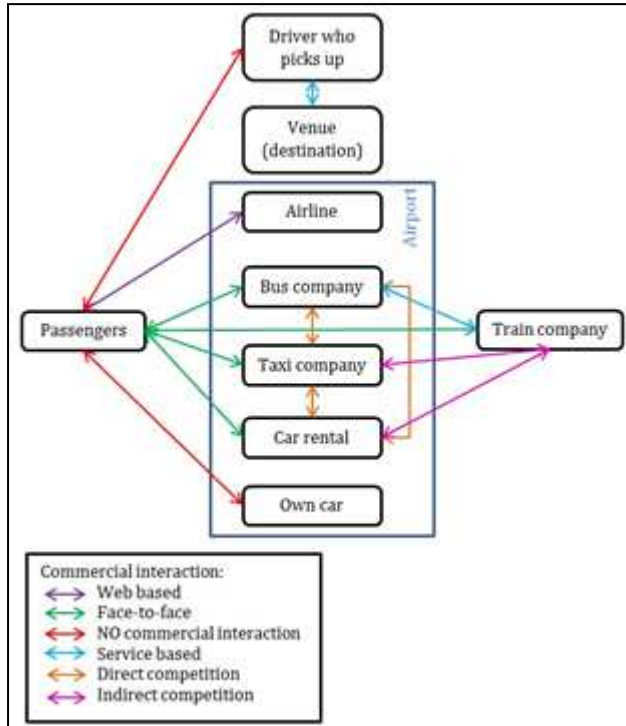


Figure 2.4 - Business model canvas for the proposal

The FCTS operator will concentrate all the information about the new service, including schedules and tariffs. The basic sales channel must be a clearly marked counter on the arrivals hall, although it is possibly useful to consider from the beginning a web-based sales channel. Another channel is foreseen, which consists in selling tickets on board aircrafts. This will imply the establishment of a commercial agreement with the air transport companies.

2.7 Antwerp Airport, Belgium

2.7.1 Brief characterisation of the Case Study



Antwerp Airport¹ is a small regional, slots free airport which mainly focuses on business travellers, but a market opportunity can be found in offering leisure flights.

To respond to the needs of the time sensitive business traveller, check-in counters open one hour before and close only twenty minutes before departure of the flight. Given the size of the airport, walking distances around and within the airport building are relatively small. Furthermore, Antwerp Airport is a site where short distance air

transport meets up with short distance land transport (car/taxi and bus). Currently, there are about 5 flights a day scheduled to London City Airport and 2 flights to Manchester, which are performed with small airplanes (Fokker 50). In the airport building there are offices of car rental companies and several taxis available. Next to the airport building, there are 500 free parking spaces and a bus stop where about every fifteen minutes there is a bus that brings the travellers to the two nearest train stations (15 min. ride).

The airport management and the carrier, CityJet, co-operate to offer an air transport connection. The other modes available do not co-operate whatsoever and offer their services independently from each other, in order to maximise their revenue and thus profit.

¹ When comparing Antwerp Airport to the other Belgian regional airports (Charleroi, Kortrijk, Liège and Ostend) one can see that Antwerp Airport represents a rather low number of passengers and tonnage.

2.7.2 Current Level of Quality and Missing Links

Currently, 75% of the passengers access the airport by car. However, the roads surrounding the airport are congested. To improve the accessibility of the airport, the use of the car has to be discouraged and the passengers have to be convinced to use the public transport more often. However, there is no direct train connection at Antwerp Airport and the other modes (bus/taxi) are underused because the services are rather poor (unreliable and expensive). Furthermore, if Antwerp Airport wants to try and attract also leisure passengers, a good accessibility is important. Improving the current public transport services and providing direct rail access would probably imply a mode shift for some of the existing customers.

2.7.3 Changes for improved Interconnectivity

Nowadays, some complaints are raised about the unreliable bus services and the expensive taxi rides. These services can be improved if the transport operators and the airport management come to an agreement concerning services levels. For example, the bus and taxi companies commit to improving their services and, in return, the airport management promotes the public transport services. Integrated ticketing, where passengers take the bus by using their boarding pass, would also stimulate the use of public transport.

On a longer term, the airport can come to an agreement with the rail services provider and a train station could be installed at the airport site. Physically this is possible, since rail tracks are running next to the airport site. Service level agreements and ticket integration are also needed here. The following canvas presents the proposed business model (Figure 2.5).

2.8 Frankfurt-Hahn Regional Airport, Germany

2.8.1 Brief characterisation of the Case Study

Frankfurt-Hahn Airport (IATA Code: HHN) is a commercial airport located in Rhineland-Palatinate to the west of central Germany. The former military airport was opened for civil flights in 1993. Since then the airport has become one of Germany's fastest growing airports especially since 1999 when the Irish low cost carrier Ryanair settled on Frankfurt-Hahn and developed the airport to one of its major airport bases. In 2010 around 3.5 million passengers and 228.000 tonnes of freight was handled at Hahn airport. Since January 2009 Frankfurt Hahn airport is owned by the federal states of Rhineland-

Palatinate (82.5%) and Hestia (17.5%) but the airport management is currently searching for private investors. At Frankfurt-Hahn airport all three levels of interconnectivity which are addressed by the HERMES project are covered, namely different transport modes (air to road), public (bus) versus private transport modes (car) as well as high (air) versus low capacity transport modes (car/taxi).

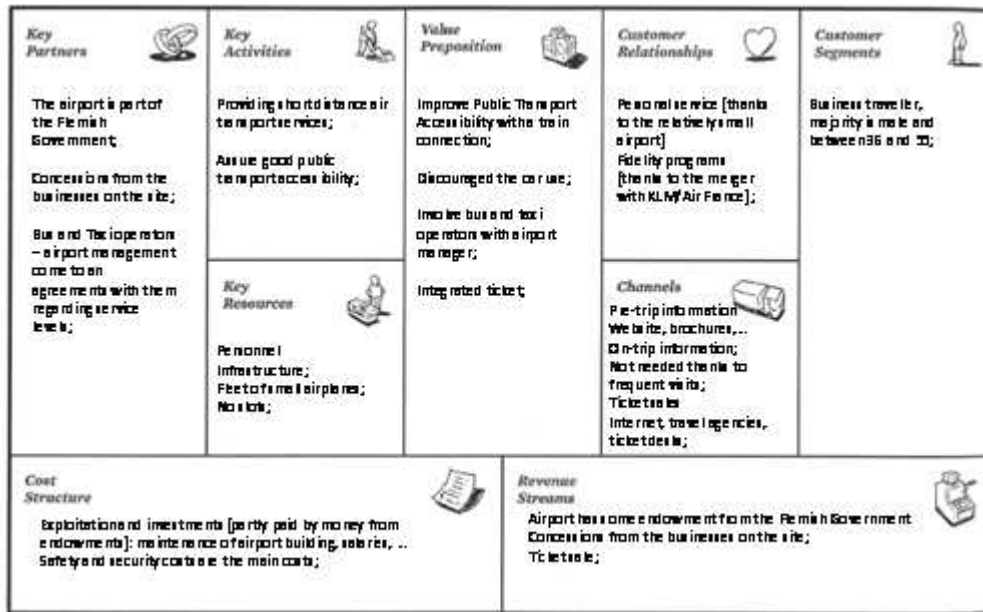


Figure 2.5 – Proposed business model

2.8.2 Current Level of Quality and Missing Links

The current level of quality at Hahn airport and especially the customers' satisfaction with space, signposting, added values, friendliness of staff, waiting times, direct services etc. is already on a very high level. Still on an acceptable satisfactory level but with much lower absolute values is the accessibility situation of Hahn airport. Customers perceive the access / egress situation as time consuming and not very satisfactory which is due to the geographical location of the airport. A rail connection is planned but still has to pass through the process of financial planning and public approval. Thus, a completion of the rail connection is not expected for the near future. The intermodality and interconnectivity gaps identified for Frankfurt Hahn airport are therefore related to HERMES Cluster 1 interconnectivity barriers which relates to improving physical interfaces.

2.8.3 Changes for improved Interconnectivity

In 2011 the existing federal road which passes by the airport has been upgraded and extended that now new and comfortable capacities for access/egress exist. Therefore,

improvements for road infrastructures are not required. Contrarily, accessibility opportunities for railway are still discussed because a former railway line passes close to the airport which is currently not in operation. A reactivation of approx. 60 km of tracks, which are single-tracked and currently inoperative, is planned (including approx. 10 km of tracks which need to be double-tracked and an airport station at Hahn). Approx. 95 Mio Euro is necessary for the connection of Hahn airport to the German railway network. Travel times between Hahn airport and connection stations to the German railway network are predicted to 90 minutes between Hahn airport and Mainz Central Station and around 125 minutes for the distance Hahn Airport – Mainz – Frankfurt Central Station which is longer than average travel times by car (around 60 minutes to the centre of Mainz and 90 minutes to the centre of Frankfurt). Therefore, travel time savings are not the driving force behind the investment plans. The main value of the proposition stems from a number of improvements, such as reduced waiting times, higher flexibility, higher reliability, lower necessity to transfer between different modes and higher comfort, which may lead to improved accessibility of the airport via public transport modes. Changes in the business model (including rail access) are illustrated in Osterwalder’s scheme hereafter.

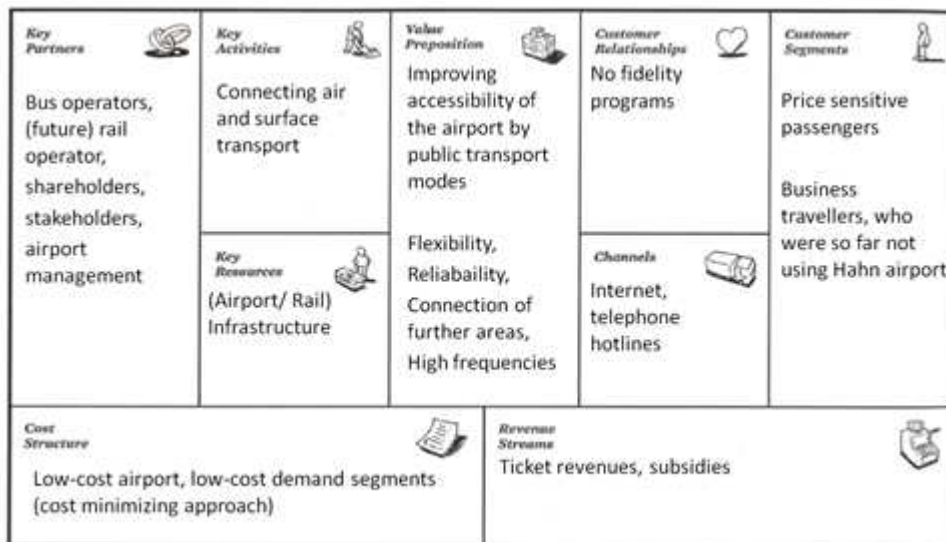


Figure 2.6 – Proposed Business Model

2.9 Stockholm Arlanda International Airport, Sweden

2.9.1 Brief characterisation of the Case Study

Stockholm-Arlanda Airport is Sweden's largest international/domestic airport located 37 km north of Stockholm, with about 17 millions of passengers per year; 13 million international passengers and 4 million domestic passengers. The airport has four aviation terminals as well as interchanges for ground transport services such as bus, car and rail services at Arlanda Airport. When it comes to parking facilities there are about 25 000 parking spaces nearby the terminals, in p-houses, in long-term parking and in private parking just outside Arlanda with free bus transport to the terminals. The case study of Arlanda-Airport covers all three levels of interconnectivity which are addressed in the HERMES project: Interfaces between different modes: air-rail, air-road, Interfaces between different type of service of the same mode: air-air and Interfaces between high capacity and low capacity mode: air vs taxi etc.

2.9.2 Current Level of Quality and Missing Links

The current level of quality at Arlanda airport (according to customer survey) is very high. It is important to point out that 76 % of the customers are satisfied and have no requirements for additional information. Improvements are possible on a very high level. In order to fulfil the emission limit and further expand the airport the stakeholders at Arlanda Airport want to increase the number of passengers who are using public transport (bus and rail modes) to and from Arlanda. Arlanda Airport has already implemented several measures.

For passengers who choose to travel by taxi, there is already a separate eco-taxi queue outside the airport terminals, in front of the other taxis. The airport's target is that all taxis that serve Arlanda Airport shall be eco-taxis by 2011. The airport also gives preferential treatment to "clean" cars, for example by allowing them to park as close as possible to the terminal for passengers. A total of 190 parking spaces were 2007 reserved for clean cars at Swedavia's parking facilities at Arlanda.

Still, there are some issues which have to be solved:

1. How to decrease emissions from passengers' cars (parking and picking-up/leaving someone at the Arlanda)
2. How to decrease emissions from employees' cars (parking)

2.9.3 Changes for improved Interconnectivity

In order to decrease carbon emissions it is important to increase usage of public transport. Our value proposition is: to provide integrated and qualitative transport services for passengers and employees and thereby offer integrated information and ticket-selling. The target is to enable passengers and employees to use bus and rail transport services to and from Arlanda Airport.

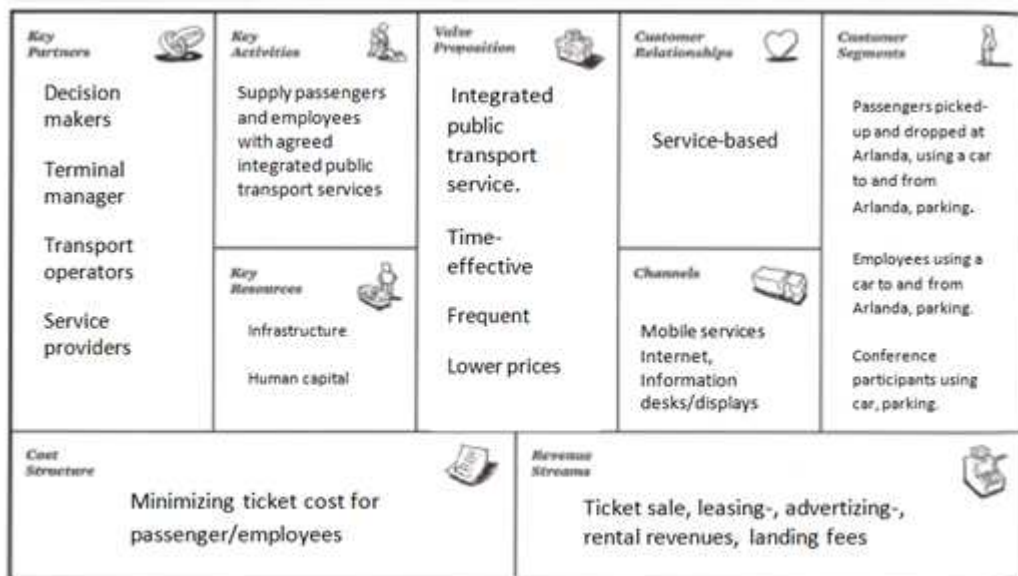


Figure 2.7 Proposed new business model

2.10 Extension of the Adriatic – Ionian corridor – from Peloponnese to Crete Greece

2.10.1 Brief characterisation of the Case Study

In the current situation, the maritime transport (ferry) services linking continental Greece -including the Peloponnese- to Crete are mainly based on the Piraeus hub port; passenger flows coming from Western and Central Europe through the Adriatic corridor and having Crete as final destination, are oriented from the port of Patras to the port of Piraeus, primarily, through the road transport network (private cars or bus services) and then ferry services to Crete. Instead of a nodal interchange, the “area” of reference for Case Study 5 is the corridor Patras- Piraeus- Crete. The examined corridor consists of two legs: a) Patras- Piraeus and b) Piraeus- Crete. Concerning the first leg (215 km) the connection is realized by bus, Car or rail. Concerning the second leg a port to port Ferry service is

offered. In the port of Piraeus three (3) private operators are activated realizing the route Piraeus – Crete. The existing connections from the port of Piraeus are to Iraklio and Chania.

The proposed case study examines the conditions for the successful creation of an alternative integrated intermodal passenger service from Adriatic- Ionian corridor to Crete through the Peloponnese, avoiding deviation through Piraeus. In addition, the future business model includes a second –enlarged- alternative, including new touristic services.

2.10.2 Current Level of Quality and Missing Links

The passenger flows from the Adriatic corridor to Crete reach the final destination via the hub port of Piraeus. The identified barriers are mainly of functional and operational “service” character, since from the physical viewpoint infrastructural connections exist and, therefore, the necessary conditions are fulfilled. The port of Patras, offers direct access to the entire Peloponnese Region. On the contrary, the maritime transport (ferry) services linking continental Greece (including the Peloponnese) to Crete are mainly based on the Piraeus hub port. There are already some established ferry lines between southern the Peloponnese and northern Crete but the service frequencies and quality are not satisfactory while the seasonal character of these flows creates wider problems of fleet optimization. Resulting from this “missing link”, the majority of passengers use the Piraeus port thus creating important trip deviations.

In the current situation, ferry operations in the Adriatic–Ionian corridor are fully independent from the other legs of the chain. Ferry services from the Peloponnese to Crete are neither completely regular nor coordinated with Patras’ ferry services. In addition, any inland (bus or train) transport service from the port of Patras to the port of Kalamata is missing. Significant opportunities exist for the improvement and coordination of these connections. Ferry services in the Adriatic–Ionian corridor steadily present a high level of service; this is not the case for ferry operations between southern Peloponnese and Crete. There is considerable space for improvement of the latter, as well as to inland connections between the ports of Patras and Kalamata.

It is revealed that the main Gap for Case 5 is the “Low level of service of current intermodal transport service”, according to WP2 classification and typology. Moreover, this corresponds to an extreme gap case since the current situation is based on successive independent mono-modal services on various legs of the corridor, neither coordinated to

each other nor integrated. The main focus of the proposed model is on the current “missing link” i.e. the inland leg between Patras and Southern Peloponnese, which needs to be integrated into the network.

2.10.3 Changes for improved Interconnectivity

The proposal of Case Study 5 deals with the development of an alternative, fully integrated intermodal transport service for passengers between Western/Central Europe through Italy and the Adriatic–Ionian corridor and Crete, avoiding deviation through Piraeus. The study examines the entire network configuration of such an integrated service, including: a) the long distance ferry transport between Italy and the port of Patras; b) the inland leg connecting the port of Patras to the southern Peloponnese and c) the medium distance ferry transport from southern Peloponnese to Crete. The proposed business model activates the “missing link” i.e. the inland leg between Patras and Southern Peloponnese.

In addition, the proposed business model is related to new touristic services. The Service Offering consist of two packages: the “direct transport to Crete” (for Non- Stop Travellers) and the “Transport and Tourism” package. The package for the Non-Stop Travellers offers the direct access from an Italian Adriatic port to Crete through the ports of Patra and Kalamata. This service will cover the missing link that exists today, minimizing the trip deviations. The “Transport and Tourism” package combines the transfer from an Italian port to Crete with a two days sightseeing tour in the Peloponnese. This package includes transportation, accommodation and sightseeing tour with one ticket for the whole chain.

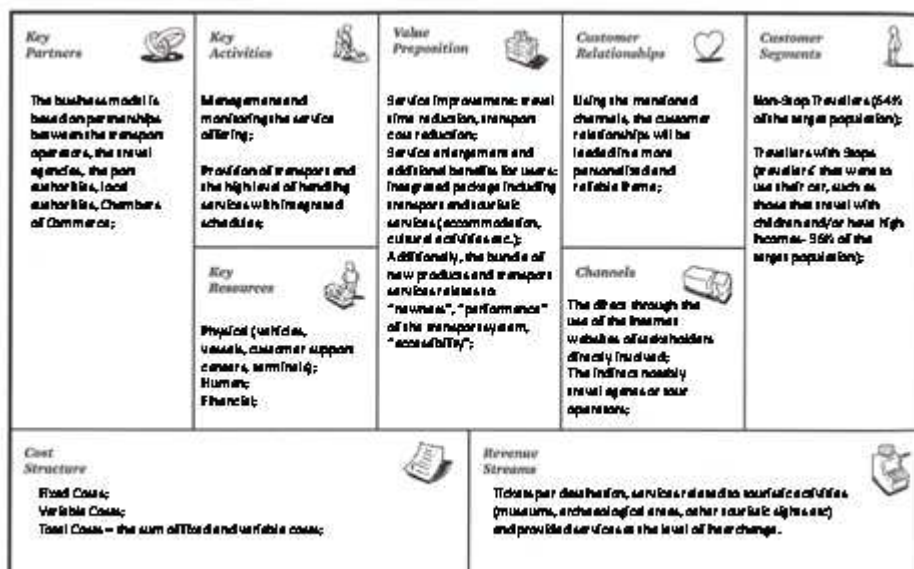


Figure 2.8 – Proposed business model

2.11 Port of Patras, Greece

2.11.1 Brief characterisation of the Case Study

The Patras Port consists of a Passengers Port which handles an important part of the total passenger's sea traffic between Greece and other countries and also of a Commercial Port. The overall international flows of Passengers for the period 1999 – 2010 reach the 1million regarding mainly the Greece-Italy connections while the national flows are almost the half of it mainly from/to the Ionian islands.

The port of Patras constitutes an intermodal hab. The main intermodal connections of the port are between long and short distance ferries with long and short distance rail, air, bus and road services. The different agents involved in this intermodal operation of the port are the Port Authority, the interurban and urban Bus Authority, the Municipality of Patras, the Shipping companies, the Passengers and the Taxi drivers.

The case study aimed at identifying the gaps of the current business model of Patras port regarding mainly the factors that influence the passenger behavior and choice in order to propose a new business model and a value proposition capable of attracting additional passenger demand in relation to the additional cost.

2.11.2 Current Level of Quality and Missing Links

According to the results of the passenger survey that took place in the port during the summer period, the overall satisfaction with the current level of quality of the offered services was high. The main problems and opportunities for the port of Patras identified concerned the physical dimension of interconnectivity, the logical (information display) and economical (integrating ticketing) as well as the different organization of some existing services (luggage handling).

Specifically a main (connectivity) problem of the port constitutes the long distance between the main port area (passengers' waiting area) and the platforms, for which the passengers are compelled to traverse carrying their luggage. This issue becomes even more critical as far as people with disabilities and elderly people are concerned. The port authority could overcome this interconnectivity barrier by putting small buses for transferring the passengers from the main port area to the platforms.

Another major issue the passengers' survey has emerged concerns the information displays and the signposting of the port. All passengers identified this issue as highly important and at the same time not sufficiently covered by the port. Low cost investments

in signs and info displays could resolve this issue and constitute an opportunity for attracting additional passenger demand in the port.

Finally, a main (institutional) problem that was identified by the passengers' as well as the stakeholders' surveys is the lack of cooperation among the transport (and the other) stakeholders of the port. This fact affects the quality of service of the port since it leads to the lack of timetables' coordination as well as integrated ticketing. The particularity of the last interconnectivity problems is that the cooperation of all involved stakeholders is a prerequisite in order to resolve them. On the contrary the previous barriers could be arranged by the terminal operator (port authority) alone.

2.11.3 Changes for improved Interconnectivity

The first two measures that must be taken in order to improve interconnectivity are the improvement of signposting and the free transfer of passengers and luggage and are strictly related to the port authority. The other two measures are integrated ticketing and coordinated timetables presuppose the close collaboration between all different agents involved. The first group of measures addresses the problem (barrier) of increased waiting times and low passenger comfort while the second group promotes interconnectivity as a whole, resulting in the enhancement of the quality of services.

The combination of the proposed measures tackle all the major barriers for the promotion of passenger intermodality in the port of Patras which are mainly related to the lack of sufficient info provision and lack of cooperation between the stakeholders (which both lead to increased transfer times).

The modifications of the business Model in relation to the aforementioned suggestions are described in detail in the next figure.



Figure 2.9 – Proposed Business Model

3 Validation of Prototypes

3.1 Introduction

The development of the prototypes of business models was based on a rigorous scientific process, organised in three phases, aiming to ensure the validity and applicability of the prototypes in other real world contexts. The process is presented below in Figure 3.1. As it is possible to observe, this process involved both Work Package 5 and Work Package 2.

The three phases are:

- Induction of the prototypes of business models,
- Deduction of the case studies' business models for improved intermodality;
- Evidences of improvement for the validation of the prototypes of business models.

Table 3.1 summarises the relevant characteristics of the case studies for the development and validation of the prototypes, also relating these elements with the three phases.

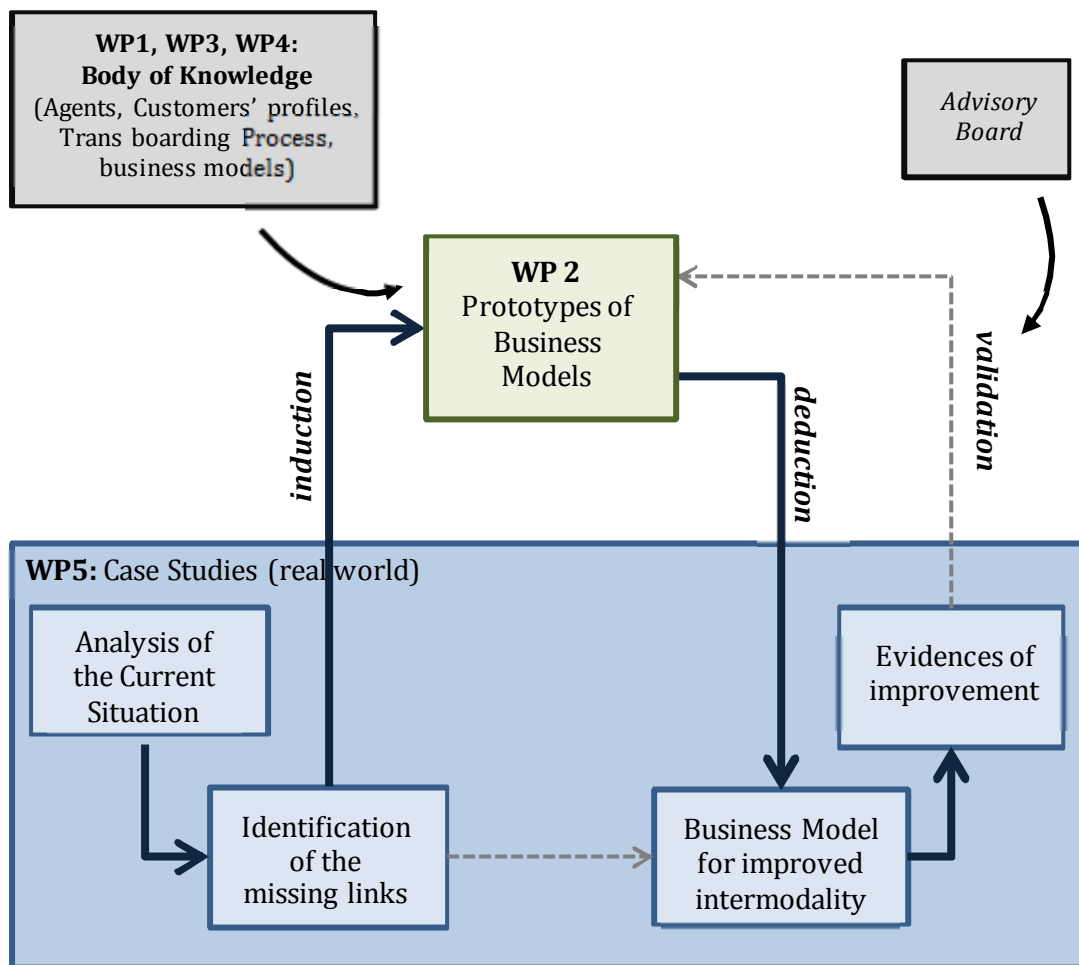
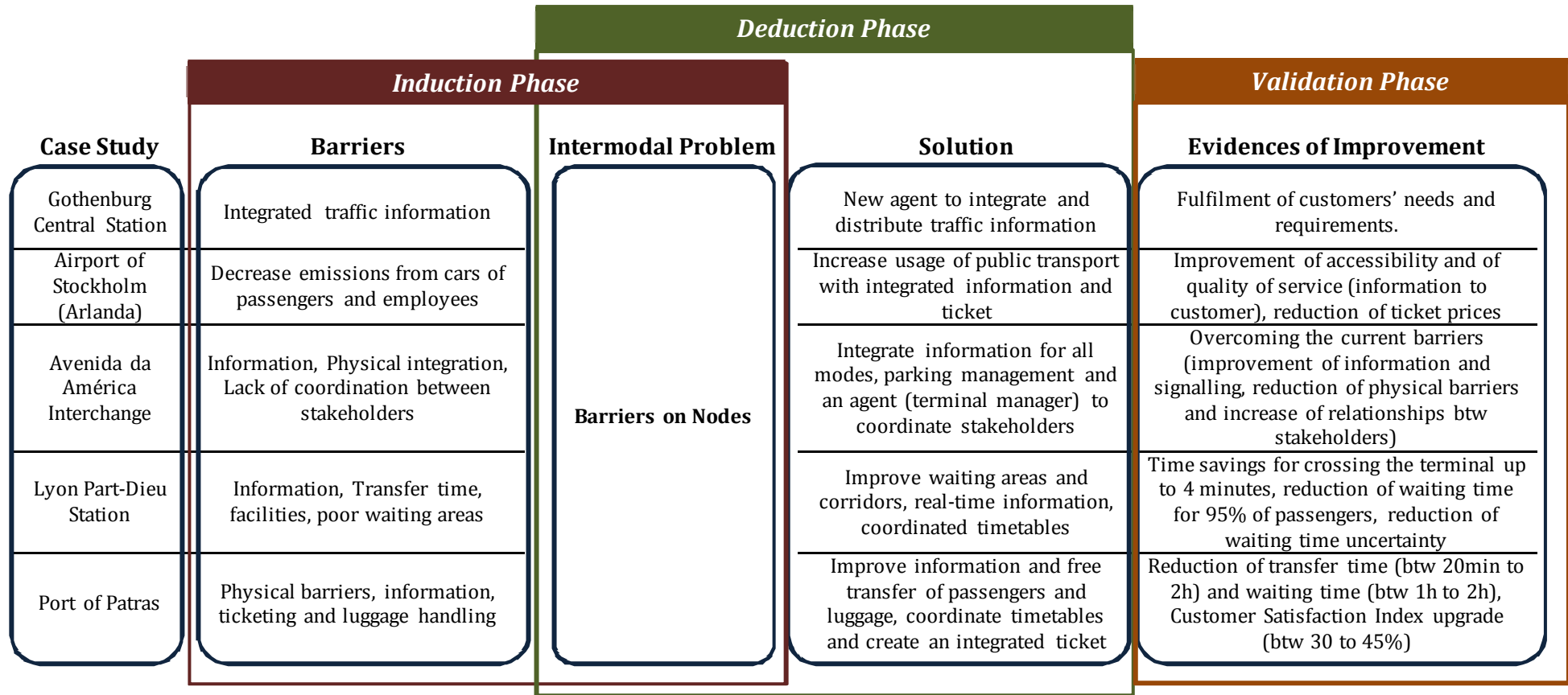


Figure 3.1 – Development and validation process of the Prototypes of Business Models

Table 3.1 – Development and Validation Phases of the Prototypes of Business Models

<i>Deduction Phase</i>				
	<i>Induction Phase</i>			<i>Validation Phase</i>
Case Study	Barriers	Intermodal Problem	Solution	Evidences of Improvement
Corridor Peloponnese to Crete	Uncoordinated schedules between ferries, missing of inland connection	Barriers on Links	Fully integrated intermodal transport service (ferry – inland connection – ferry)	Increase of passengers and reduction of transport costs
Oriente Central Station	Poor connections, Lack of information		(Initial hypothesis was not confirmed)	(nothing has been conclude)
Airport of Faro	Poor road connections, uncoordinated time-tables		Implement a intermodal land-based services (flexible small-scale collective transport service)	Estimated cost for the service is lower (up tp 50%) than the charged prices
Airport of Antwerp	Poor accessibility to airport (mainly by car through congested roads)		Improve bus services, integrated ticket, train connection	Reduction in travel time with rail connection and public transport improvement
Airport of Frankfurt-Hahn	Poor accessibility to airport		Introduce rail connection (already planned)	Reduction of waiting time, higher flexibility and increase of reliability in public transport and improvement of comfort.
Case Study	Barriers	Intermodal Problem	Solution	Evidences of Improvement
Long Distance Bus (Zaragoza + Lleida)	Information, Physical barrier between rail and bus, Manager not focus on intermodality	Barriers on Links Barriers on Nodes	Integrate information for all modes, improve accessibility between rail and bus, involve local authorities in management	Overcoming the current barriers (improvement of information and signalling, reduction of physical barriers and increase of relationships btw stakeholders)



The rationale underlying the validation process of the prototypes was the following. The prototypes were induced based on the analysis of the current (real world) case studies. Upon the induction, for each case study, new business models were deduced based on the prototypes. The potential gains (if any) in quality of the intermodal transport service achieved through the deployment of the new business models were calculated. The gains in quality are evidences of the validity of the prototypes, because the business models were derived from the prototypes.

3.2 Induction of the prototypes of business models

In this first phase, there was the induction of the prototypes of business models from the real world case studies. Induction is a process of abstraction whereby the researcher moves from the real world level towards a conceptual level. In this process, he identifies the fundamental variables and laws of interaction that rules the phenomenon.

In other words, induction is a process of moving from particular instances to general laws of interactions (abstraction). The inducted conjectures establish the causal relationships (i.e. hypothesis and theories on how the real world phenomenon works) between the fundamental variables. Because the inducted conjectures are conceptual representations of the real world phenomenon, without a concrete existence as such, they can potentially be applied to other similar real world phenomena (theory building).

The ultimate objective of induction phase in HERMES project was the development of the prototypes of business models. As explained in detail in the Deliverable of WP2, a prototype is a “thinking tool” (Osterwalder, 2010, pp 162) to support and guide the actual development of the business model. As such, a prototype does not intend to provide a rough or fixed picture of what the actual business models should be, but simply to guide and present suggestion for the design of superior business model. Consequently, the prototype must focus on the key or fundamental aspects of the business model. Furthermore, in order to maximise the usefulness of the prototype, they should contribute to overcome actual barriers that are currently precluding the performance of the intermodal transport services.

In order to achieve this objective, the works began with the identification of the barriers and sources of friction. They were classified accordingly with the dimensions identified in the works developed within Work Package 1, Work Package 3 and Work Package 4. Yet, taking into consideration that each case study presented very specific features (such as: modes of transport, scope, scale, functionalities, etc.), no universal method of analysis

could be implemented (without the risk of developing a method that was unfeasible to apply in some cases or leaving out some important features on others). Instead, a tailored method was developed and deployed in each case study².

The main barriers and sources of friction are listed in Table 3.1 (2nd Column). Through the analysis of the barriers, we could conclude about the existence of two fundamental barriers, relate with their location in the intermodal transport service, being: barriers in the links and barriers in the nodes. These barriers are fully explained in the Deliverable of WP2, in brief:

- Gap 1 - Low integration between transport services.
- Gap 2 - Inadequate intermodal transfer conditions.

The existence of two fundamental barriers resulted in the need to develop two prototypes of business models. Each one meant to overcome a specific set of barriers. The prototypes were induced based on the common characteristics of the various case studies and the works developed in Work Package 1, Work Package 3 and Work Package 4, in order to maximise their potential universality³.

3.3 Deduction of the case studies' business models for improved intermodality

The second phase in the development of the prototypes of business model corresponded to the deduction of improved business models for the case studies. Deduction conversely to induction is the process of moving from general laws to particular instances. Assuming that the general laws are true (or valid), so the particular laws are equally valid (or true) Indeed deductive arguments are sound by virtue of entailment, that is, that provided the premises are correct, it is impossible to rationally resist the conclusion.

The main objective of this phase was to develop the new business models for improved intermodality. A tailored solution, for each case study, was brought forward to overcome the key barriers and sources of friction (previously identified). Table 3.1 (4th Column) describes the solution brought forward to overcome the main barriers and sources of friction, hindering the quality of the intermodal transport service.

² Full description in the Annexes.

³ The prototypes of business models are fully described in the Deliverable of WP2.

The solution was developed in function of the Value Proposition of the respective prototype, the actual nature of the main barriers and other specific local constrains. The new business models were then developed based on the proposed solution and guided by the respective prototype. Bearing in mind that, firstly, a prototype just provides guidance (and not fixes) the design of the business models and, secondly, each case study is presents specific features, then tailored business model were developed for each case study. The business models are presented in Chapter 2 and fully described in the Annexes.

3.4 Evidences of improvement for the validation of the prototypes of business models

Recalling the steps done so far, firstly the prototypes were induced from the real world case studies and, secondly, new business models for improved intermodality were developed for each case study based on the prototypes. This final phase corresponded to the actual validation of the prototypes. This was done through the analysis of the changes in the quality or performance of the intermodal transport service resulting from the implementation of the new business model, accordingly with the following conditions:

- If gains could be expected (and calculated), then evidences supporting the validity of the prototypes were collected.
- If no gains or losses could be expected, then no evidences supporting the validity of the prototypes were collected.

The rationale is the following (Figure 3.2), the improvements in the quality or performance of the intermodal transport service were solely ascribed to the new business models (since this was the only fact changing vis-à-vis the current situation). Since the new business models were based on the prototypes, then the improvements were ultimately caused by the prototypes, establishing the evidence of validity.

The changes brought by the new business models are summarise in the 5th column of Table 3.1. As we can conclude, with the exception of the Gare do Oriente case study, in all other case studies improvements have been calculated. These improvements are evidences supporting the validity of the prototypes of business models. Consequently, we may conclude for the likely validity of the prototypes of business models.

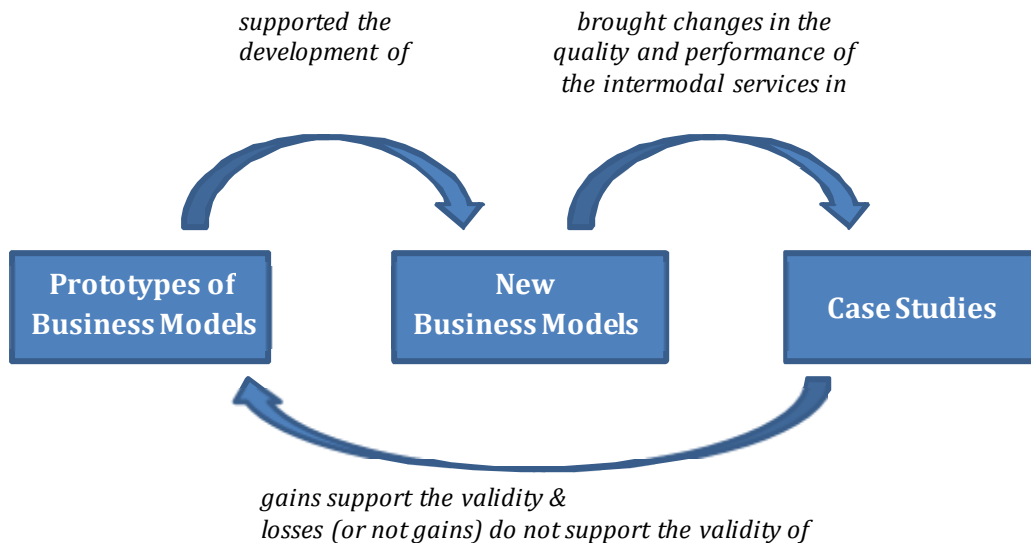


Figure 3.2 – Validation rationale of the prototypes of business models

3.5 Conclusions

This chapter explains how the validation of the prototypes of business models was conducted. The validation of the prototypes is necessary, if we aim that they could be deployed in other real world contexts.

The validation process was structured in three phases, including: induction, deduction and validation. The induction phase consisted in the identification of the fundamental key variables and laws of interactions that rule the intermodal transport service. In addition, in this step, the main barriers jeopardising the quality and performance of the intermodal transport service were identified. Two main barriers were detected accordingly with their location, being: barriers in the links and barriers in the nodes. Consequently, two prototypes of business models were inferred, based on the key variables and laws of interactions. The prototypes are presented in Chapter 2 and fully described in the Annexes.

The second step corresponded to the deduction of new business models for improved intermodality. Each case study identified different barriers for intermodality, consequently, tailored solutions had to be proposed. The solutions were inspired in the value proposition of the respective prototype of business mode. Based on this solution, on the respective prototype and on the specific constraints, a new business model was designed.

in each study. By definition the prototypes do not fix or determined a business model, but simply provide guidance in this process.

The last stage corresponded to the actual validation of the prototypes. Recalling to induction and deduction phases, we may establish a causal relationship between the prototypes and the quality or performance of the intermodal transport service. Indeed, we may conclude that any change in the quality or performance of the intermodal transport service resulted from the implementation of the new business models, which in turn was based on the prototypes of business models.

Evidences on improvements brought by the new business model were collected in all case studies, with the exception of the Gare do Oriente case study. Consequently, we may conclude that the prototypes of business models are likely valid and are ready to be deployed in other real world contexts.

4 CROSS-FINDINGS OF THE CASE STUDIES

This report summarises the work and synthesise the results of HERMES WP5 Task 5.3. This task compared and compiled the results of the Case Studies, aiming to identify the elements of validation for the prototypes of business models and provide basis for recommendations for the development of intermodal and crossmodal transport services. As such, this task serves as basis for the development of the prototypes of Business Models in WP2 and for the development of the conclusions and recommendations on good practices in WP6.

As already detailed, each case study assessed the current level of intermodality and identified the barriers for an improved intermodality. Proposals for overcoming these barriers were then brought forward and analysed.

The methodological approach deployed in Task 5.3 consisted in evaluating the business models of the Case Studies, accordingly with the framework proposed by A. Osterwalder, in two different moments, The first moment refers to the current situation of the Case Studies. The second moment refers to a situation in which a proposal of improvement has been implemented. The methodological approach aimed to infer about the changes in the building required for overcoming the current barriers, and to assess the similarities and dissimilarities of those changes. The analyses of the changes provide information in which aspects of the transport services are required for obtaining an improvement in the quality of the intermodality; while the analysis of the similarities provide information on the level

of generalisation of that change (that is: a higher level of generalisation denotes that likely other situation may be improved using the same solution).

The chapter is divided into five sub-chapters. The second chapter briefly describes the concept of business model and presents the framework of analysis as proposed by A. Osterwalder. The third chapter presents the analysis of the cross-findings for the current business model situation. The fourth chapter presents the analysis of the cross-findings for the improved situation. The analysis was divided in two parts, accordingly with the two prototypes of business models to be proposed in HERMES project. The last chapter concludes and summarised the findings of the cross-analys.

4.1 Framework of Analysis of Business Model

Osterwalder business model theoretical framework was the chosen approach to use on this project. Osterwalder et al. (2010) presents a business model canvas that exposes the rational of how an organization creates, delivers, and captures value. They define nine building blocks for the model which are the following ones:

- Customer Segment – specifies for whom are the company creating value since an organization serves one or several customer segments;
- Value Propositions – it seeks to solve customer problems and satisfy customer needs with value propositions;
- Channels – Value propositions are delivered to customers through communication, distribution, and sales channels;
- Customer Relationships – are established and maintained with each customer segment;
- Revenue Streams – result from value propositions successfully offered to customers;
- Key Resources – the assets required to offer and deliver the previously described elements;
- Key Activities – activities, distribution channels, customer relationships and revenue streams that the value proposition requires;
- Key Partnerships – some activities are outsourced and some resources are acquired outside the enterprise;
- Cost Structure – the business model elements result in the cost structure.

In the figure below it is possible to observe the business model canvas that the authors suggest that every company should fill. This business model characterization is very

complete but at the same time very simple to understand and use. That is the reason why we chose to explore the business model in transport sector according to this view of how a business model is fully characterized.

The author proposal becomes more detailed since he starts to specify each one of the nine buildings blocks.

4.2 Cross-findings of the analysis to the current business model

This chapter summarises the process of analysis and compilation of the current business model of the Case Studies. Following the framework of A. Osterwalder, presented in the previous chapter, the description is made in sequential order for the various building blocks. The main similarities and dissimilarities will be highlighted.

4.2.1 Value Proposition (VP)

Faro Airport, Antwerp Airport, Frankfurt-Hahn Airport, Zaragoza/Lleida Long Distance Bus and the Corridor Peloponnese to Crete case studies present the same main barrier to interconnectivity – a missing link. At those sites, passengers have to build their multimodal transport service, which is nothing more than a collection of individual transport legs.

Looking for the current transport services provided to and from the airport of Faro, we may conclude that, in practical terms, no intermodal transport services are offered at the airport of Faro. Instead, there is a set of independent services connected at the same location - the airport. Public transport is limited to buses since the other available modes are taxi and rent-a-car.

This is similar to the current situation described for the Peloponnese/Crete case study. Transport services of various modes -not integrated- are offered along the examined corridor. The customers themselves proceed to various modal combinations in order to reach the final destination, but the transport service on each leg of the chain is fully independent from each other. Rail, bus and car services are offered on short distance as well as on long distance, depending on the leg of the chain.



Figure 4.1 - Business model Canvas (osterwalder et al., 2010)

In Antwerp Airport passengers are not very satisfied with the public transport services such as bus and taxi. Antwerp Airport is well accessible by car since there is a large parking lot in front of the airport building. However, as on most roads in Belgium, there are traffic jams on the roads leading to the airport, so public transport needs to be improved. So we can conclude that like in the case of Faro Airport and Peloponnese/Crete case, there is a missing link.

Frankfurt Hahn airport is another example, since it currently depends on an effective operating road infrastructure as railway is currently not operating to Hahn airport. Therefore, accessibility to the airport is limited to private transport modes where car is the predominant transport mode or to public transport services that are currently limited to buses. In terms of intermodality and interconnectivity the business model was so far focused exclusively on road transport. The strategy has been to use the benefits of the small size of the airport, which assures short distances in and around the terminal and the extensive space of the former military ground, which can be used for parking facilities. Since a high percentage of a passengers used private cars, the airports interconnectivity strategy particularly targeted car users by providing cheap parking and free shuttle buses from the more distant parking facilities.

Regarding Zaragoza/Lleida Long Distance Bus, we can notice that there is also a missing link which is the integration between short and long distance services, especially between rail and bus services in Zaragoza.

Gothenburg Central Station, Arlanda Airport, Avenida de America, Lyon Part-Dieu Central Station, Port of Patras and also Zaragoza/Lleida Long Distance Bus case studies present as a main barrier to interconnectivity issues related to the terminals, or in other words the nodes. Three main problems at the nodes were identified: lack of logical integration/information, weak governance and poor physical integration.

In Avenida de America case study we can notice that the current value proposition include information provision as a main concern. Information at the site are not clear or either sufficient. There is also a lack of physical integration at the terminal and the manager entity should play a greater role than it does.

For Zaragoza-Lleida case study we can noticed that information about all transport is a weakness too, but here there is no integration of information between transport services at all. Local transport authorities should be more involved in station

management and there should be collaboration between terminal manager and operators.

In Arlanda Airport there is an agreement between transport market players to persuade people to use public transport to and from the airport. For those who choose to ride in a taxi, there is already a separate eco-taxi queue outside the airport terminals, in front of the other taxis. The airport's target is that all taxis that serve Arlanda airport shall be eco-taxis by 2011. The airport also gives preferential treatment to "clean" cars, for example by allowing them to park as close as possible to the terminal for passengers. Nevertheless, there is still a lot of room for improvement when it comes to public transport. Today, driving a car is the only alternative from a number of areas so the goal is to find solutions to decrease usage of cars to and from Arlanda. Here we clearly have a governance issue.

Gothenburg Central Station customers are not satisfied with the quality/service (through survey answers). The main reasons for this could be the winter problems together with the fact that Swedes tend to be self-critical. January 1st 2012 the Swedish passenger transport will be fully de-regulated. This implicates that more stakeholders and operators will be present at Gothenburg Central Station. The risk of getting a situation with less coordinated information and confusion among travellers is high. Expectation is to maintain/ increase the information quality and standard at the station in order to maintain/ increase the customer satisfaction. Here the two main problems are lack of logical integration and governance.

In Port of Patras case study 'components' of the value proposition that are affected directly or indirectly by the port authority are summarizing, lack of logical integration, poor physical integration and governance.

Part-Dieu station has four main Value Propositions that rely four main capabilities: attraction of rail operators (mainly the SNCF) to provide regional, national and high-speed rail transport services; to attract non-rail transport operators and to propose a multimodal mobility (station proposes connections between rail transports, urban public transports, non-urban public transports, cars and self-service bicycles); improve quality of the services for passengers (which includes passengers' information in the station but also real-time remote information) , signage improvement for different transport modes, shops and other services, offers different types of in-station services and shops. The three main problems identified are: poor physical integration, logical integration and governance.

4.2.2 Customer Segments (CS)

Since all these case studies are related with transport terminals or transport connections passengers are diversified. Nevertheless, for some case studies the main customers' group are travelling for tourism and in others for business purposes.

Faro Airport, for example presents more than 80% of customers travelling for tourism in 2010, and more than 53% with family. The most common choice of land transport to leave the airport is rent-a-car (33%). This airport has more than 5 million passengers per year. On the contrary, Antwerp Airport mainly serves business people.

Young passengers use Frankfurt-Hahn as airport for leisure trips (e.g. vacation or family visit). Business customers which are a primary segment especially of airports only play a minor role at Hahn airport. The self-image of Hahn is a low cost airport which mainly serves price sensitive customers which is underlined by the trip purpose distribution.

In Zaragoza/Lleida case study we can notice the two types of passengers with the same weight depending on the transport mode. For example, the main passengers' travel purpose for high speed railway is business. Nevertheless, for bus trips the main travel purpose is private reasons where we can include tourism. This is consistent with the principle that tourism passengers are more price sensitive than business passengers, so they choose a cheaper transport mode.

4.2.3 Channels (CH)

Channels that transport providers and other stakeholders of transport services use to communicate with customers are multiple. However, channels to communicate with their passengers are similar. In many case studies we notice that all channels are proprietary and transport provider based. This means that passengers need to use several channels to get information on (and eventually buy the tickets from) the diverse transport providers.

Internet is the most common channel mentioned in the case studies. Airports, Central Stations and transport operators have websites with information about their services. Faro Airport, Antwerp Airport, Frankfurt-Hahn Airport, Arlanda Airport, Part-Dieu Station, Gothenburgh Central Station are good examples of this.

Terminals (or interchanges) where transport providers operate represent a common site to spread information through audio or posters. This is the case, for example, of Avenida de America and Zaragoza/Lleida.

Information desks are also a common channel. All airports have this service and information desks are managed by airlines and land transport operators. Moreover, terminals like Zaragoza/Lleida, Gothenburg Central Station and Part-Dieu for instance, also present these information desks.

Information displays about transport schedule are present at all airports. Moreover, stations like Part-Dieu or Gothenburgh for instance, also have these displays to spread information about railway schedule. The main difficulty identified is the integration of the information of different transport operators.

In the case of Port of Patras for instance, advertising through media represents another mentioned channel to spread information and raise awareness of transport service.

4.2.4 Customer Relationships (CR)

We did not identify strong relationships between stakeholders and their customers besides the actual delivery of the service in general. Several stakeholders do not have any kind of relationship. Those who have invested in building some sort of relationship with their customers use the typical fidelity programs or offer cheaper bundle services. Nevertheless, there are few examples of customer relationship worth of being pointed out.

For instance, in the Corridor Peloponnese to Crete ferry services have rewards programs for frequent flyers travellers which offer benefits in the form of discounts, participation in promotions and special offers.

In Port of Patras case study it was noticed that major customer relationship is assured by desk information and ticket-selling desks. This is also the case at Gothenburg and Part-Dieu stations, where besides that automated services there are also personnel available at the sites to sell tickets and give information. Studied airports (Faro, Arlanda, Antwerp and Frankfurt-Hahn) also present this kind of desks that are managed by airlines. Nevertheless, Antwerp Airport as well as Faro Airport has little interaction with customers. This is also true for Frankfurt-Hahn Airport since the demand is represented by highly price-sensitive customers so customer relationship programs do not play a role and are not offered by the air transport operators (since they are LCCs). Arlanda Airport presents more interaction with customers since it has a great desk to provide assistance and information to passengers concerning land transport modes.

Some transport operators offers cards and discounts for frequent customers. For instance, in Avenida de America case study it was noticed that bus company “Alsa” offers a card that by using it customers have discounts in tickets and other advantages. Spanish railway operator, RENFE, presents discounts for frequent users and young or elderly customers as it was noticed in Zaragoza/Lleida case study.

4.2.5 Revenue Streams (R\$)

Transport providers operating at studied sites main revenue stream is ticket sells. Transport operators feed terminal’s revenue streams since they pay for using the interchange as it is noticed, for example in Zaragoza/Lleida and Avenida de America case studies. In the last case study it is also highlighted that the rental of commercial premises and the parking revenues are other revenue streams which is mentioned in other case studies such as Gothenburg Central Station but here is also pointed out that municipalities contribute with more than 40% of the revenues.

Government participation is also mentioned in Antwerp Airport, since the Flemish Government contributes with subsidies. Advertising revenue is relatively low for all case studies where this revenue is mentioned for example Gothenburg Central Station, Faro Airport and Avenida de America.

The main revenue streams for the airport are fees paid by airlines to operate. This is the case of Faro, Arlanda, Frankfurt-Hahn and Antwerp airports. Aviation revenues include landing fees, passenger charges, etc. As it is noticed on Arlanda case study, other important revenues come from non-aviation revenues such as parking fees, commercial site rentals, office rentals, advertising spaces and commercial services. Stakeholders who want to operate at the interchange have to accept both conditions and fees set up by the terminal manager.

4.2.6 Key Resources (KS)

On each case study there are several stakeholders and each one of them has its own set of key resources depending on its business and positioning in the transport chain. In general terms the resources can be divided into the following types in the case studies:

- Vehicles;
- Infrastructure
 - Physical infrastructure (includes: airport terminal, parking lots, parking stands, front desks, etc);

- Technological infrastructure (includes: websites, communication systems, etc);
- Human Resources.

The only case study where it is explained that key resources explanation are not appropriated is the Corridor Peloponnese/Crete.

4.2.7 Key Activities (KA)

The key activities are related with the provision of transport services. Like the previous building block, the activities are function of the stakeholder's positioning in the transport chain for each case study.

In general terms, key activities described for all case studies can be divided in the following ones: customer oriented activities or stakeholder (or company) oriented activities. Customer oriented activities are pointed out as being information and marketing, tickets selling, transferring (resting and foods areas), transport service, parking. Company oriented activities are mainly financing and economics (related with the assessment of costs, revenues, financing and similar activities), planning and management operations (schedule, services), monitoring, maintenance and security.

4.2.8 Key Partnerships (KP)

Few partnerships have been identified in the case studies. Nevertheless, some case studies are more fruitful than other in this aspect.

Airport case studies (Arlanda, Faro, Frankfurt-Hahn and Antwerp) present only partnerships between airlines and airport manager. In Avenida de America and Zaragoza/Lleida no partnerships were pointed out. Public companies are the responsible for managing the terminals and they do not have any partnerships with other companies. However, we can noticed that transport providers that operate at the site do have contractual agreements with the terminal managers.

Frankfurt-Hahn and Arlanda presents evidences of schedule integration between airlines and land transport and in the last case, it is also noticed that are several transport operators providing the same service which increases competition but not partnerships. This is a particularity of Arlanda airport case study.

4.2.9 Cost Structure (C\$)

It is possible to observe through all case studies that the cost structure is specific of each stakeholder. Yet, the main items of the cost structure for all case studies include: human resources, vehicle and fleet (acquisition, rental and maintenance), infrastructure (planning, building and maintenance), fuel, debt, amortization and other taxes.

Transport operators are described in the case studies in interesting in minimising costs with the four main items mentioned above and indirectly in increase revenues.

It is also important to noticed that government /public subsidies paly a major role for some case studies cost structure such as Antwerp Airport, Arlanda Airport, Avenida de America and Zaragoza/Lleida.

4.2.10 Conclusions

The eleven case studies of HERMES project offer a rich and diverse set of possible situation of intermodality and cross-modality in the European Union. We thus may conclude that the business models can be representative of many other cases across the European Union.

The value proposition is the less similar building block among the case studies, which is understandable since it reflects what the transport operators and local authorities aim to deliver and provide to its passengers; and, this varies considerably across Europe (as the notion of public services also changes).

In what concerns the remaining building blocks, there are multiple similarities, which is expectable since the majority is related with the public transport of passengers. The Customers Segments are essentially the same, since in public transport there tends to be no customer segmentation. The communication channels and customer relationships are also rather similar, existing in some case special features such as frequent passenger programmes.

Interestingly few partnerships have been identified, which evidences the lack of integration between transport operators. Naturally, the lack of stable partnerships is a factor precluding the implementation of intermodal or co-modal services.

Finally, in what concerns the cost structure, unfortunately information was hard to find and collect, owing to confidentiality issues. Even so, from the analysis of the case studies, we may conclude that, although the items of cost structure are similar, their relevancy changes considerably from case to case.

In summary, the framework of analysis proposed by A. Osterwalder offer a very interesting approach, and it adequately characterises the various dimensions of the business model. From the analysis of the various business models, the building blocks that exhibit great dissimilarity was the value proposition and customer relationships. The remaining are fairly similar, with of course the natural differences resulting from the different nature of the case studies.

4.3 Cross-findings of the analysis to the proposed business model

The barriers to intermodality have identified, for each case study, as already explained in this document. Proposals for improvement have then been made to overcome those barriers. Such proposal would result in changed to the current business model. This chapter summarises the works undertaken to analyse and cross-compare the changes in the business models.

As explained in Deliverable 2, based on the properties of the current business model, two type of barriers to intermodality have been identified: one regarding the absence of connections at the terminals and another concerning the poor physical conditions at the terminals to change between transport modes. Based on these findings, two prototypes of business models were defined according to the main gap in the case studies. One of the prototypes regards issues with links (absence of connections at the terminals) and the other is related with issues in nodes (difficulties at the terminal to change between transport modes).

The case studies concerning the issues on the links are:

- Long Distance Bus (Zaragoza + Lleida)
- Corridor Peloponnese to Crete
- Oriente Central Station
- Airport of Faro
- Airport of Antwerp
- Airport of Frankfurt Hahn

The case studies concerning the issues on the nodes are:

- Gothenburg Central Station
- Airport of Stockholm – Arlanda
- Avenida da América Interchange
- Long Distance Bus (Zaragoza + Lleida)
- Lyon Part-Dieu Station

- Port of Patras

For the sake of clarity, we adopted this division for the presentation of the findings. One of the case studies (Zaragoza + Lleida) presents both types of issues. For that reason it will be included in both analyses.

4.3.1 Case studies with issues on the links

The prototype of business models of issues with links represents one of the main barriers to intermodality that is related to the absence of connections at the terminals.

4.3.1.1 Value Proposition (VP)

Regarding the value proposition of the six case studies named above we can observe that besides the specification of each one of them, they all propose a new connection or transport service to improve interconnectivity.

4.3.1.2 Customer Segments (CS)

No changes are expected in the building block Customer Segment vis-à-vis the current situation. However, since Corridor Peloponnese to Crete is related with a connection that currently does not exist, potential customer segments were estimated.

4.3.1.3 Channels (CH)

There are no relevant changes at the channels. New transport connections will be provided by a new transport operator or by an existing one. Nevertheless, common channels mentioned to sell tickets, provide information, etc, will remain the same.

It mentioned in the case studies that integration tickets are a concern of the new proposals since it is our understanding that this option improves interconnectivity.

For Faro Airport case study it is pointed out that besides the basic sales channel another foreseen channel is selling tickets for the new transport service on board aircrafts. This will imply the establishment of a commercial agreement with the air transport companies.

4.3.1.4 Customer Relationships (CR)

New transport provider that will operate the proposed services in these case studies must establish a system for customer relationships, namely for claims, and particularly for objects forgotten aboard the bus, both on the arriving and on the departing bit of

their trips. Sells and information could also be provided through desks to increase customer relationships as it was mentioned on the case studies.

However, no significant changes are expected in the building block Customer Relationships vis-à-vis the current situation.

4.3.1.5 Revenue Streams (R\$)

General consideration regarding this building block for the case studies with issues on the links are that transport provider, which will operate the new proposed service, would collect all the direct revenues from the various sales channels. Additional sources may include advertisement on board the vehicles or on the internet website. This consideration does not include Oriente Central Station.

No significant changes are expected for Revenue Streams vis-à-vis the current situation.

4.3.1.6 Key Resources (KS)

The service proposed will entail a new set of resources, including: fleet of vehicles (mini-bus, mini-vans), drivers and other administrative staff, building (administrative office, for parking, cleaning and maintaining the vehicles) and IT infrastructure (hardware and software) if we consider that a new transport operator will provide this service. Case studies that present as a solution to the current interconnectivity problems a new transport connection mentioned these resources.

If a current transport provider decides to operate this service, we can observe despite some resources are already available it will be necessary to invest in the fleet or employees (for instance, drivers).

4.3.1.7 Key Activities (KA)

The introduction of a new transport connection generates a new key activity at the sites for all case studies. This new activity will be similar to other activities related with transport operators and their positioning in the market.

We expect in all case studies a change in transport structure (that we can observe on the agents graphical representation of the case studies) and an improvement on interconnectivity at the sites.

4.3.1.8 Key Partnerships (KP)

Key partnerships are different and specific for all case studies. However, we can notice that transport operators have to fulfil certain requirements of transport regulation and also to accept some aspects in order to operate at the terminals.

Some new partnerships are suggested in the case studies, for example in Faro Airport with hotels and other transport operators. But once again, those are specific of each case study.

4.3.1.9 Cost Structure (C\$)

No significant changes are expected for Cost Structure vis-à-vis the current situation. However, new transport operator will represent a new player at the transport operators' stakeholder group that will contribute to the terminals cost structure, for example.

4.3.1.10 Conclusions

Interestingly all case studies bring forward a similar value proposition for overcoming the current barrier to intermodality: implementation of a new service to improve interconnectivity. This may evidence that this value proposition could be an interesting solution to overcome the current barriers.

The implementation of a new service will have some impact in the key resources and eventually in the key activities, but no major changes have been identified. Likewise, the channels and customer relationships have not been significantly affected. The key activities will remain essentially the same, as the new service is also a transport service.

No changes in the customer segments are expected which denotes that the proposal of business model may not attract different types of passengers, but it will attract more passengers besides improving the quality for the existent ones, which by itself is very positive.

Of importance is the fact that again not significant changes are expected in the revenue streams building blocks; yet, the new service will naturally imply changes in the cost structure. Therefore, we may conclude that for the viability of the intermodal service, efficiencies will have to be generated. In parallel, as explained above, more customers may be attracted into the transport system.

4.3.2 Case studies with issues on the nodes

This prototype of business model is related with poor physical conditions at the terminals to change between transport modes. This is another main barrier to intermodality.

As mentioned above, Long Distance Bus (Zaragoza + Lleida) is the only case study that presents both kinds of issues: with links and also with nodes.

4.3.2.1 Value Proposition (VP)

The most referred changes in the value proposition are related with integration of information, governance, and physical integration.

Information and signalling improvement through real-time information displays are mentioned in all case studies with issues on the nodes: Avenida de America, Zaragoza/Lleida, Port of Patras, Gothenburg Central Station and Part-Dieu station. As we can notice, this is most important action in the value proposition to improve interconnectivity. It is important to highlight that information improvement is the pillar of the new proposal for Gothenburg Central Station.

Interchange websites with schedules information and schedule coordination between transport modes operating in interchange are also two important referred measures, especially in Avenida de America and Zaragoza/Lleida case studies.

Governance improvements are also pointed out in the case studies but details are specific for each one. Cooperation between transport operators and among them and the terminal manager are also mentioned on these six case studies. Cooperation between transport operators is important to achieve schedule coordination and integrated tickets. As it is mentioned in Zaragoza/Lleida case study, local transport authorities should be more involved with terminal managers. This entity could manage and checked cooperation between transport operators.

Apart from Gothenburg and Port of Patras case studies, physical integration is pointed out as an issue to mitigate with the new value proposition.

4.3.2.2 Customer Segments (CS)

No changes are expected in the building block Customer Segment vis-à-vis the current situation. Nevertheless, with the improvements of interconnectivity at the sites it is expected an increase demand of customers.

4.3.2.3 Channels (CH)

Since the six case studies pointed out improvements on logical integration of information, channels will be subject of change. Information displays with real-time integrated information, suggested for instance in Avenida de America and Zaragoza/Lleida case studies, represent a new channel that currently do not exist.

Despite website is mentioned in all case studies as a channel of information, only in the case study of Port of Patras it is suggested ticket sell through it.

Besides these changes, no other significant alterations are expected on channels building block comparing with the current situation.

4.3.2.4 Customer Relationships (CR)

Customer relationship is service-based. Customers can interact at the sites with transport providers or terminals managers as it was described for the current situation. The channels, especially the website will improve customer relationship but no significant changes are expected.

4.3.2.5 Revenue Streams (R\$)

Revenue streams of transport operators are expected to increase for the six case studies, due to a rise of customer demand as it is pointed out on Port of Patras case study.

If integrated tickets are implement, revenue streams should not decrease but origin should change since customers will not be the direct source (other entity will manage the shares). Besides this, no other significant changes are expected on revenues streams building block when comparing to the current one.

4.3.2.6 Key Resources (KS)

As it is mentioned in Gothenburg Central Station case study, information is going to be the key resource. Human resources needed can be following: information architectures, IT-technicians, marketing managers, staff at the site and office. Most of these resources are already available at the site (for example, offices, marketing managers)

No significant changes are expected for Key resources vis-à-vis the current situation.

4.3.2.7 Key Activities (KA)

Here the results are specific of each case study, but some similarities where found. Major activities will be: gather information, integrate information from different transport operators and to distribute integrated information to the customers. This is

valid for each one of the six case studies, since all of them mentioned information improvements.

Besides this, no significant changes are expected for Key Activities vis-à-vis the current situation.

4.3.2.8 *Key Partnerships (KP)*

The most common partnerships among the six case studies are related with transport operators, terminal managers and public decision makers. But they are specific of each case study, so there are no relevant similarities to point out.

4.3.2.9 *Cost Structure (C\$)*

The cost structure might be a challenge. One important cost structure is the share of revenues as it mentioned on Gothenburg Central Station case study. Probably, the new agents (Traffic Information Brokers) are going to be private companies and these are going to charge for integrating the information. Information management is a very large cost for many companies and it is necessary to find solid financial solutions. This also important for Zaragoza/Lleida, and Avenida de America case studies.

4.3.2.10 *Conclusions*

Like in the other case studies, the value proposition is the building block that shows more difference vis-à-vis the current situation. Yet, conversely to the other cases, different value propositions have been proposed to overcome the current barriers. Furthermore, the most referred changes in the value proposition are related with integration of information, governance, and physical integration. Integration of information is related with improving the readability of the terminal stations (in particular, directions and information on arrivals and departures), the physical integration is related with improving the accessibility to the passengers, in particular to those with reduced mobility. The integration governance is related with the need to improve the relationships between transport operators, terminal managers and local authorities in order to provide a better quality services to passengers. Consequently, multiple barriers may occur in the terminals (nods), which denotes that conversely to the problems with the links, there might be no universal or more general solution for tackling the problems with the nodes. In addition, it also evidences that solving the problems in nodes are probably more difficulty to solve than solving problems with links.

Other building block that presents considerable evolutions vis-à-vis the current situation is the channels. In all case studies substantial improvements have been denoted. Likewise, the case studies, whose problems are related with the governance, also exhibit evolutions in the building block key partnerships.

The building key partnerships is improved in the case studies, whose barriers are related with inadequate governance or poor relationship between stakeholders (as the case of Avenida da America Interchange Station).

In what concerns the remaining building blocks (customers segments, customer relationships, revenue streams, key resources and key activates) no significant changes have been introduced comparing with the current situation.

4.4 Conclusions

This report summarises the analyses and works produced in Work Package 5 of HERMES project. This Task compiled and compared the results of the case studies aiming to identify the elements of validation for the prototypes of business models and provide basis for recommendations for the development of intermodal and crossmodal transport services. As already detailed, each case study assessed the current level of intermodality and identified the barriers for an improved intermodality. Proposals for overcoming these barriers were analysed.

A case study is a research technique that aims to investigate - *study* - an instance - *case* - of a given real world phenomenon. In a case study, the instance is analysed within its contextual conditions (that is: the object of analysis is not analysed within controlled conditions); therefore no bias results from the research process.

Case studies are very useful in instances where the frontier between the object of analysis and the context is not clear cut (Yin, 2003, pp 13). Intermodal transport is a typical situation, as its efficiency and performance are highly related with contextual conditions (such as: legal environment, demand properties, physical infrastructure, etc).

Additionally, case studies are particularly suitable in the analysis of the underlying mechanisms and causes, or the behavioural nature of the object of study. Indeed, Yin (2003) writes that case studies have distinct advantage “when a ‘how’ or ‘why’ question is being asked about a contemporary set of events, over which the investigator has little or no control” (pp 9). This was the case of HERMES project. As a matter of fact, the main purpose of the project was the development of prototypes of business models for improved intermodal transport, linking long with short distance transport. Additionally,

the development of a business model, accordingly to Osterwalder's framework of analysis, requires a deep understanding of multiple dimensions of the business – intermodal transport – and its context. The case study methodology provides the flexibility and tools to obtain the required information in an unbiased and clear manner.

Yin (2003) identifies four main stages in the execution of a case study, being:

- The first phase is the design stage where the outline of the case study is drawn. This outline contains all the subsequent steps and tasks necessary to accomplish the inquiry. Therefore, in function of the specific objectives of the case study, the outline should depict the propositions and unit of analysis, the tools and techniques to deploy, and make reference to criteria to interpret data and findings. The quality of the design of the case study will ultimately define its very success (Yin, 2003, pp 19 and 21).
- The second stage is the conduction of the case study, whereby data on the object of analysis is collected from the real world. Researchers may use one or more of the various sources of data and evidences already explained (Yin, 2003, pp 83 and 97).
- The third stage corresponds to the analysis of the data collected. "Data analysis consists of examining, categorising, tabulating, testing, or otherwise recombining both quantitative and qualitative evidence to address the initial propositions of a study" (Yin, 2003, pp 109), in order to fulfill the initial goals of the case study.
- The final stage corresponds to reporting of the case study. The report represents the descriptive memory of the entire process of research conducive to the conclusions meanwhile achieved (Yin, 2003, pp 141).

The Case Studies were briefly presented in Chapter 2 and are detailed in the Annexes. A total of eleven Case Studies have been developed in HERMES project. They are now listed:

1. **Case Study 1:** Gothenburg Central Station (Sweden);
2. **Case Study 2:** Arlanda International Airport (Sweden);
3. **Case Study 3:** Avenida de América Interchange Madrid (Spain);
4. **Case Study 4:** Long distance bus services connected with high speed with high speed rail services (Spain);
5. **Case Study 5:** Extension of the Adriatic-Ionian ferry corridor from Peloponnese to Crete (Greece);
6. **Case Study 6:** Gare do Oriente Interchange Station and Connection with Linha do Norte Railways (Portugal);
7. **Case Study 7:** Faro International Airport (Portugal);
8. **Case Study 8:** Antwerp Airport (Belgium);
9. **Case Study 9:** Port of Patras (Greece);

10. **Case Study 10:** Part-Dieu Station at Lyon (France);
11. **Case Study 11:** Frankfurt-Hahn Airport (Germany).

The Case Studies were chosen to provide an accurate and reliable picture of the current state of intermodality and interconnectivity across the European Union. Factors taken into consideration in this process included:

- Geographical Coverage,
- Intermodal Transfer Point,
- Modes of transport involved,
- Potential barriers and missing links.

Although the multiplicity of countries, with different culture and backgrounds, is one of the main sources of the European Union's richness and diversity, it is also a root for the problems affecting intermodal transport. For example: the legal frameworks, the institutional arrangements or the business environment still remains different between the member states. Also, the language barrier or the diversity of the ticketing systems are still an important factor undermining the performance of intermodal transport. HERMES case studies were developed in seven European Union member states, including:

- Belgium (Case Study 8),
- France (Case Study 10),
- Germany (Case Study 11),
- Greece (Case Studies 5 and 9),
- Portugal (Case Studies 6 and 7),
- Spain (Case Studies 3 and 4) and
- Sweden (Case Studies 1 and 2).

The case studies provide good coverage of the central and western European Union reality, as well as, northern and southern member states. Therefore they offer a comprehensive picture of the current level of development of the intermodal transport and interconnectivity in the European Union.

The intermodal transfer points are key in the production of intermodal transport services, since they provide the opportunity for the passengers to change between modes of transport. Inadequate transfer points will reduce the level of interconnectivity and, consequently, the efficiency of the intermodal transport service. On the other hand, these points are designed according to the properties of the modes of transport that will operate. Naturally, different modes of transport will imply different designs and functionalities. Therefore, the requirements for an adequate interconnectivity depend on the type of the transfer point. Looking now to HERMES case studies, we have three types of intermodal transfer points, being:

- Airports (Case Studies 2, 7 and 11);
- Maritime Ports (Case Studies 5 and 9);
- Terminal Stations (both bus and rail terminals) (Case Studies 1, 3, 4, 6, 8 and 10).

These represent the vast majority of the intermodal transfer points within the European Union.

Recalling the scope of HERMES project as being the issues involving intermodal transport at the connection between long and short distance transport services, we can that the case studies embrace most of the possible combinations available and all the typical ones. The next scheme (Figure 4.2) presents the coverage of the modes of transports by each case study.

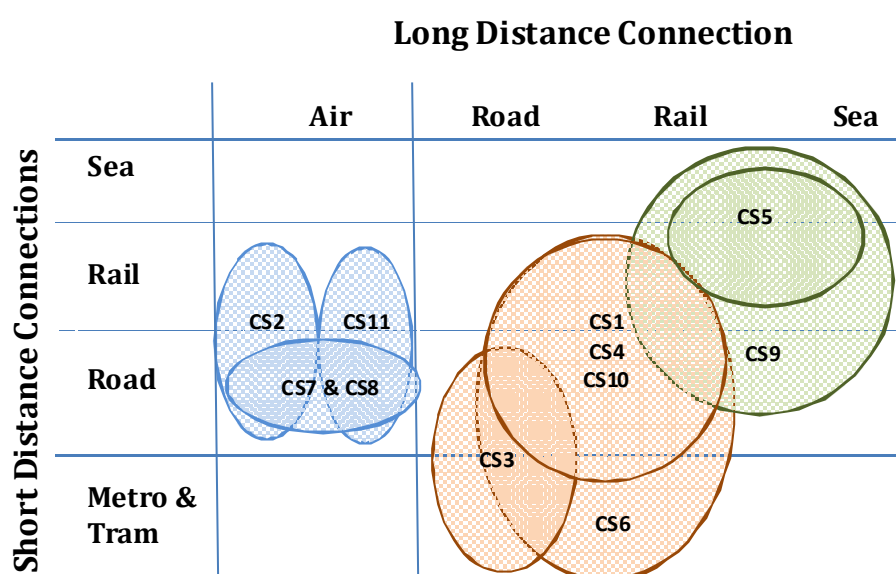


Figure 4.2 – HERMES Case Studies modal Coverage

The Case Studies cover the majority of the possible intermodal combinations. In practical terms, some of the combinations (such as: sea and air) are practically non-existent in the European Union and therefore of little relevance.

In terms of the barriers and missing link for improved intermodality and interconnectivity, the case also cover the following categories: physical barriers, logical barriers, economical barriers, contractual barriers, institutional barriers, and legal and regulatory. Most case studies exhibit more than one barrier; therefore all barriers are conveniently addressed. For example purposes, we now link each barrier to a case study:

- Physical Barrier (Case Study 10),
- Logical Barriers (Case Study 7)
- Economical barriers (Case Study 5)
- Contractual Barriers (Case Study 3),
- Institutional barriers (Case Study 4)
- Legal and Regulatory Barriers (Case Study 2).

Figure 4.3 and Figure 4.4 and summarize the overall perspectives of the four major stakeholder groups (i.e. Decision Makers, Terminal Managers, Transport Operators and Users' Associations) with reference to the importance assigned to barriers and measures.

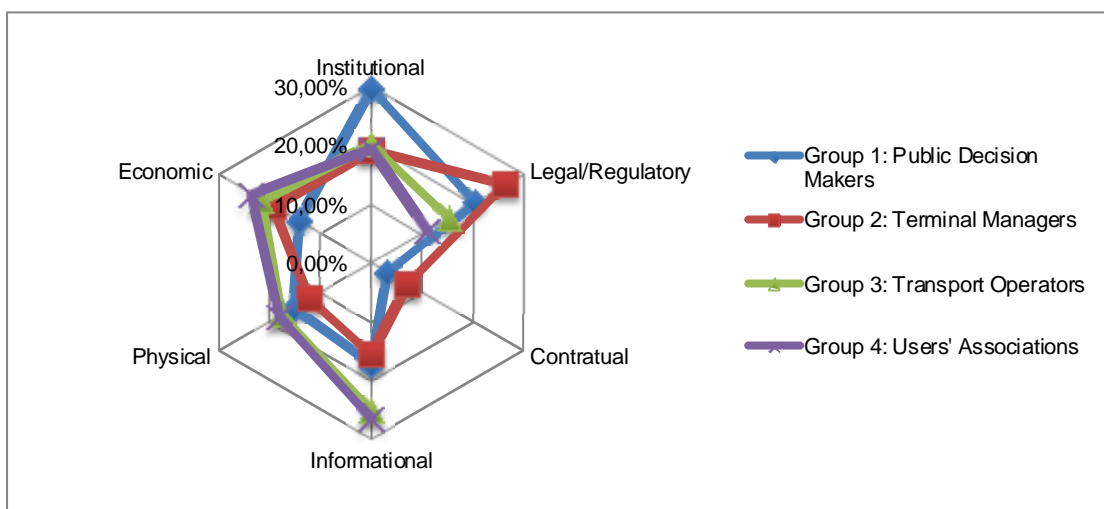


Figure 4.3 - Barriers by HERMES Domains as perceived by stakeholder groups

By studying the graphs, there seems to be some level of agreement between the stakeholder groups with respect to barriers. That is, all stakeholder groups have similar perceptions of the barriers to intermodality. The views of Transport Operators and Users' Associations almost coincide and both these groups place particular emphasis on "Information". Likewise, the perceptions of barriers are similar in the case of Terminal Operators and Decision Makers, emphasized, however, by their respective context. "Legal/regulatory" barriers are emphasized by the Terminal Operators, while "Institutional" ones are the focus of Decision Makers.

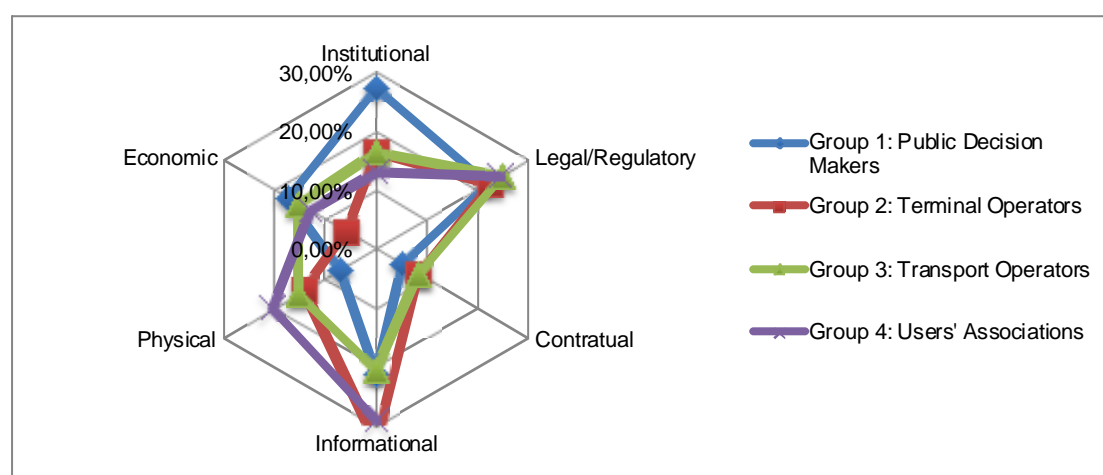


Figure 4.4 - Measures by HERMES Domains as perceived by stakeholder groups

When considering measures, the various stakeholder groups have different perceptions, reflecting, probably, their varying expectancy of the efficiency /impact of the proposed measures. Terminal Operators and Users' Groups emphasize "information". All agree upon "Legal/Regulatory" measures, while Decision Makers continue to emphasize "Institutions". Contractual issues are the less perceived as barriers and measures. Notably, "Information" stands as a key barrier and a key, perceived, measure towards intermodality.

The information collected with the case studies provides a valuable and reliable source for a better understanding intermodal transport and interconnectivity at several levels, including:

- Barriers and missing links (regulatory, legal, physical, market-related, etc.) for an improved intermodality,
- Good practices and success cases of interconnectivity,
- Current business models in operation,

Table 4.1 - HERMES Cases: Barriers, Measures and Value Propositions Summary

	Barriers Addressed						Measures Proposed/Impacted						Central theme of Value Proposition
	I	LR	C	IF	P	E	I	LR	C	IF	P	E	
Faro International Airport, air/road	*	*	*	*			*	*	*	*			New Transport Operator (FCTS)
Antwerp Airport, air/road	*			*			*			*	*		Cooperation between Terminal Manager & Transport Operator
Frankfurt-Hahn Regional Airport, air/road/(rail)				*	*	*				*	*	*	New Transport Operator (rail)
Stockholm Arlanda International Airport, air/road/rail	*	*										*	Cooperation between Terminal Manager & Transport Operator
Gothenburg Central Station, road/rail				*						*			New agent cooperating with all transport operators
Avenida de America Interchange Madrid, road/rail	*			*	*		*			*	*		Cooperation between Terminal Manager & Transport Operator
Lerida-Zaragoza, road/rail	*	*	*	*	*	*	*	*	*	*	*	*	Cooperation between Transport Operators & Terminal Managers
Gare de Oriente Interchange Lisbon, road/rail													
Intermodal Network of Lyon Metropolitan Area, road/rail	*	*	*	*	*	*		*		*			New agent cooperating with all transport operators
Peloponnese-Crete, road/ferry			*	*		*	*			*	*	*	New Transport Service
Port of Patras, road/rail/ferry			*	*	*	*			*	*	*	*	Cooperation between Terminal Manager & Transport Operator

Key:Barriers/ Measures: I : Institutional; LR: Legal and regulatory; C: Contractual; IF: Informational; P: Physical; E: Economic

Table 4.2 - HERMES Case Categories

Categorization by		
Transport Sector	Value Proposition Subject	Value Proposition Central Theme
Airport cases	Node	New Agent
Faro International Airport, air/road	Stockholm Arlanda International Airport, air/road/rail	Faro International Airport, air/road
Antwerp Airport, air/road	Gothenburg Central Station, road/rail	Frankfurt-Hahn Regional Airport, air/road/(rail)
Frankfurt-Hahn Regional Airport, air/road/(rail)	Avenida de America Interchange Madrid, road/rail	Gothenburg Central Station, road/rail
Stockholm Arlanda International Airport, air/road/rail	Lerida-Zaragoza, road/rail	Intermodal Network of Lyon Metropolitan Area, road/rail
Station Cases	Intermodal Network of Lyon Metropolitan Area, road/rail	Peloponnese-Crete, road/ferry
Gothenburg Central Station, road/rail	Port of Patras, road/rail/ferry	Enhance Cooperation
Avenida de America Interchange Madrid, road/rail	Link	Antwerp Airport, air/road
Lerida-Zaragoza, road/rail	Faro International Airport, air/road	Stockholm Arlanda International Airport, air/road/rail
Gare de Oriente Interchange Lisbon, road/rail	Antwerp Airport, air/road	Avenida de America Interchange Madrid, road/rail
Intermodal Network of Lyon Metropolitan Area, road/rail	Frankfurt-Hahn Regional Airport, air/road/(rail)	Lerida-Zaragoza, road/rail
Maritime Cases	Peloponnese-Crete, road/ferry	Port of Patras, road/rail/ferry
Peloponnese-Crete, road/ferry		
Port of Patras, road/rail/ferry		

- Demonstration on how, based on the current business, to design improved business models for intermodality.

These cases have proposed a variety of prototypes addressing the specific needs of the respective cases, i.e. measures to address barriers. These are presented in summary in Table 4.1 below.

As expected all value propositions include the measure of “Information”. In one case, Gothenburg Central Station, it is the principle focus. When it comes to the focus of the value proposition, two main subjects are recognized: the node and the link. The link seems to be the emphasis of regional cases with less developed networks or “missing” operators/services. In

more central nodal cases, especially due to de-regulation, there may be a significant supply of transport operators but cooperation is not regulated or existing competition limits the overall potential offer to users. In these cases, the central theme of the Value Proposition is cooperation between all agents in the node. When the number of agents does not support cooperation an Agent is proposed.

Following the above, the HERMES case studies may be categorized as follows (Table 4.2):

- By Transport Sector
- By the subject of the Value Proposition, that is if it reflects on a transport node or link
- By the central theme of the Value Proposition

The present section looks into how barriers and measures were addressed by the HERMES cases. Figure 4.5 and Figure 4.6 are developed by giving equal value to each aspect addressed/considered by the business models. The figures describe the overall approach.

With respect to barriers, as a group of cases, they seem to present a rather equal approach to barriers. In practice this indicates that the sample of HERMES cases was well selected so as overall to have addressed all barriers in an equitable manner (see Figure 4.5).

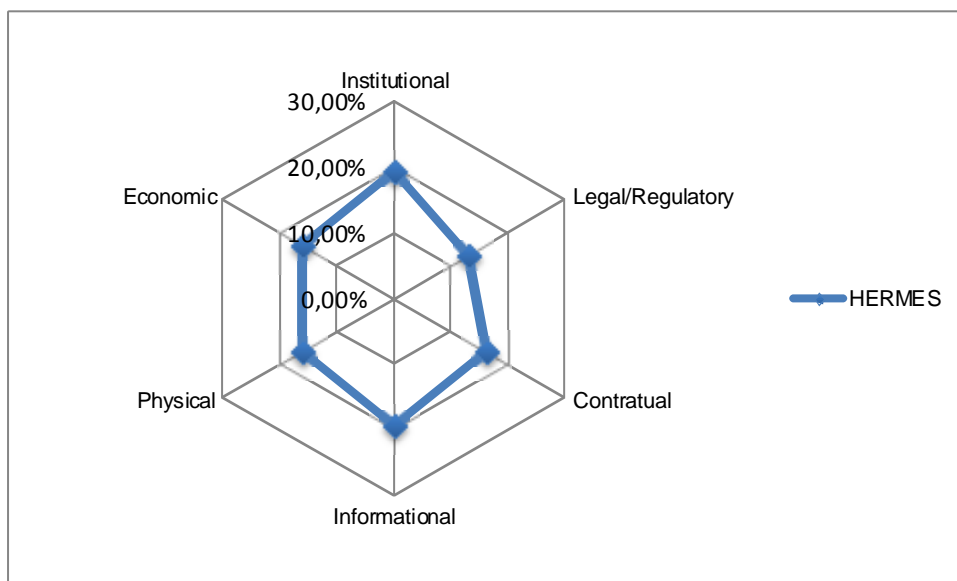


Figure 4.5 – Barriers addressed by the HERMES Cases

When considering the measures applied in the HERMES value propositions, as expected there is a considerable emphasis on “Information” but less than generally perceived by the various stakeholder groups on “institutional” and Legal/Regulatory” measures. “Physical” measures were proposed to a greater extent, then all stakeholder groups perceived as.

This is in line with the scope of the HERMES Value Propositions, i.e. to identify the gaps in seamless intermodal transfers. The major issues under this requirement between the various transport networks/ operators are:

- Physical integration
- Schedule integration – requires cooperation
- Information integration – requires cooperation
- “Logical” integration – requires cooperation

These “cooperations” are meant to reduce the need for “institutional” and Legal/Regulatory” measures as perceived by the various stakeholder groups.

If these “cooperations” are not feasible due to the competition in the node, then a introduction of an independent agent (eg. Gothenburg Central Station) presents the alternative.

Missing links between networks were addressed by the introduction of a new flexible transport service provider. In most cases the reason behind this missing link was the lack of “added value” required to present an economically feasible alternative. In all HERMES cases missing links were proposed in connection with additional services, which provided this potential of a viable service. In all HERMES value propositions, the economic aspect was well addressed and this is evident in Figure 4.6. By comparison, the stakeholder groups give lesser emphasis to this aspect.

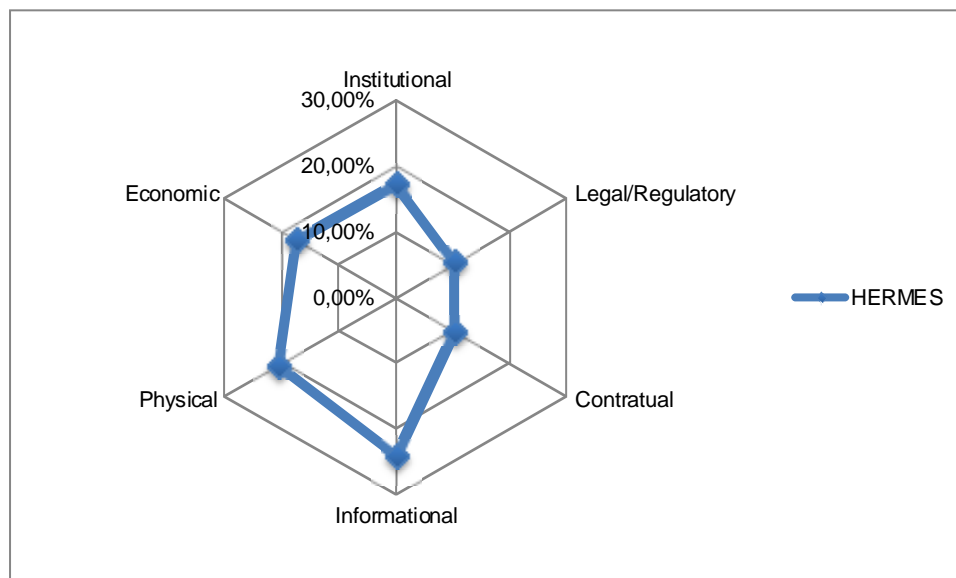


Figure 4.6 - HERMES Value Proposition Measures

A final, but still, very relevant outcome of the case studies is the presentation and demonstration of use of multiple methodological tools (such as: stated and revealed preference analysis, surveys, interviews, economic analysis, forecasting, etc.) for data collection and analysis. In addition, through the study of the case studies, the reader not only learns how to deploy these

methods not only to understand the current business model but also on how to develop new ones

In what concerns HERMES project, the Case Studies provided information for the design and validation of the prototypes of Business Models for improved intermodality. The methodological approach deployed in Task 5.3 consisted in evaluating the business models of the Case Studies, accordingly with the framework proposed by A. Osterwalder, in two different moments. The first moment refers to the current situation of the Case Studies. The second moment refers to a situation in which a proposal of improvement has been implemented. The methodological approach aimed to infer about the changes in the building required for overcoming the current barriers, and to assess the similarities and dissimilarities of those changes. The analyses of the changes provide information in which aspects of the transport services are required for obtaining an improvement in the quality of the intermodality; while the analysis of the similarities provide information on the level of generalisation of that change (that is: a higher level of generalisation denotes that likely other situation may be improved using the same solution).

Alexander Osterwalter's proposal offers an interesting, intuitive and comprehensive framework for the analysis of the business model. The framework considers nine building blocks, being: value proposition, customer segments, channels, customer relationships, revenue streams, key resources, key activities, key partnerships, and cost structure).

The analysis to the current business model offers some interesting conclusions. Firstly, the value proposition is the building block that differs the most between the case studies, which reflects the diversity of the case studies, it also reflects the natural differences between the strategies of the transport operators and local authorities. Secondly, no significant differences have been recorded between the remaining building blocks. This evidences a similarity of the operation and management between case studies. The Customers Segments building block is essentially the same, since in public transport there tends to be no customer segmentation. The communication channels and customer relationships are also rather similar, existing in some case special features such as frequent passenger programmes. Thirdly, few partnerships have been identified. Taken into consideration that intermodal transport is based on integration between transport operators, terminal operators and other stakeholders, the few partnerships evidence a lack of integration between stakeholders. Naturally, the lack of stable partnerships is a factor precluding the implementation of intermodal or co-modal services.

The analysis to the improved business model considered the existence of fundamental barriers to intermodality: concerning the links and concerning the nodes. The case studies concerning the issues on the links are Long Distance Bus (Zaragoza + Lleida), Corridor Peloponnese to Crete, Oriente Central Station, Airport of Faro, Airport of Antwerp, and Airport of Frankfurt Hahn. The case studies concerning the issues on the nodes are: Gothenburg Central Station, Airport of Stockholm – Arlanda, Avenida da América Interchange, Long Distance Bus (Zaragoza + Lleida), Lyon Part-Dieu Station, and Port of Patras.

The main conclusion from the analysis to the improved business model focused on the links is a similitude in the proposal of value proposition for overcoming the current barrier to intermodality, that is: implementation of a new service to improve interconnectivity. In addition, the proposed business models do not imply significant changes in the remaining building blocks, with the exception of the cost structure that is affected with the introduction of the new service. No changes in the customer segments are expected which denotes that the proposal of business model may not attract different types of passengers, but it will attract more passengers besides improving the quality for the existent ones, which by itself is very positive. The implementation of a new service will have some impact in the key resources and eventually in the key activities, but no major changes have been identified. Likewise, the channels and customer relationships have not been significantly affected. The key activities will remain essentially the same, as the new service is also a transport service.

Looking now into the analysis of the business models focussed on the nodes, the main conclusion is a lack of a single value proposition (as occurred with the other cases). Indeed, several value propositions have been proposed related with integration of information, governance, and physical integration. Integration of information is related with improving the readability of the terminal stations (in particular, directions and information on arrivals and departures), the physical integration is related with improving the accessibility to the passengers, in particular to those with reduced mobility. The integration governance is related with the need to improve the relationships between transport operators, terminal managers and local authorities in order to provide a better quality services to passengers. Secondly, another building block that presented considerable evolutions vis-à-vis the current situation is the channels. In all case studies substantial improvements have been denoted. Likewise, the case studies, whose problems are related with the governance, also exhibit evolutions in the building block key partnerships. Thirdly, no relevant changes were identified in the remaining building blocks.

Comparing the results of the two analyses we may reach several conclusions. Foremost, in the set of cases with issues on links the proposed value proposition is rather similar across case studies. This may evidence a similarity of the barriers causing problems in the links and, therefore, the likely existence of a solution to overcome it. Conversely, in the cases with issues on the nodes multiple of value propositions were proposed. This evidences that the barriers causing problems on the nodes are multiple and more complex than those causing problems in the links. Also, it evidences that a generalisation of the solutions is not likely possible for this type of cases. Consequently, it also evidences that solving the problems in nodes are probably more difficulty to solve than solving problems with links.

Another conclusion is that the proposed business models do not required major changes in the remaining building blocks (the changes result from the new value proposition), evidencing that improvements in the intermodality level may be possible to achieve with well-defined and precise changes in the business model.

Finally a note to the framework of analysis proposed by A. Osterwalder that offers a very interesting approach and it adequately characterises the various dimensions of the business model.

The main purpose of Work Package 5 was to support the development and validation of the prototypes of business models in the Work Package 2. The prototypes of business models are conceptual objects and therefore detached of any real world connection. Consequently, they can be deployed in any real world situations, as long as their conditions are met. No other output was foreseen and, therefore, developed.

Nevertheless, the case studies provide by themselves, as already explained in the previous pages, valuable information in methodological terms. All case studies were conducted following a well-defined methodological approach. This was done for two reasons: first, to guide and focus each partner on the important action to do and, second, to ensure that the results of the case studies were comparable and therefore could be utilised in the development and validation of the prototypes. As such, the methodological approach to develop case studies is an outcome of HERMES project that can be directly applied in any other situation. The method is made of 9 steps that is here briefly listed:

1. Main features of the site,
2. Method for that collection,
3. Identification of the stakeholders,
4. Identification of the intermodality problems,
5. Description of the current value proposition,

6. Description of the current business models,
7. Current level of service and customer satisfaction,
8. Analysis for improvement of interconnectivity,
9. Action for improvement of interconnectivity.

Although the case studies being valuable sources of information about real world situations and providing excellent examples of how to analyse and improve the quality and performance of the intermodal transport service, their results are not necessarily deployed elsewhere. Furthermore, the case studies were developed to support the induction of the prototypes of business models and subsequently to support their validation. Therefore, owing to these specific objectives, the findings of the case studies are hardly applied elsewhere.

Furthermore, the improved business models were tailored to the specific conditions of each case, resulting from the direct application of a prototype of business model. Therefore, in other real world situation, the same reasoning should be applied (that is, to applied the prototype of business model) and do not attempt to use the results of the case studies. This is the very reason for each case study to have its own business model.

Final, we must say that the actual results of each case study can also be applied in different contexts, provided that some conditions of transferability are met. This is not within the scope of HERMES but several other projects have produced methodologies on how to transfer solution between cities, countries or sectors (e.g. Macário and Marques within CIVITAS I). In this case, we need to ensure that each particular receptor has conditions for implementation of the envisaged business models, and which adjustments might be required.

5 REFERENCES

5.1 Literature

ANA – Aeroportos de Portugal, S.A. (2008). Annual Traffic Report.

BALMAIN, Emmanuelle, 2008, Le développement de l'intermodalité à l'échelle de l'aire métropolitaine lyonnaise. Projet REAL : Réseau Express de l'Aire métropolitaine de Lyon. Project presentation. Available on [http://www.certu.fr/fr/Syst%C3%A8mes de transports-n26/Transports publics-n71/Transports publics urbains et peri urbains-n701/IMG/pdf/Atelier 3 Presentation REAL CERTU.pdf](http://www.certu.fr/fr/Syst%C3%A8mes%20de%20transports-n26/Transports%20publics-n71/Transports%20publics%20urbains%20et%20peri%20urbains-n701/IMG/pdf/Atelier_3_Presentation_REAL_CERTU.pdf)

Berglund S, Pädam S, Sandberg L (2008). Rapport: Vägtullar vid Arlanda flygplats. WSP - Analys & Strategi.

Blauwens, G., De Baere, P. & Van de Voorde, E. (2008), *Transport Economics Third Edition*, Antwerpen, De Boeck, 519 p.

Bracht, H.J. (2007), Eine falsche Minimallösung, State Parliamant Rhineland-Palatinate, <http://www.landtag.rlp.de/icc/Internet-DE/sub/a1d/a1d401ce-5775-9311-33e2-dcbf983c6eac,,,a>, September 8th 2011.

Bracht, H.J. (2009), Zu viel Zeit bei zentralem Verkehrsprojekt verschenkt, State Parliamant Rhineland-Palatinate, <http://www.landtag.rlp.de/icc/Internet-DE/sub/9f9/9f940193-d1c3-e421-33e2-dc86d35f8f46,,,aaaaaaaa-aaaa-aaaa-bbbb-000000000014&page=6&pagesize=10&startmon=11&startyear=2009.htm>, September 8th 2011.

CHAM, L., DARIDO, G., JACKSON, D., LAVER, R., SCHNECK, D., 2006, Real-time bus arrival information systems return on investment study. Technical report, Federal Transit Administration

Departement Mobiliteit en Openbare Werken (Department of Mobility and Public Works) (2010), *Jaarverslag '09 Luchthaven Antwerpen - Annual report '09 Antwerp Airport*, Antwerp, 40 p.

Departement Mobiliteit en Openbare Werken (Department of Mobility and Public Works) (2010), *Luchthaven Antwerpen; Statistisch Jaarboek 2010 – Antwerp Airport; Statistical Report 2010*, Antwerp, 19 p.

Eurostat (2011), Detailed air passenger transport by reporting country and routes (avia_par), http://epp.eurostat.ec.europa.eu/portal/page/portal/statistics/search_database, September 15th 2011.

Fluhrer, T., Szimba, E., Siegele, J. (2011), Barriers to Intermodality and Interconnectivity of Passenger Transport, Deliverable D4, HERMES High Efficient and Reliable ArrangEMENTs for Cross-modal Transport, 7th Framework Program, DG Research.

Frankfurt Hahn airport (2009), Flight schedules of operating airlines from Frankfurt Hahn airport – December 2009.

Frankfurt Hahn airport (2010), Results of passenger surveys between 2006 and 2010.

Frankfurt Hahn customer survey (2010), Customer survey at Frankfurt Hahn airport conducted in November 2010.

FRIES, Ryan ; DUNNING, Anne-E ; CHOWDHURY, Mashrur A., 2009, Traveler's value of real-time transit information. Transportation Research Board 88th Annual Meeting.

Gares & Connexions, 2011, Fiche descriptive de la gare de Lyon Part-Dieu. Available on <http://www.gares-connexions.com>.

Luchthaven Antwerpen - Antwerp Airport, *Antwerp Airport Magazine 09*, Antwerp, 29 p.

MEAUX, Marie-Line, 2009, Nœud ferroviaire lyonnais, rapport d'étape N° 006680-01, 63p. Available on

http://portail.documentation.developpement-durable.gouv.fr/cgedd/document.xsp?id=Cgpc-OUV00000939&qid=sdx_q0&n=1&q=&depot=notices

MISHALANI, R.G. ; McCORD, M.M. ; WIRTZ, J., 2006, Passenger Wait Time Perceptions at Bus Stops: Empirical Results and Impact on Evaluating Real-Time Bus Arrival Information. *Journal of Public Transportation*. Vol. 9, No. 2, pp. 89-106.

Navarrete, F., Ortuzar, J. de D. (2010), Subjective valuation of the transit transfer experience: The case of Santiago de Chile, Department of Transport Engineering and Logistics, Pontificia Universidad Católica de Chile, Santiago de Chile.

Nilsson, A (2005). Marktransporter till och från Arlanda. Thesis 127. Lunds Tekniska Högskola.

Ortúzar, J. de D., Willumsen, L.G. (2011), Modelling transport, Fourth Edition, , John Wiley & Sons Ltd., Chichester.

Région Rhône-Alpes Region, Département du Rhône, Département de l'Isère, Grand Lyon, Communauté urbaine de Villefranche, Communauté urbaine du Nord-Isère, SYTRAL, SNCF, RFF, 2005, Développement de l'intermodalité à l'échelle de l'aire urbaine lyonnaise : Projet « REAL » Réseau Express de l'Aire urbaine Lyonnaise, 26p.

RFF, 2011, Noeud Ferroviaire Lyonnais. Groupe de synthèse des besoins. Document de travail provisoire. Available on

http://www.darly.org/darly-ftp/doc/cedrul/2010-07_reseau-ferre_v3b.pdf Rheinland-Pfalz

Takt – Reaktivierte Strecken, <http://www.der-takt.de/ueber-den-takt/takt-2015/streckenreaktivierung-2015/>, September 15th 2011.

RFF, 2010, Noeud Ferroviaire Lyonnais. Available on

http://www.rff.fr/IMG/NFL_Presentation_31_janvier_2011%281%29.pdf

RFF, 2009, Noeud Ferroviaire Lyonnais. Problématique et mise en perspective. Available on

<http://www.rff.fr/IMG/ofely-noeud-lyonnais.pdf>

RFF, 2009, Noeud Ferroviaire Lyonnais. Les coups partis et leurs apports. Available on

<http://www.rff.fr/IMG/ofely-amenagements.pdf>

SNCF, 2010, Offre de référence de la SNCF pour 2011 révisée, annexée au DRR.

Sterzenbach, R. (2003), Luftverkehr: betriebswirtschaftliches Lehr- und Handbuch, Oldenbourg Wissenschaftsverlag, Oldenbourg.

Stockholm Arlanda Airport (2010). Facts and figures.

Voka – Kamer van Koophandel Antwerpen-Waasland, *Luchthaven Antwerpen; bereikbaar, snel, efficiënt – Antwerp Airport; accessible, quick, efficient*, Antwerp, 54 p.

5.2 Websites

http://www.estacion-zaragoza.es	Estación Central Autobuses de Zaragoza
http://www.adif.es	Administrador de Infraestructuras Ferroviarias
http://www.consortiozaragoza.es/	Consortio de Transportes del Área de Zaragoza
http://www.atmlleida.cat/	Autoritat Territorial de la Mobilitat del Area de Lleida
http://www.zaragoza.es	Ayuntamiento de Zaragoza
http://www.paeria.es	Ayuntamiento de Lleida

http://www.renfe.es/	Renfe Operadora
http://www.fgc.cat/cat/index.asp	Ferrocarriles de la Generalidad de Cataluña
http://www.tuzsa.es	Tuzsa
http://www.autobusoslleida.com	Autobusos de Lleida S.A. (Grupo Moventis)
http://www.ctm-madrid.es/	Consorcio Regional de Transportes de Madrid
http://www.madrid.es	Ayuntamiento de Madrid
http://www.metromadrid.es/	Metro de Madrid
http://www.emtmadrid.es/	EMT
http://www.alsa.es	Alsa
http://www.movelia.es/	Continental Auto
http://www.plmautocares.com/	PLM Autocares
http://www.etasa.es/	Empresa Turística de Autobuses, SA (ETASA)
http://www.antwerp-airport.be/	Antwerp Airport
http://www.delijn.be/index.htm	De Lijn (bus company)
http://nl.mappy.com/	Mappy
http://www.b-rail.be/nat/N/	NMBS (rail company)
http://www.taxisantwerpen.be	Taxi's Antwerp
http://www.world-airport-codes.com	World Airport Codes
http://www.ana.pt/ucm/groups/algarve/documents/boletimtrafego/mkt_003715.pdf	
http://www.hahn-airport.de/	Frankfurt Hahn airport
GIL – Gare Intermodal de Lisboa (Gare do Oriente manager): <accessed on 20 June 2011>	
http://www.parqueexpo.pt/conteudo.aspx?lang=pt&id_object=699&name=Gare-Intermodal-de-Lisboa	
Vila Franca de Xira rail station: <accessed on 20 June 2011>	
http://www.cp.pt/cp/displayPage.do?vnextoid=47d6d3b5ab984010VgnVCM1000007b01a8c0RCRD&contentId=93f80195ea706010VgnVCM1000007b01a8c0RCRD	
BoaViagem (Bus short-distance operator in Vila Franca de Xira): <accessed on 20 June 2011>	
http://www.boa-viagem.pt/	

6 Annexes - Detailed Description of the Case Studies

6.1 Gothenburg Central Station, Sweden

6.1.1 Main features of the site

Gothenburg is Sweden's second largest city with a population of 515 129 inhabitants. Gothenburg and the Gothenburg region have a high population growth that puts high demand on communications' to and from the city. Gothenburg Central Station is the major national, as well as the regional, transport hub for passenger transportation in the south west of Sweden. Gothenburg Central Station has good connections to Sweden's capital Stockholm as well as to Denmark's and Norway's capitals' Copenhagen and Oslo. Gothenburg Central Station is located in the central area of the city of Gothenburg.

The map below (see Figure 2) displays the Gothenburg Central Station area. The red lines in the map show the pedestrian paths through the station area. The distance between Kruthusgatan (at the top of the map) and Drottningtorget in the map's foreground is about 600 meters.

Gothenburg Central Station consists of three buildings:

- The old but restored railway station, "Centralstationen" (Central Station, 1856-1857)
- The new meeting place, "Centralhuset" (Central House, 2003) and
- The quite new bus terminal, "Nils Ericsson Terminal".

There are three owners at the complex: Jernhusen (Central Station and Central House); Västtrafik (Nils Ericsson Terminal) and Trafikverket (train platform).

These three buildings together constitute a travel centre with shops, cafés, restaurants, offices and a hotel.

The newly built building, Centralhuset in the middle (see Figure 2 below), is integrating the Central Station with the Nils-Ericsson Terminal. There are a large number of entrances to the Central Station which simplifies transfer for the passengers. The Central Station is also well adjusted for different groups of passengers.

The railway station has 15 tracks where the commuter, regional, interurban and international rail services arrive and depart from.



Figure 6.1: Map displaying the station area

The bus terminal has 18 gates where Västtrafik's buses arrive and depart. Furthermore shuttle buses to the airports depart from the bus terminal as well as a couple of commercial bus services. Commercial transport operators want to use the gates for pick up and drop off passengers. In general, the commercial transport operators are referred to the bus stops on the outside of the bus terminal, due to congestion. The passengers can anyhow use the bus terminal to warm themselves in cold or rainy weather.

The local bus service and tram service are found at Drottningtorget/Burgrevegatan. Transferring between long distance rail and bus services to other rail and bus services can easily be done within the centre of the station area. When transferring to tram or local bus-service at Drottningtorget/Burgrevegatan a busy street has to be crossed. This can be time consuming as well as a security risk for different groups of passengers and at the same time work as a barrier.

There are several parking spaces within the station area; just outside the bus terminal meant for short term parking, in the parking garage under the bus terminal and between Kruthusgatan in the northern parts of the station area. Taxi services are found next to the railway station where only taxis with agreements from Jernhusen are allowed to provide taxi service.

Overall, there are a large number of stakeholders at Gothenburg Central Station working for maintaining the highest level of quality of services. Regardless of ticket class, the passengers can access the lounge which offers lunch, newspapers, magazines, coffee, tea, juice, clean toilets, fast Internet connection and a bar. In the conference area there are meeting rooms of various sizes and modern equipment available.

6.1.1.1 Identification of the site

There are four concepts that are important for the WP5: geographical coverage, transport mode, services per mode and interfaces & interconnections.

The case study of Gothenburg Central Station (see Table 1) covers:

1. Long-distance (for land >100 km) and short-distance (for land <100 km) transports.
2. Three different transport modes: rail, bus and car.
3. High capacity transport modes: rail and bus.
4. Low capacity transport modes: car.
5. Different transport services:
 - a. Rail services: international rail service, interurban rail service, tram service and commuter train service.
 - b. Bus services: international bus service, interurban bus service, urban bus service and shuttle service.
 - c. Car services: taxi, mobility service for passengers with disabilities, private car and rental car.

The case study of Gothenburg Central Station (see Table 1) also covers all three levels of interconnectivity which are addressed in the HERMES project:

- Interfaces between different modes: rail – road
- Interfaces between different type of service of the same mode: rail-rail, road-road
- Interfaces between high capacity and low capacity mode: bus and taxi etc.

GOTHENBURG CENTRAL STATION	High capacity					Low capacity
	Transport modes	Rail		Bus		Car
	Transport services	Rail services	Number of lines	Bus services	Number of lines	Car services
Geographical coverage	Long distance services >100 km	International rail service	3	International bus service	3	Taxi
		Interurban rail service	10	Interurban bus service	10	Mobility service for passengers with disabilities
	Short distance services <100 km	Tram service	1 (with stop at station)	Interurban bus service	14	
		Commuter train service	2	Urban bus service	9	Privat car
		Interurban rail service	3	Shuttle service	2	Rental car

Figure6.2: Identification of the site: Gothenburg Central Station Station

Gothenburg Central Station is an interchange of great importance with about 100 000 passengers per weekday, furthermore the travelling to and from the Central Station is increasing continuously. In addition congestion charges will soon be introduced in Gothenburg City, which will increase the pressure on the interchange even more.

From the Table 1 we can list the following lines per transport services:

- 13 lines for long-distance rail services are
- 6 lines for short-distance rail services
- 13 lines for long-distance bus services
- 25 lines for short-distance bus services

6.1.2 Method for data collection

6.1.2.1 Observations and collected material

6.1.2.1.1 Transport demand/Passenger flow

Statistical data has been collected from three main stakeholders at the Gothenburg Central Station: Västtrafik, Göteborgs Spårvägar and SJ.

Västtrafik (The Public Transport Authority) delivered statistical data from their passenger survey dealing with the total number departing passengers with commuter train as well as for bus traffic at Gothenburg Central Station during one day in November 2010. We also got an average data for total number of passengers to and from Gothenburg Central Station during one year (2010). Göteborgs Spårvägar (Gothenburg tramways) delivered data for tramway traffic to

and from Gothenburg Central Station (for 2010). SJ (the largest train operator in Sweden) delivered data for the total number of arriving and departing passengers to and from Gothenburg Central Station.

Our ambition was to get an overview of the total travelling to and from the Gothenburg Central Station. Contacts with a number of private operators who were supplying travel services at Gothenburg Central Station have been taken. Unfortunately, the private operators were not willing to give out this type of information due to their policies about company secrets.

6.1.2.1.2 Time data

Data about satisfaction with average service times (e.g. how long time it takes to walk between different functions at the central, to get different kind of services, to wait before departure with connecting transport mode) have been collected on-site by personell at Gothenburg Central Station according to time division as shown in the figure below (Figure 3).

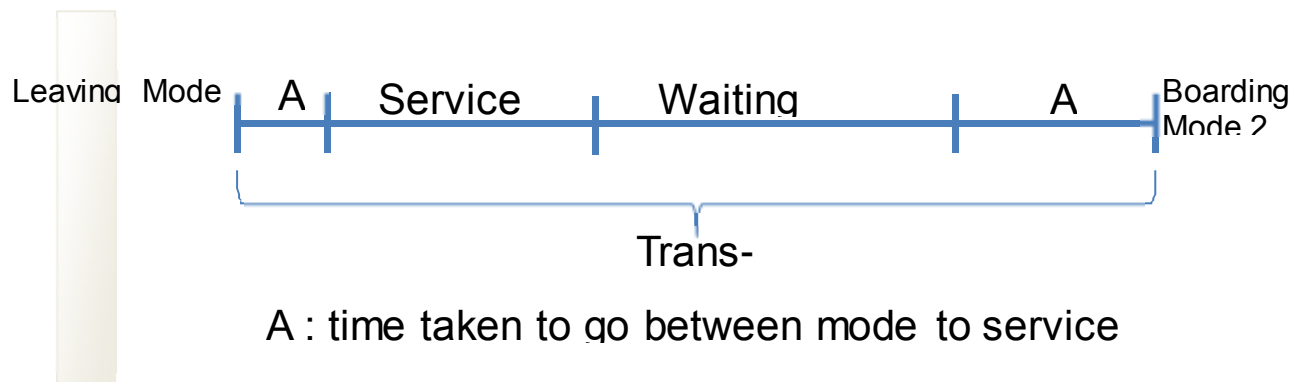


Figure 6.3: Time division according to guideline

Observations were made by counting people that were served in a given interval of time. The considered time interval was twenty minutes. Twenty minutes was chosen taking in to consideration the shortage of time at the site and the number of different means of providing the service. Total duration of observations was three hours.

In addition, time data regarding the passengers' average time at the station before departure as well as their satisfaction/dissatisfaction regarding the same factor has been extracted from the observations and the customer survey.

6.1.2.1.3 Space data

Space data have been collected on-site by personell by counting available facilities and information channels on Gothenburg Central Station. The facilities and information channels have also been investigated in order to find out the level of accessibility for different groups of passengers such as disabled people, parents with pram and passengers with heavy luggage.

In addition the passengers' satisfaction/dissatisfaction regarding factors about space has been extracted from observations and the customer survey.

6.1.2.1.4 Information, Ticketing and Check-in Services data

Data about the provided information at Gothenburg Central Station have been collected on-site in order to find out whether the numbers of signs are sufficient or not. The number of information signs has been collected by simply counting and these have also been investigated in order to determine the level of clarity and the accuracy mediated in the signs.

Data about ticketing have partly been collected by staff on-site through observations as well as by data about ticketing at the Västtrafik's website. The staff on-site did investigate the possibilities to buy tickets on-site from different transport operators by ticketing machines from staff and the time needed for this. Observations were made by counting the people that were served in a given interval of time. The considered time interval was twenty minutes. Total duration of observations was three hours.

Due to the fact that the interchange has no flight services there is no check-in service.

6.1.2.2 Customer survey

The customer survey was carried out between 11th April and 19th April 2011. In accordance with the HERMES customer survey template an questionnaire was developed for Gothenburg Central Station. The questionnaire contained 24 questions.

The distribution of the questionnaires was conducted on-site by two staff members with experience of making questionnaire surveys. The staff spent approximately 40 hours at Gothenburg Central Station, from 08:00 – 19:00 inclusive breaks. A total of 603 questionnaire answers were gathered. The answers were collected at the bus terminal (Nils Ericsson Terminal) and the Central House (Centralhuset).

6.1.2.3 Stakeholder interviews

According to WP3 and WP4 there are four stakeholder groups: decision makers, terminal managers, transport operators and users' associations. The stakeholder survey at Gothenburg Central Station was conducted with three of the four stakeholder groups: decision makers, terminal managers and transport operators. There is no users' association as such in Gothenburg.

The persons who have been interviewed were as following:

- Person 1 - Infrastructure manager ("Västtrafik", decision maker, publicly owned company)
- Person 2 - Station manager ("Jernhusen" , terminal manager, publicly owned company)
- Person 3 – CEO ("Swebus" , (bus) transport operator, private company)
- Person 4 – CEO ("Göteborgs Spårvägar", (tram and bus) transport operator, publicly owned company)
- Person 5 – Business manager ("SJ" , (train) transport operator, state-owned company)

The stakeholder interviews were telephone-interviews of approximately 30 minutes – 1 hour to receive a detailed and comprehensive insight into the current situation at Gothenburg Central Station. Before the interviews a comprehensive description was made in order to gain information and understanding about Gothenburg Central. The interviews could therefore directly focus on the following issues:

- Activities at Gothenburg Central Station
- Business-model
- Interchange- Coordination between different transport modes, co operations, ticketing, information system, delays.

6.1.3 Stakeholders at the site

Stakeholders at the Gothenburg Central Station have been classified into the following stakeholder categories (see Figure 4):

1. Decision maker

2. Terminal managers
3. State-owned Transport Operators
4. Private-owned Transport Operators
5. Service Providers

6.1.3.1 Decision Maker

Trafikverket (The Swedish National Transport Administration) is responsible for all modes of traffic: transport on roads and railways, at sea and in the air. This responsibility includes maintaining, operating and developing roads and railroad as well as to coordinate urban, regional and inter-regional railway traffic. Trafikverket is responsible for keeping roads free from snow during winter. Trafikverket is furthermore responsible for delivering traffic information to companies as well to passengers.

Gothenburg City is an important stakeholder because of their responsibility of planning the city and their land ownership around the Central Station. The office manages the City's infrastructure (road and tram infrastructure). Since 1999 all public transport in the region of Västra Götaland is coordinated under the Public Transport Authority- Västtrafik.

Västtrafik AB is responsible for all procurement of rail and bus services to the Nils Ericsson Terminal. The company carries out decisions made by public decision makers (like Trafikverket and Gothenburg City). Västtrafik is also the owner of the Nils Ericsson Terminal which is one of the three building together forming Gothenburg Central Station. Västtrafik has also responsibility for maintenance of bus stops. It is Sweden's second largest public transport authority. 50% of the company is owned by the Västra Götaland county and 50% by the 49 municipalities of Västra Götaland. Västtrafik has the responsibility to co-ordinates all public transport services in the whole Västra Götaland County and give access to 1,600 vehicles in the form of buses, trains, trams, taxis and ferries.

6.1.3.2 Terminal managers

Jernhusen was formed in connection with the incorporation of the Swedish State Railways at the turn of 2000/2001. Jernhusen owns, manages and develops a property portfolio of stations, offices, maintenance depots and freight terminals along the Swedish railway. Most are located in and around major cities in Sweden. Jernhusen is owned by the Swedish state. Their mission from the central government is to help stations, freight terminals and maintenance-centres to be developed and made available to service operators, passengers and other users on competitively neutral terms. They shall also ensure that passengers' needs for security, safety and service are met. This means that stations have waiting rooms, storage areas, toilets etc.

Stakeholder group Stakeholder	Decision Maker	Terminal Managers	State-owned Transport Operators	Private-owned Transport Operators	Service Providers
 TRAFIKVERKET	x				
 GÖTEBORG CITY	x				
 JERNHUSEN		x			
 VÄSTTRAFIK	x				
 DSBFIRST VÄST				x	
Arriva Sverige AB			x (Germany)		
 GÖTEBORGS SPÅRVÄGAR			x		
 SJ AB			x		
 Swebus Express AB				x	
GoByBus				x	
Bus4You				x	
 HERTZ				x	
Din bil Sverige				x	
Europcar				x	
 TAXI GÖTEBORG				x	
33 different service providers					x

Figure 6.4: Stakeholders at Gothenburg Central Station Station

6.1.3.3 *Transport operators (publicly owned)*

There are three major transport operators at Gothenburg Central Station: Göteborgs Spårvägar, SJ AB and Arriva Sverige AB (see Figure 4 above).

Göteborgs Spårvägar (owned by Gothenburg city) has the role to conduct passenger traffic in competition with other companies. Göteborgs spårvägar runs both bus and tram traffic and provides following services (see Figure 5 below):

- Short-distance: tram services
- Short-distance: interurban bus services
- Short-distance: urban bus services

Göteborgs Spårvägar is contracted by Västtrafik.

SJ AB is owned by the Swedish government and runs under commercial terms and conditions. SJ are the largest train operator in Sweden and provides following the rail services from Gothenburg Central (see Figure 5 below):

- Long-distance: international rail services
- Long-distance: interurban rail services
- Short-distance: interurban rail services

Arriva Sverige AB is owned by the German government and runs under commercial terms and conditions. Arriva Sverige AB provides (at Gothenburg Station) long-distance interurban rail services (see Figure 5 below) and is contracted by Västtrafik.

6.1.3.4 *Transport operators (private-owned)*

Beyond the major state-owned transport operators there are ten privately owned bus companies who are contractors to Västtrafik. Four major bus companies are here presented.

Swebus Express AB runs bus traffic and provides the following services (see Figure 5 below):

- Long-distance - international bus service
- Long-distance - interurban bus service
- Short-distance - interurban bus services
- Short-distance - urban bus services
- Short-distance - shuttle service

Flygbussarna Airport Coaches provides airport bus services and shuttle service (short-distance).

Both **GoByBus** and **Bus4You** provide long-distance bus services: international and interurban services (see Figure 5 below).

Besides bus companies there are three rental car companies (Hertz, Din bil Sverige and Europcar). They provide both long and short-distance car services and are contractors to Jernhusen. Taxi Göteborg is the largest taxi company and run both long and short-distance car services. Taxi Göteborg is contractor to Jernhusen.

Transport services Transport operator	Rail services		Bus services		Car services	
	long-distance	short-distance	long-distance	short-distance	long-distance	short-distance
OSBFIRST VÄST	International rail service	Interurban rail service	-	-	-	-
	Interurban rail service	Commuter train service				
Arriva Sverige AB	Interurban rail service	-	-	-	-	-
GÖTEBORGS SPÅRVÄGAR	-	Tram service	-	Interurban bus service	-	-
				Urban bus service		
SJ AB	International rail service	Interurban rail service	-	-	-	-
	Interurban rail service					
Swebus Express AB	-	-	International bus service	Interurban bus service	-	-
			Interurban bus service	Urban bus service		
Flygbussarna	-	-	-	Shuttle service	-	-
GoByBus	-	-	International bus service	-	-	-
			Interurban bus service			
Bus4You	-	-	International bus service	-	-	-
			Interurban bus service			

Figure 6.5: Major transport operators and their services at Gothenburg Central Station

6.1.3.5 Service Providers

There are 33 different service providers located at Gothenburg Central Station. There are a lot of shops, cafés, restaurants, offices and a hotel⁴.

⁴ Espresso bar – café, Burger King - restaurant, Jernhusen Station Lounge, SJ Station Lounge, Press-bureau, Press-stop, Forex Bank, Lindex - shop, Le Croissant – restaurant, Väskaffären – shop, SUB way – restaurant, 7 eleven – shop, Praline – shop, Solresor – travel agency, Apotek – shop, The Body Shop, Life – shop, Patcys blommor – shop, Sun-sushi – restaurant, Sidewalk-express internet café, Blue eat and drink - restaurant, Forex bank, CD-centralen - shop, Pocket-shop, etc.

6.1.3.6 *The stakeholders from an Agents perspective*

6.1.3.6.1 Objectives and Goals

According to the stakeholder interviews all stakeholders have as objectives to:

1. satisfy their customers
2. increase the number of passengers/travelers
3. increase the number of sold tickets

According to the customer survey the passengers have as objective to travel with:

4. high comfort of transport modes
5. reasonable ticket-prices
6. short total travelling time.

6.1.3.6.2 Strategies

All passengers can, as citizens, influence transport decision makers to improve Gothenburg Central Station. Passengers need integrated information from different transport operators in order to plan their trips. This information can be available by using different channels, for example websites, mobile applications and so on.

Decision makers' plan is to fully de-regulate Swedish passenger transport and thus achieve their objectives and goals. To avoid the risk of getting a situation with less co-ordinated information and confusion among travellers they need to integrate information from different transport operators.

To increase customer satisfaction the terminal manager need to offer high level of comfort at the Station. The terminal manager has contracts with different subcontractors who are delivering different services.

Transport operators also need to offer comfort to the customers. There are also subcontractors who are delivering different services. They can offer information about departures/arrivals, tickets at the website. They can do this information available on the Station.

6.1.3.7 *Interactions between agents*

The table below describes the nature of the interactions between some agents at Gothenburg Central Station.

Agents	TRAFIKVERKET	Göteborgs Stad GOTHENBURG CITY	VÄSTTRAFIK	JERNHUSEN	OSBFIRST VÄST	SJ	Göteborgs Spårvägar
TRAFIKVERKET	Decision Maker	Implements Trafikverket's decisions and laws in region	Carry out decisions about rail and bus services	Carry out decisions about citizen's security, safety and service	Deliver traffic information	Deliver traffic information	Deliver traffic information
Göteborgs Stad GOTHENBURG CITY	Principal to the Gothenburg City	Decision Maker	Carry out decisions about rail and bus services	Carry out decisions about citizen's security, safety and service	Services and taxes	Services and taxes	Services incomes
VÄSTTRAFIK	Carry out decisions about rail and bus services	Carry out decisions about rail and bus services	Decision Maker	Cooperate and collaborate for passenger's and own best	Services and Incomes	Services	Services incomes
JERNHUSEN	Carry out decisions about citizen's security, safety and service	Carry out decisions about citizen's security, safety and service	Cooperate and collaborate for passenger's and own best	Terminal Manager	Services and incomes	Incomes	Incomes
OSBFIRST VÄST	Deliver traffic information and infrastructure	Deliver information and infrastructure	Contract	Contract and services	State-owned Transport Operator	Competitor	Competit
SJ	Deliver traffic information and infrastructure	Deliver information and infrastructure	Contract	Contract and services	Competitor	State-owned Transport Operator	-
Göteborgs Spårvägar	Deliver traffic information and infrastructure	Own company, deliver information and infrastructure	Owner; agreement	Contract and services	Competitor	-	State-own Transport Operator
Swebus Swebus Express AB	Deliver traffic information and infrastructure	Deliver information and infrastructure	Contract	Services	Competitor	Competitor	Competit
Hertz	Deliver traffic information and infrastructure	Deliver information and infrastructure	Some services	Owner of land, services	Competitor	Partner	Competit
Taxi Göteborg	Deliver traffic information and infrastructure	Deliver information and infrastructure	Some services	Owner of land, services	Competitor	Partner	Competit

Figure 6.6: Interactions between some agents at Gothenburg Central Station

6.1.3.8 Graphical representation

The figure below (Figure 5) presents the agents at Gothenburg Central Station and their main interactions.

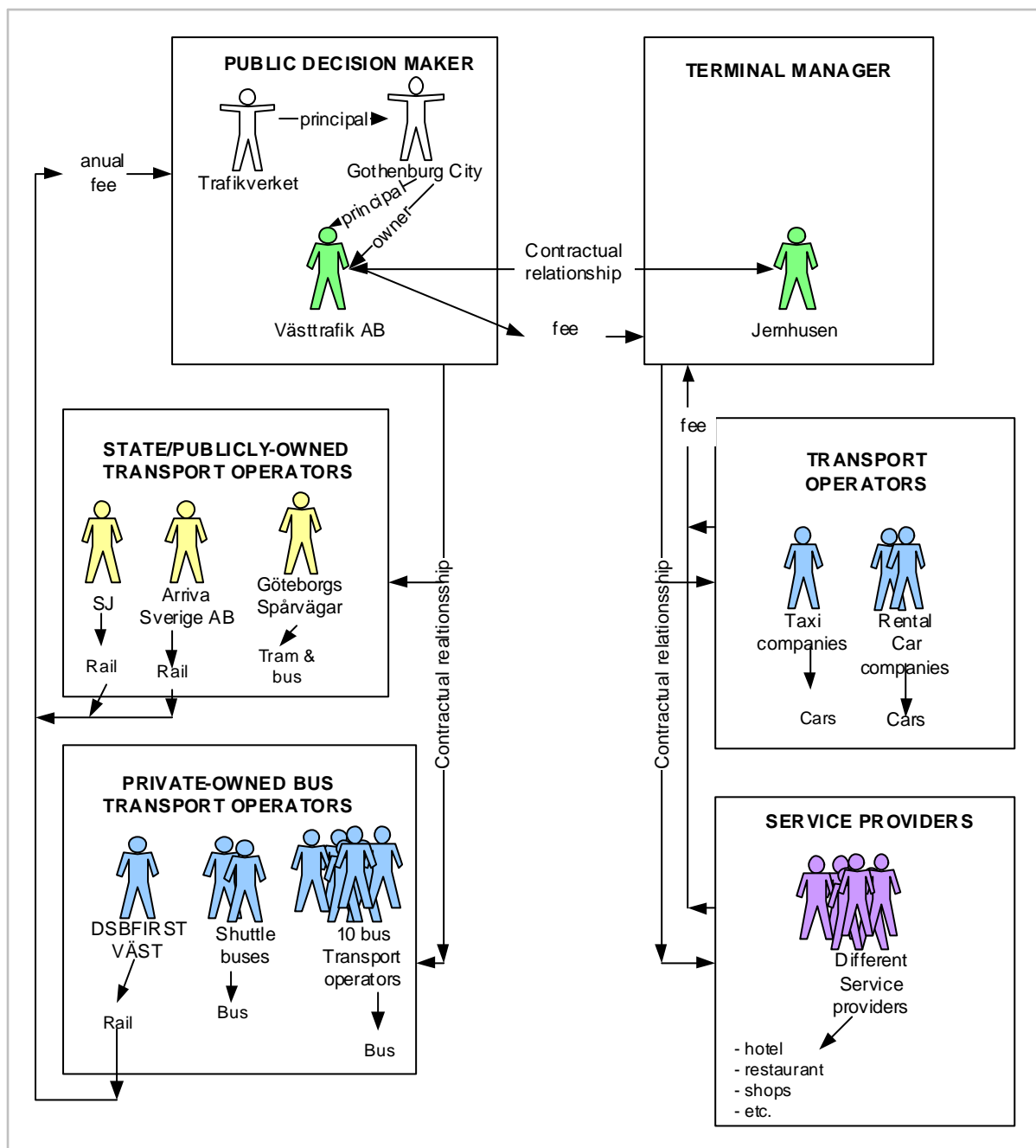


Figure 6.7: Agents and their interactions

6.1.4 Current short-long interconnectivity problems/opportunities

Results from WP3 and WP4 showed (see Figures 7 and 8) that regulations about information services as well as regulations about safety and security can be improved in Sweden. Satisfaction with these parameters was lower than in other European countries, for example in Eastern and Southern countries.

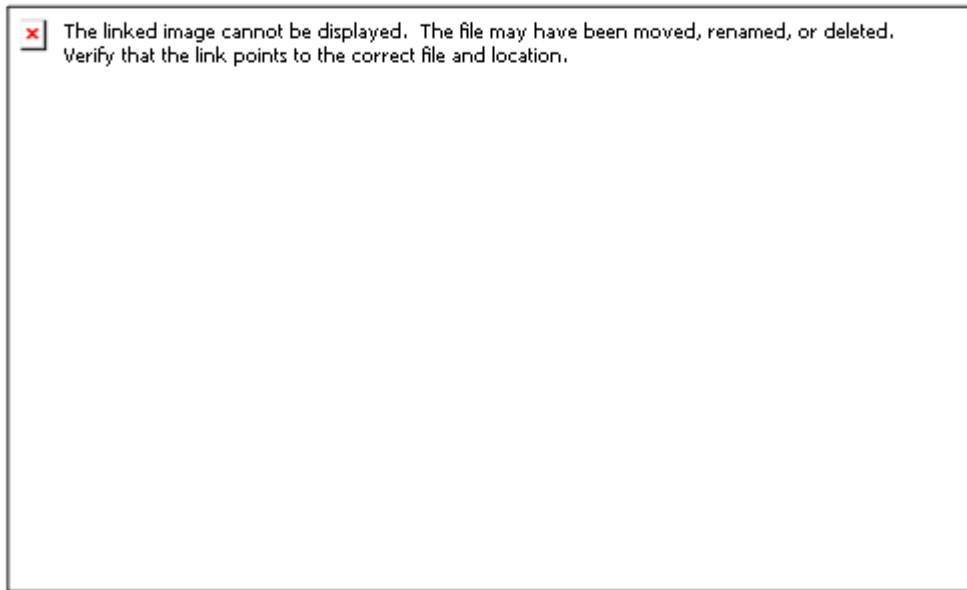


Figure 6.8 Regulatory framework for information services: G3 opinion, per typology of country

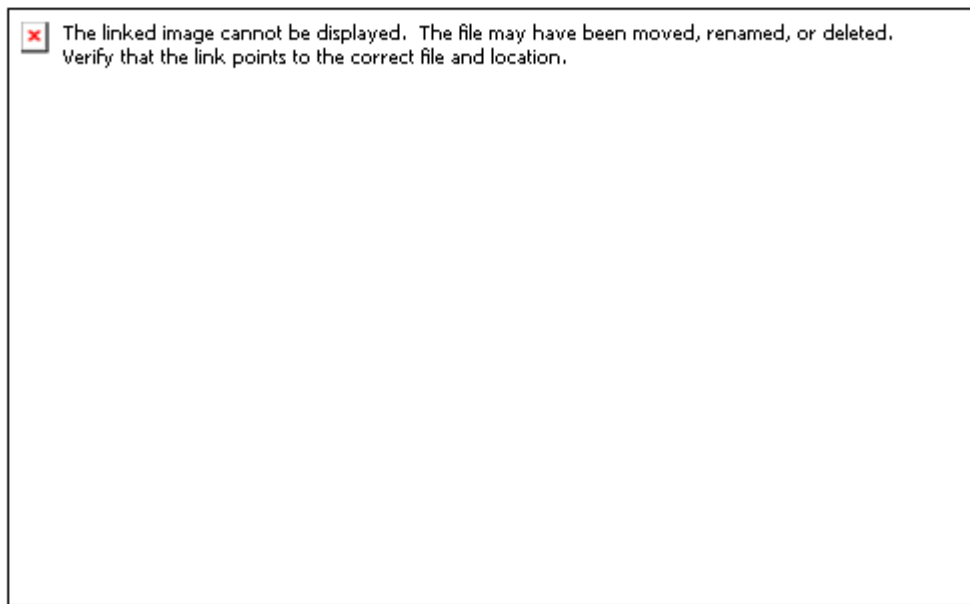


Figure 6.9 Regulatory framework for safety and security: G3 opinion, per typology of country

Furthermore, the results from WP3 and WP4 (see Figure 7) also highlighted an observation that “The level of service is formally assessed/monitored in Eastern and Southern countries more than in the Nordic and Central ones: this is unexpected, because the latter are traditionally more experienced regards to regulation aspects within the transport sector”.



Figure 6.10 Common formal requirements for level of service, per typology of country

6.1.5 Current value proposition

During the past winter (November-March 2010/2011) the number of disturbance hours for passengers in the Swedish train traffic were 4,1 million hours, which corresponds to a cost of 2,6 billion SEK. This is an increase with 8 % compared with the last winter. The lack in correct information in the stations and on the trains has been bad and the travellers' satisfaction has been very low during this period.

This was also highlighted in the WP3/4 survey where the Swedish respondents were not content with the quality/service. The reasons for this could be the winter problems together with the fact that Swedes tend to be self-critical.

January 1st 2012 the Swedish passenger transport will be fully de-regulated. This implicates that more stakeholders and operators will be present at Gothenburg Central Station. The risk of getting a situation with less co-ordinated information and confusion among travellers is high.

Value proposition: Maintain/ increase the information quality and standard at the station in order to maintain/ increase the customer satisfaction.

6.1.6 Description of current business model

The description of the current business model is gathered by reading stakeholders' annual reports and collecting information available at stakeholder's website. Current business model has thereafter been complemented and confirmed by stakeholder interviews.

Current Business Model for Gothenburg Central Station is described according to Osterwalder (2004). There are nine building blocks: Customer Segments (CS), Value Propositions (VP), Channels (CH), Customer Relationships (CR), Revenue Streams (R\$), Key Resources (KR), Key Activities (KA), Key Partnerships (KP) and Cost Structure (C\$).

6.1.6.1 Customer Segments (CS)

Each day about 100 928 trips is done by passengers who are crossing Gothenburg Central Station(see Table 3 below).

Data	Number of trips
Västtrafik (Nils Ericsson Terminal)	45 000
SJ	13 600
Göteborgs Spårvägar	42 328
Total:	100 928

Figure 6.11: Number of trips per day at Gothenburg Central Station Station

This number is uncertain. None of the asked stakeholders' had the opportunity to deliver passenger statistics in the desired form. The private stakeholders were not willing to share any statistics due to their policy regarding company secrets.

According to Västtrafik about 57 percent of the passengers are women and 43 percent are men. Our customer survey (April 2011) showed that women were represented with 65,5 percent and men with 34,5 percent.

Our customer survey showed furthermore that especially younger passengers are the major customers (60%) of the Gothenburg Central. See Table 4 for a detailed age distribution:

Age group	Distribution (Percent)
15 - 20	31,5 %
21 - 35	28,7 %
36 - 55	19,1 %
56 - 64	10,5 %

Figure 6.12: Age distribution of Gothenburg Central Station (Customer survey, 2011)

There are no statistics about the percentage of passenger with disabilities travelling to and from Gothenburg Central Station. However, in the whole county where Gothenburg is located about 17 % of the population has disabilities which is not depended on their age but this doesn't say much about whether they choose to travel with public transports or not.

According to Västtrafik these are the three most common destinations: Lysekil, Strömstad and Tranemo. The customer survey showed that most common short-distance destinations were within Gothenburg and Borås. The most common long-distance rail destinations in the customer survey where: Stockholm, Karlstad, Trollhättan, Skövde, Växjö and Lund.

The customer survey showed that the travel purpose had in more than half of the cases to do with something private such as: vacation, leisure, visiting family and friends. About 22 % had a business purpose and 11 % were travelling to or from school. Furthermore, about 5 % stated other purpose with the current trip or left/picked up someone at the station.

Only SJ (the largest Swedish train transport operator) offers customers to choose between first and second class. Passengers who travel in first class gets more comfortable seats, free newspaper and access to internet onboard the train. Furthermore, first class travellers are allowed to use SJs lounge at Gothenburg Central Station for free. With exception from SJs customers all passengers travel in the same class.

6.1.6.2 Value Proposition (VP)

The following questions are answered in detail in section 2.4:

- What kind of transport services does the company offer?
- What are the different services provided by the company?

In Sweden the possibility to make own combination of trips between origin and destination is very high. Västtrafik's travel card enables the opportunity to travel with the same travel card within the company's different transport modes independent what transport service being used.

The different ticket-systems that the different operators have can be an obstacle for travellers. Cashless travelling in public transport is more and more common and that can also be an obstacle for travellers (especially for those who use it seldom). It is however only SJ (train operator) who provides different travel classes.

Västtrafik is working continuously for improving the accessibility for people with reduced mobility and applies the principle that people with reduced mobility has the same wish and need to travel as anybody else. This group is allowed to travel with Västtrafik; however, Västtrafik cannot guarantee that the transport mode has room for a wheelchair or a rollator on board. Furthermore, Västtrafik requires that the passenger has an escort or can help himself, in particular in the city traffic due to the harsh traffic in Gothenburg city.

Trafikverket and Jernhusen offer services on-site at Gothenburg Central Station for people with reduced mobility or other disabilities in order to make it easier for them to travel alone by train. This service includes help with trans-boarding at arrival to Gothenburg Central Station as well as at transfer.

Gothenburg Central Station has many transport services as well as other functions and a good overall passenger approach. The range of different combinations between transport services makes it easy to travel to and from the Central Station. Shuttle services from the central station to the airports and the port gives additionally opportunities to travel further.

Västtrafik as well as the large train operator SJ has in general a good reliability and punctuality. This together makes Gothenburg to a good central station with good transport services.

However there has been some problems which has resulted in a large number of delays and a decreasing reliability. The last two winters have been major challenges for the transport operators to deliver promised services. This together with bad systems for delivering information about disturbances and delays in the time schedules has contributed to the decreasing reliability. Another example is that Västtrafik during 2010 had several extended problems with delivering service, a number of procured transport operators had problems to deliver promised service and some buses with technical problems were in operation despite dangerous shortcomings. Also SJ had during 2010 a demanding year due to the harsh winter, although, even during the summer period a large number of delays occurred due to reduced speed for the X2000 trains. SJ had an overall punctuality at 85 % during 2010 but still a low customer satisfaction. The reliability for SJ has decreased during the later years due to delays.

6.1.6.3 Channels (CH)

Information is distributed through different forms of media. The main channel regarding information about Gothenburg Central Station and transport operators is provided by Internet.

There is one specific website for Gothenburg Central Station, www.stationsinfo.se, owned and operated by Samtrafik. Samtrafik is owned by 50 companies and businesses and they are all part of the Resplus cooperation. Samtrafik's vision is that public transport will be seen as simple, reliable, convenient and would like to become the number one choice for every journey. The company makes public transport competitive through effective partnerships with public transport carriers.

The website for Gothenburg Central Station displays all physical functions at the station by detailed maps with symbols for different functions including detailed information for people with reduced mobility or other disabilities which may have impact on their travel. Information about accessibility at the station can be found on the website, for instance information about thresholds and self-opening/manual doors can be found. This website provides information about where the different transport modes stop.

Regarding pre-information for example timetables and prices are in general found at the Västtrafik's and other responsible transport operators own websites. For most of the transport operators who have any activity at the central station websites are the most relevant channels.

Västtrafik provides a "Customer Center" where passengers can get information about traffic changes, stops, time-tables, prices etc. Passenger can get in contact with "Customer Center" by telephone, e-mail or regular letter. Customer Center receives input and complaints from passengers.

In addition Västtrafik conducted a big campaign where they challenged car drivers to park their car in favour to use public transports. This campaign was exposed in newspapers, by posters on bus stops and at information boards throughout the whole region.

According to our observations the real-time information about arrivals, departures and in case of disturbances are found at displays, placed at four places at the Central Station. Information about arriving and departing train is declared by speakers at the station. According to interviews with stakeholders the information when disturbances occur works quite well.

The need for different stakeholders to communicate with each other is, when it comes to travelers from long to short distance modes, not crucial though there is such a great offer of departures for short-way modes. Between different modes or operators for long to long

transport modes problems can occur and improvements can be made to handle the disturbances.

At Gothenburg Central Station a new possibility to spread information has been introduced by Jernhusen combining advertisement and real time information. The product is formed as advertisement signs which in case of disturbance instead are showing important travel information.

There is no common ticket-shop today where the customers can buy tickets from different operators due to contracts that cover an area at the station instead of having agreements of shared solutions for selling tickets and to give information to travelers.

Tickets can be bought from different transport operators in several different places depending on which mode you are about to travel with. At the station there are different sales places for tickets representing the different companies. Tickets can also be bought by travel agencies and online and are distributed to the customers in several different ways. Västtrafik is also offering a sms-service where customers can get their tickets directly to their cell-phone by sending a sms to Västtrafik. Tickets can also be purchased by credit card on-board.

Passengers are in general reimbursed in case of delays or failure of delivering promises service.

According to the stakeholder interviews there are improvements to be done for information signs and information in general.

6.1.6.4 *Customer Relationships (CR)*

There are several information desks at Gothenburg Central Station where different transport operators:

- sell tickets
- give a detailed face-to-face information
- help passengers with their issues.

It's also possible get in touch with responsible transport operators' customer service via phone or mail.

Both employees and ticket machines are used for selling tickets.

There are possibilities to buy either one-way tickets or buy highly discounted travel cards valid for instance for 30 or 90 days. Västtrafik is offering a large number of different season cards which can be used advantageously by passengers who are travelling regularly. There are different season cards for travelling within Gothenburg as well as for travelling to surrounding municipalities.

The private transport operators have similar customer offers as the Västtrafik. However, one difference is that these stakeholders often have different prices depending on when and how your ticket is booked. For instance some stakeholders prefer to sell tickets on the web and are therefore offering these tickets for a lower price than buying them at the station or on-board the transport mode.

6.1.6.5 Revenue Streams (R\$)

Västtrafik's revenue sources are: self-financing, 54%, and the rest, 46% are financed by the region, municipalities and government. Self-financing revenues are: ticket sale, leasing-, advertizing-, rental- and contracted traffic revenues.

Västtrafik sells different ticket-cards and these cards can be loaded with various travel opportunities:

- Period card– this is the card for those who travel regularly and includes many trips.
- Value card – this is the card for those who do not travel every day and a traveler pays for each trip.
- Single or three-day card – the traveler choose the number of trips she wants for one or three days.
- School card – is valid for travel with Västtrafik in the area and the times indicated on the front of the card. In some cases, the card is valid on SJ's train and Swebus' buses.
- Senior card – a few municipalities in Västra Götaland offers its older residents free travel.

Västtrafik is also selling one-way tickets and there is a ticketing scheme (see table5).

Area	Adult	Student	Adult Night	Student Night
Within municipality	32 SEK	24 SEK	53 SEK	45 SEK
Urban	21 SEK	16 SEK	42 SEK	37 SEK
Within Gotheburg	21 SEK	24 SEK	53 SEK	45 SEK

Figure 6.13: Ticketing scheme, one-way tickets (Västtrafik's website, April 2011)

The company has a revenue management system.

Jernhusen's main revenue resource are tenants who rent space for offices, shops or restaurants. The largest customers are Lindex, SJ, Press Office, 7-Eleven and Scandic Hotels. The rent for shops and restaurants is partly based on shop's/restaurant's turn over which means that travelers are very important as customers for Jernhusen. Another important customer group are transport operators who require facilities and services. Jernhusen and Västtrafik cooperate in some issues (for example cleaning, security services) but Västtrafik is paying some amount per year as a fee for Jernhusen's services. Jernhusen aslo has a revenue management system.

6.1.6.6 *Key Resources (KR)*

Västtrafik owns the building Nils Ericsson Terminal, bus-terminals, trams, trains and busses. Västtrafik has the following staff: management, administration and drivers. Västtrafik has contracts with security company, cleaning companies and companies for staff recruitment.

Jernhusen AB owns the buildings Central Station and Central House (see Figure 3), slots for private parking and taxi. Jernhusen has the following staff: management and administration. They have contracts with security company, cleaning companies and companies for staff recruitment.

6.1.6.7 *Key Activities (KA)*

At the Gothenburg Central Station the major activity is to supply passengers with promised transport services. Västtrafik plans and coordinates the public transport and procure operator companies (both publicly owned and private-owned companies). Both short and long distance services are provided at Gothenburg Central Station.

There are other activities at the interchange and some of these activities are complementary to the transport services such as cafés, conference facilities and restaurants which fulfill passengers' needs.

6.1.6.8 *Key Partnerships (KP)*

There is a whole network of actors linked to Gothenburg Central Station. For instance Västtrafik doesn't own or provide any transport services by themselves instead are the services procured and produced by other transport companies (see Figure 9).

Jernhusen procure and provide services by having contracts with other companies, for example Taxi and Rental companies. These companies need to fulfill some requirements in order to get permission to provide taxi and rental services outside the Central Station. Jernhusen have contracts with other service providers, for example some shops (see Figure 9).

There is a hotel located at Gothenburg Central Station above the waiting hall. This hotel is mainly intended to be a business hotel for guests arriving with train to the Central Station.

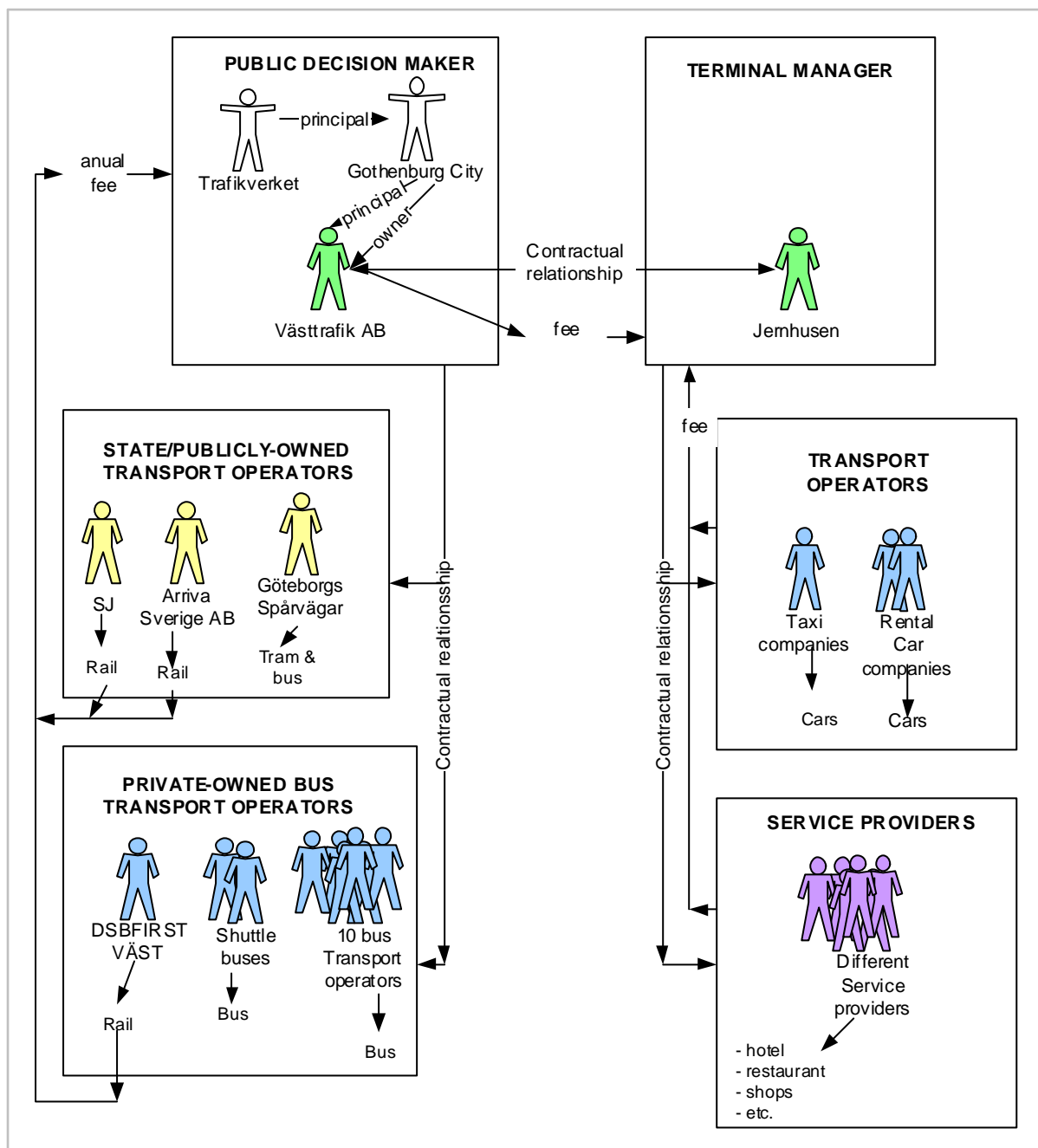


Figure 6.14: Gothenburg Central Station and main relationships between stakeholders

6.1.6.9 Cost Structure (C\$)

For Västtrafik, in order to get more people to travel with public transports, prices need to be affordable for customers in the same time as the services should be to a rather high extent self-funded. The companies need to create both a higher value (for example, in form of comfortable buses, express lines and so on) as well as offer affordable tickets in order to attract new customers and keep the present ones.

6.1.7 Current level of quality of services and customer satisfaction

6.1.7.1 Description general information about the passenger

Detailed information on general statistics about passengers (gender, age, travel purpose) has already been given in previous chapter and is not repeated here.

According to Figure 11 more than a third of the passengers arrived to Gothenburg Central Station by train (36,2 percent), 20 percent by tram and 19 percent arrived by local bus. Only two percent arrived to the station by taxi.

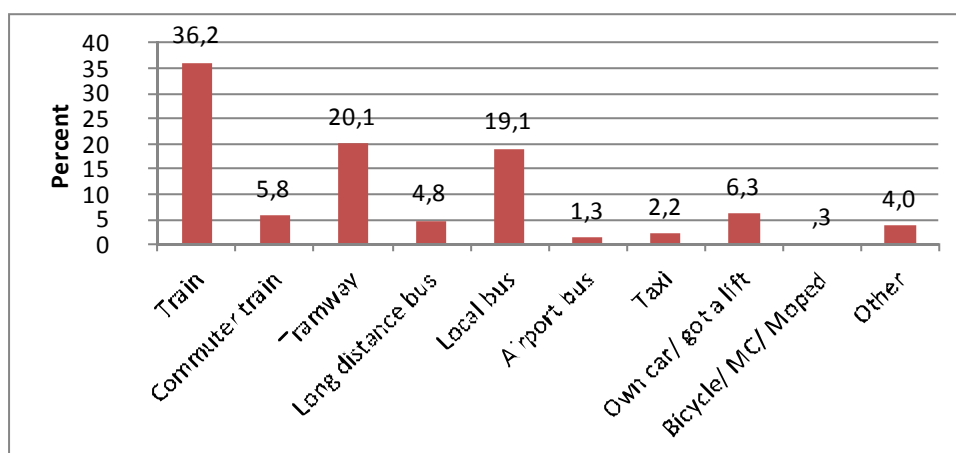


Figure 6.15: Last transport mode to Gothenburg Central Station (N=603)

Distance (in kilometers) from origin to the station can be summarized as follows: 46 percent of the passengers had a distance between 0-10 km and 52 percent of the passengers had a longer distance, between 10-700 km. It was only 2,8 percent of the passenger who had a distance more than 700 km (see Figure 12).

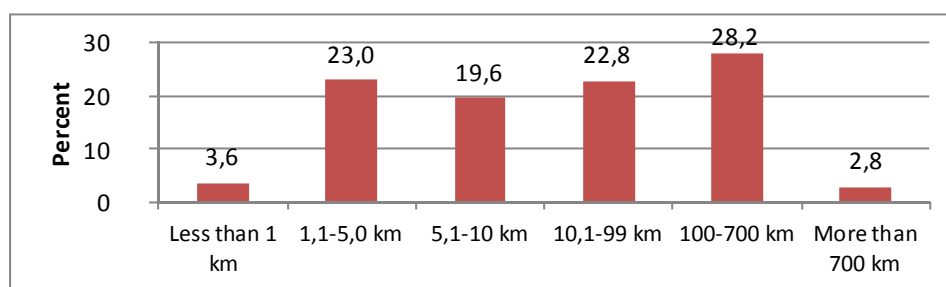


Figure 6.16: Distance from origin in kilometres to the Gothenburg Central Station.

Distance (in time) from origin to the Gothenburg Central Station can be summarized as follows:

- 52,4 percent - between 10 minutes and 1 hour
- 34,6 percent - between 1 and 4 hours and
- 7 percent - more than 4 hours.

A large percentage of the passengers intended to leave Gothenburg Central Station with train; almost 71 percent (see Figure 13). Almost 8 percent planned to continue their trip by local bus

and 7 percent of the passengers planned to travel further on by tram. Only 0,2 percent intended to travel further on by taxi.

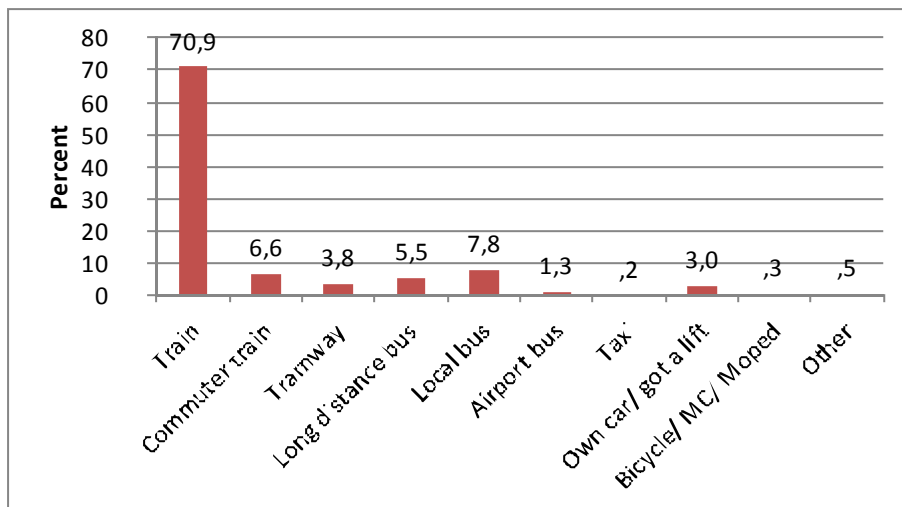


Figure 6.17: First transport mode when departing from Gothenburg Central Station (N=602)

Almost half of the passengers had a distance between 100-700 kilometers from Gothenburg Central Station and their final destination (see Figure 14). 24 percent of the passengers would travel between 10,1-99 kilometers and 11 percent more than 700 kilometers.

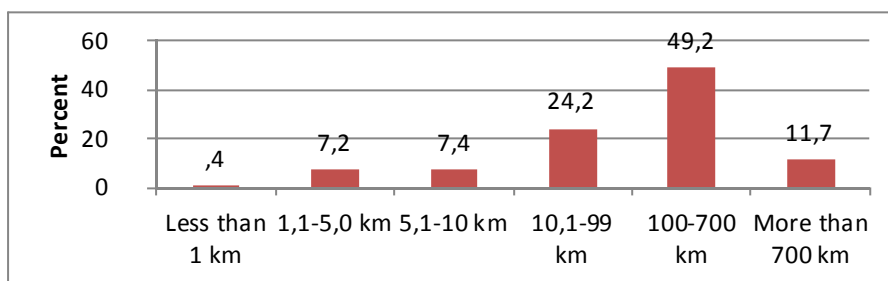


Figure 6.18: Distance from Gothenburg Central Station to final destination (N=472)

Distance (in time) from Gothenburg Central Station to final destination can be summarized as follows:

- 26,8 percent - between 10 minutes and 1 hour
- 55,4 percent - between 1 and 4 hours and
- 17,7 percent - more than 4 hours.

Above mentioned results and the results from previous chapter shows that Gothenburg Central Station is an important interface between short and long distance. Almost 86 percent of passengers used train, tram, local bus and commuter train as last transport mode to Gothenburg Central Station. Almost 71 percent intended to travel further on by train. This indicates that the station is an important interface between different types of services of same mode (rail).

6.1.7.2 Travel demand/Passenger flow

Detailed information on general statistics about passenger flow has already been given in previous chapter and is not repeated here.

The passengers were overall very satisfied or quite satisfied with the travel supply (see Figure 15). Passengers were very and quite satisfied with: coordinated timetables (66,6 percent), possible travel connections (65,7 percent), possibility to combine transport modes (63,3 percent) and use of waiting time (48,5 percent). Very few of the passengers are dissatisfied. However, 4 percent of the passengers were dissatisfied with the opportunity to make use of their waiting time at Gothenburg central.

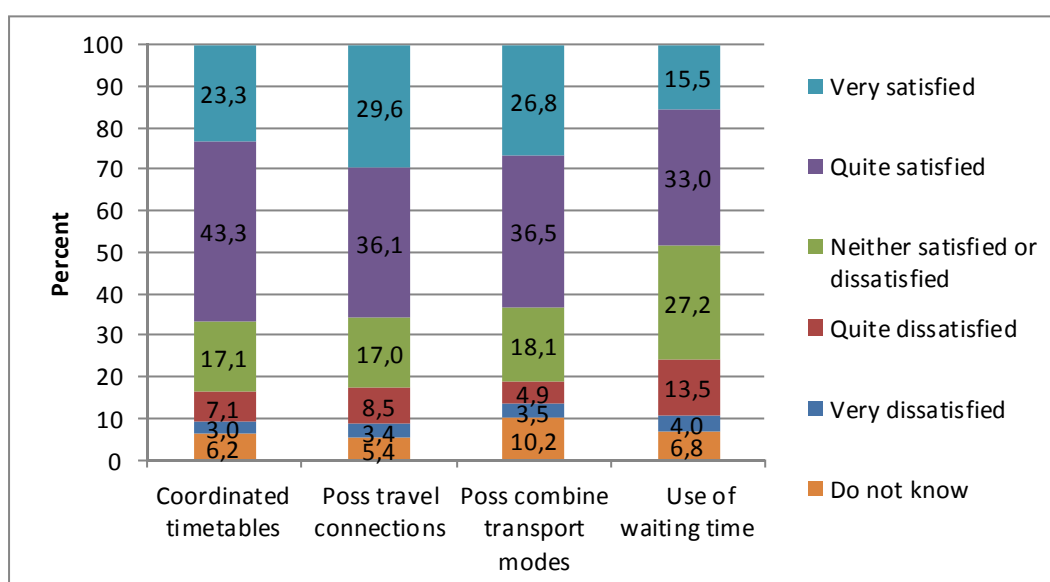


Figure 6.19: Level of satisfaction with travel supply (Customer Survey, part 2a, questions 10-11)

Figure 16 shows the passengers most critical factors considering their choice of transport mode without order.

Over 60 percent of the passengers stated that the comfort is the most important factor when choosing transport mode. The second most important factor when choosing transport mode is the ticket price (over 55 percent). The third most important factor is the total travelling time (almost 50 percent).

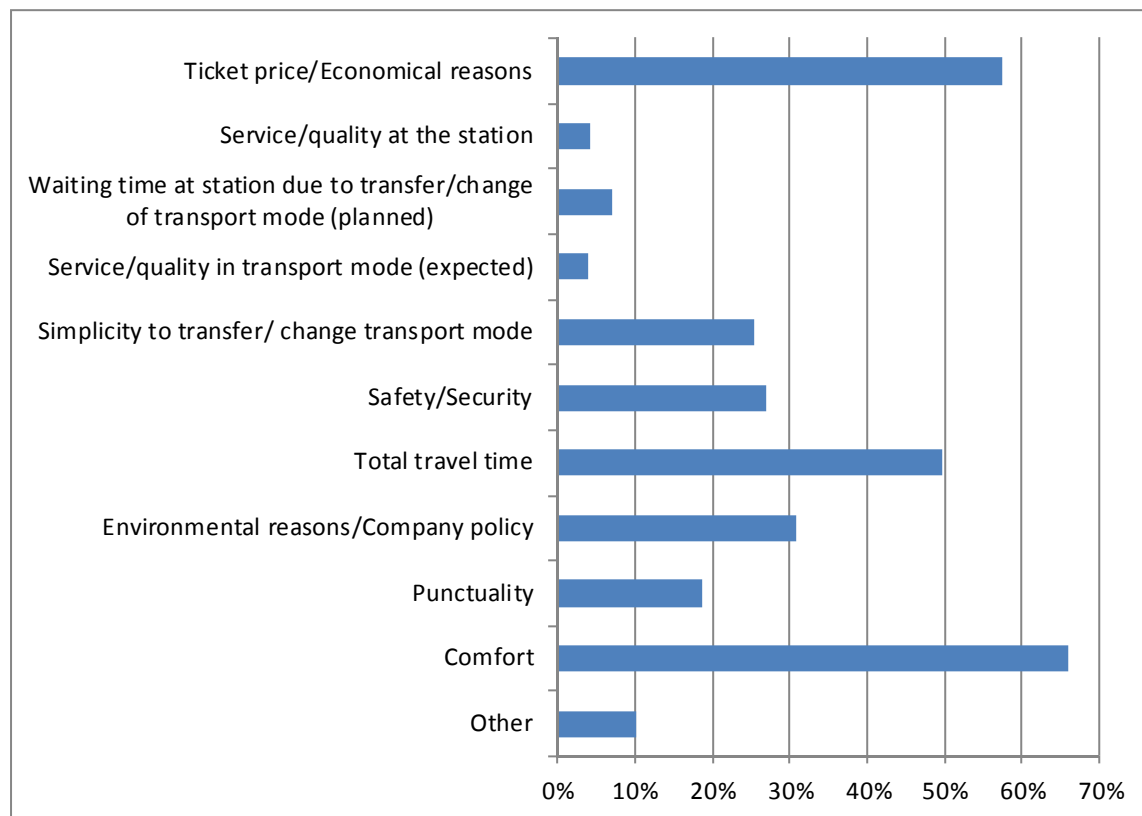


Figure 6.20: The three most important factors which had influence on the choice of transport mode.

6.1.7.3 Time

When it comes to the passengers' perceived quality of services regarding time aspects it can be concluded that the passengers were overall satisfied with the quality of this service (see Figure 17). Passengers were very and quite satisfied with: punctuality (57 percent), transfer time (almost 55 percent) and waiting time (46 percent).

Passengers were quite and very dissatisfied with: punctuality (14 percent), transfer time (9 percent) and waiting time (15 percent).

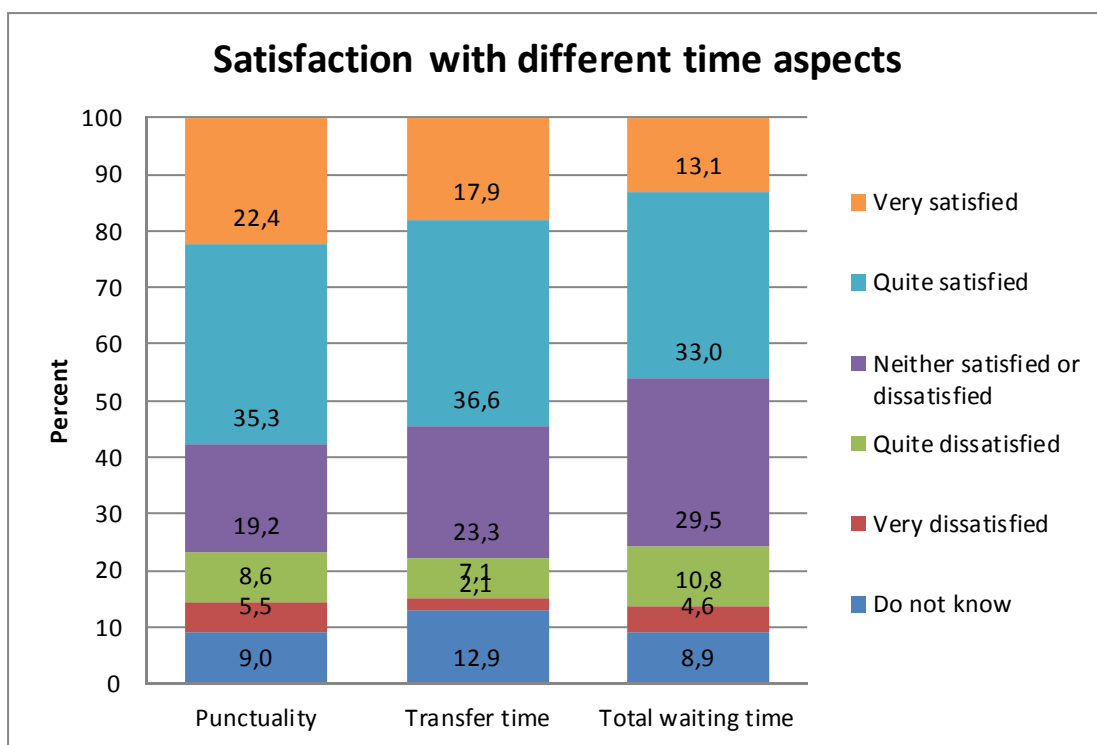


Figure 6.21: Customer satisfaction regarding time aspects at Gothenburg Central Station (Customer Survey).

40 percent of the passengers intended to stay at Gothenburg Central Station between 16-45 minutes and 42 percent more than 45 minutes. About 7 percent of the participants were staying longer due to delays as shown in Figure 18.

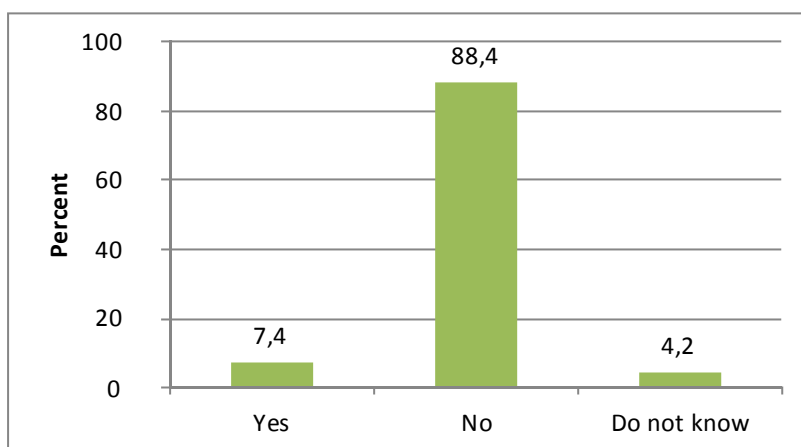


Figure 6.22: Waiting time depending on delays (N=569)

Most of the passengers staying at Gothenburg station were not affected by any delay. Before delays 46 passengers planned to stay in average 25 minutes at Gothenburg Central Station.

6.1.7.4 Space

This chapter describes passengers satisfaction with the space aspect of the site (facilities and distance between gates of Mode 1 and Mode 2 - see Figure 19).

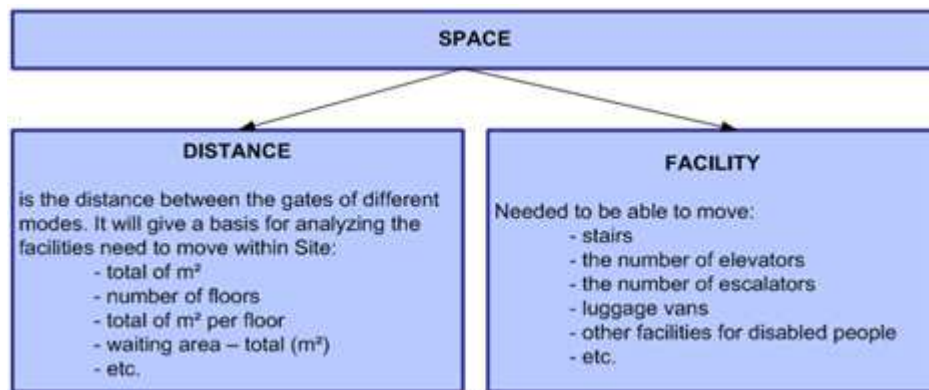


Figure 6.23: Space as the measure of the quality of service

6.1.7.4.1 Distance

76,4 percent of the passengers are quite and very satisfied with the walking distance at transfer (see figure 20).

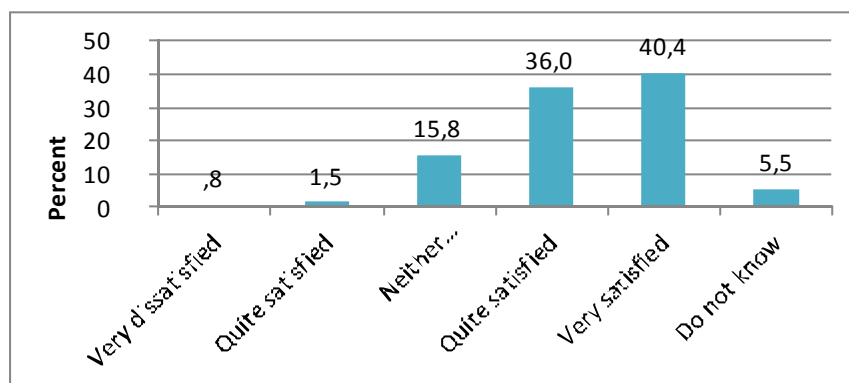


Figure 6.24: Walking distance at transfer (Customer survey, part 2c, q. 15-21, N=525)

6.1.7.4.2 Facilities at the site – observations

The observation study has been divided in two parts due to the different parts of Gothenburg Central Station (see Figure 21). The first one is focused on the railway station (Central House and Central Station, see figure 3 for a map) and the other part has its focus on the bus terminal - Nils Ericsson terminal. Figure 21 shows the number of different facilities at Gothenburg Central Station.

Facilities at the Site	Central House and Central Station	Nils Eriksson Terminal
Trolleys	30	0
Elevator	0	1
Handicap ramp	0	0
Storage cabinets	400	20
Meeting point for escort	1	0
Handicap toilet	1	1
Ladie's toilet	6	3
Men's toilet	6	3
Ladie's shower	2	0
Men's shower	2	0
Telephones	8	5
Exchange machine	2	0
Louonge	2	0
Information about Gothenburg	3	0
Internet café	1	1
Banking service	1	0
Cash dispenser	6	0
Ticket machines	9	8
Ticket sell (number of desks)	8	6
Dining options	7	3
Drug store	1	0
Press bureau	3	1
Rental car services	0	1
Other shops	10	0

Figure 6.25: Observation of facilities

6.1.7.4.3 Facilities at the site – customer satisfaction

Figure 22 below shows that the passengers are overall very and quite satisfied with the facilities at the site.

A great share of the passengers did not know or did not have any opinions about the quality of service “space at the station” (ca 43 percent). Ca 43 percent are very satisfied and quite satisfied and ca 9 percent are dissatisfied passengers.

Aproximately 44 percent of passengers were very and quite satisfied with the quality of “seating capacity at gate/platform” . But a rather high share of the passengers (ca 29 percent) are very and quite dissatisfied.

When it comes to the quality of “total seating capacity” rather high shares of the passengers are quite and very satisfied (ca 51 percent), but there are also ca 23 percent of passengers who are quite and very dissatisfied. It is important to add that ca 22 percent of passenger did not have any opinion.

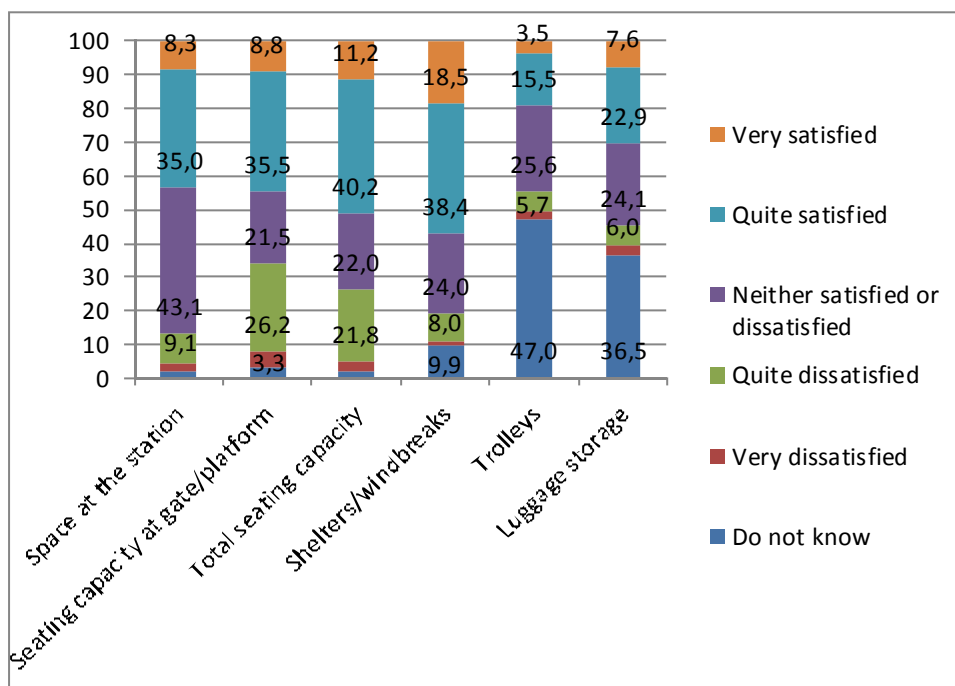


Figure 6.26: Customer satisfaction regarding facilities at Gothenburg Central Station – part I (Customer Survey)

When it comes to the quality of services regarding shelters or windbreaks most passengers are very satisfied or satisfied (ca 57 percent). About eight percent are quite dissatisfied while almost ten percent don’t know.

A great share of the passengers did not know or did not have any opinions about the quality of service regarding trolleys and luggage storage (ca 47 percent and ca 37 percent). This might be

depending on the fact that the Central Station is a rather small interchange and that the passengers are quite satisfied with the walking distance. There could therefore be little need for this kind of services.

Figure 23 below shows customer satisfaction regarding other facilities at Gothenburg Central Station. It's obvious that a high share of passengers did not know or did not have any opinions about the quality of the several services. But, the passengers highlighted access to the toilets (almost 30 percent of passengers were very and quite dissatisfied with this service, see Figure 23) as a problem. According to an open question passengers answered that toilets are too small and too few. By the observation at the site we found out that disabled people have to find cleaning staff to get access to the toilet.

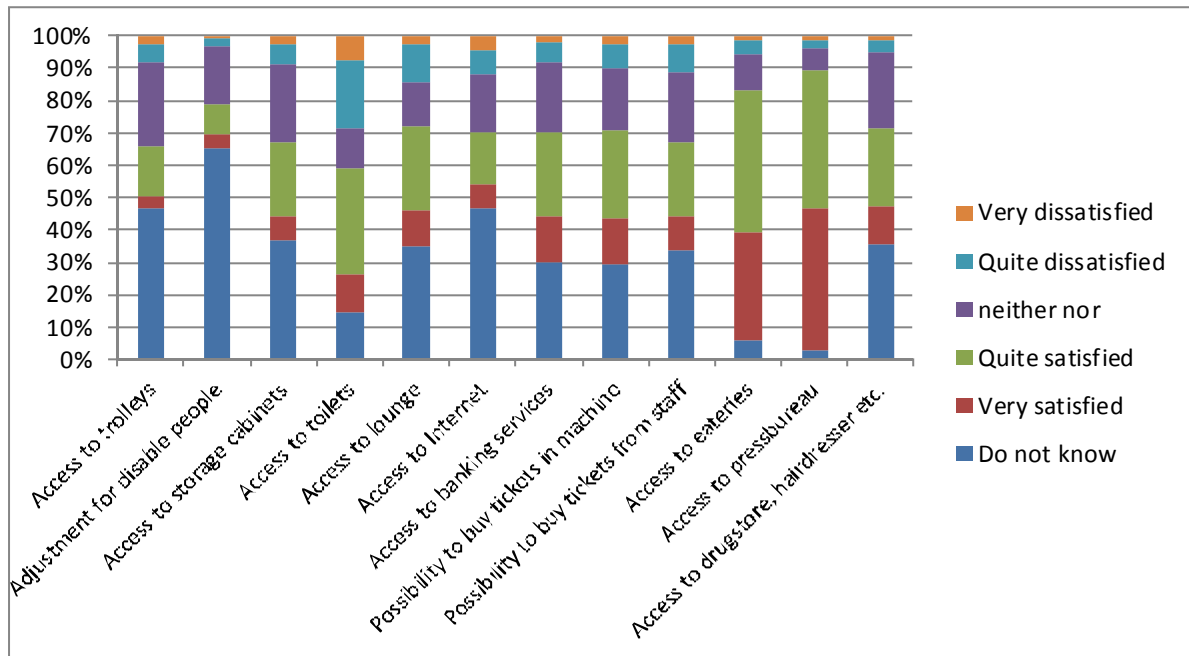


Figure 6.27: Satisfaction regarding facilities at Gothenburg Central Station – part II (Customer Survey).

Only 4 percent of the passengers consider it to be very hard or quite hard to find their gate or platform at the Gothenburg Central Station. So forth most of the passengers consider it to be quite easy or very easy to find their gate at the Gothenburg Central Station. About 90 percent consider that they did not miss something for improving their ability to find the way to the gate (see Figure 24).

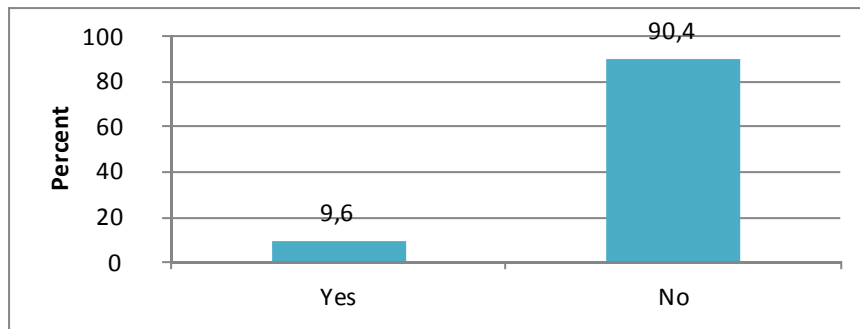


Figure 6.28: Anything missing at Gothenburg Central Station which would simplify the way to the gate or platform (Customer Survey, N=521).

The question about shortcomings or missing functions at Gothenburg Central Station was an open question. The respondents had the opportunity to leave their own view. Most of the written answers were about the information (see Figure 25).

Passengers desired:

- An integrated and less complicated ticket information.
- An integrated time-table for different train and bus traffic operators.
- An integrated information about canceled departures from different traffic operators.
- Information about reason for train delay and magnitude of delay.
- Access to self-service (website and self-service-machine) to check different connection possibilities.
- Better personal information or a guide at the Central Station.
- That information via the loud-speakers is louder, clearer and available in English.

Some passengers had also desired that the signs should be larger, digital (in order to mediate updated information to travelers) and mediate clarity. There were also opinions about the adjustment for visually impaired people. These opinions were about enlarging the size of the gate numbers.

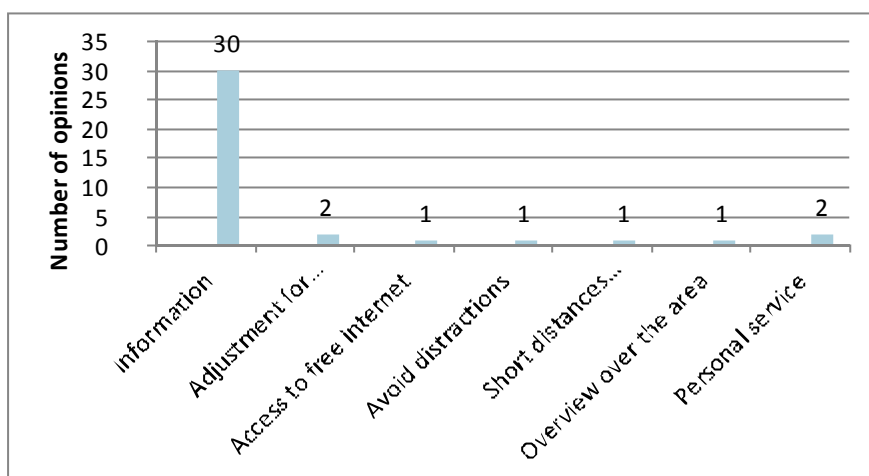


Figure 6.29: Shortcomings or missing functions at Gothenburg Central Station that would make it easier to find the gate (Customer Survey, N=45).

6.1.7.5 *Information, Ticketing and Check-in Services*

6.1.7.5.1 Information and ticketing at the site – observation

There are two different observations about information and ticketing at the site. The purpose of the first observation was to count the number of information desks, signs and ticketing machines. This observation has been divided into two parts due to the different parts of Gothenburg Central Station (see Table 6). The first one is focused on the railway station (Central House and Central Station, see figure 2 for a map) and the other part has its focus on the bus terminal - Nils Ericsson terminal. Table 6 shows the number of different information desks, signs and ticketing machines at Gothenburg Central Station.

Information and ticketing	Central House and Central Station	Nils Eriksson Terminal
Ticket machine	8	9
Ticket sales (number of desks)	8	4
Arrival and departure signage	7	5
Orientation signage	29	18
Information place for visually impaired	0	4

Figure 6.30: Observation at the site – information desk, sign and ticketing machine

There are 38 signs in the ceiling in order to help people to orientate and find their way at the Central Station. This observation also showed the following needs:

- Information signs have to be clearer (for example to use other colors) and
- Adaptation to the people with functional limitations (information via loud speakers).

The purpose of the second observation was to get the average time spent for each passenger at the information desk to get help. According to the data we gained (see Table 7) the average time was calculated as follows:

$$\text{Average time} = \text{Total time} / \text{Total number of passengers}$$

Information and ticketing place	Staff	Observation Time interval	Observation Total time	Number of the passengers who get help
SJ's desk (nr 2)	LF	14:40 – 15:00	20 min	18
SJ's desk (nr 1)	IF	15:40 – 16:00	20 min	29
SJ's desk (nr 1)	LF	16:30 – 16:50	20 min	30
Sj's desk (nr 2)	IF	17:30 – 17:50	20 min	19
Average time			0,83 min	
Västtrafik's desk (nr 2)	LF	14:03 – 14:23	20 min	15
Västtrafik's desk (nr 1)	IF	14:00 – 14:20	20 min	36
Västtrafik's desk (nr 1)	LF	08:00 – 08:20	20 min	30
Västtrafik's desk (nr 2)	IF	09:00 – 09:20	20 min	33
Average time			0,70 min	

Figure 6.31: Observation at the site - average time at information desk per passenger

6.1.7.5.2 Information and ticketing at the site – customer survey

Overall, the passengers are satisfied with the quality of services regarding information and ticketing at Gothenburg Central Station (see Figure 26 below). But, a relatively high share of the passengers don't have knowledge about the level of quality which probably can be explained by the fact that they haven't needed the service during the visit at Gothenburg Central Station.

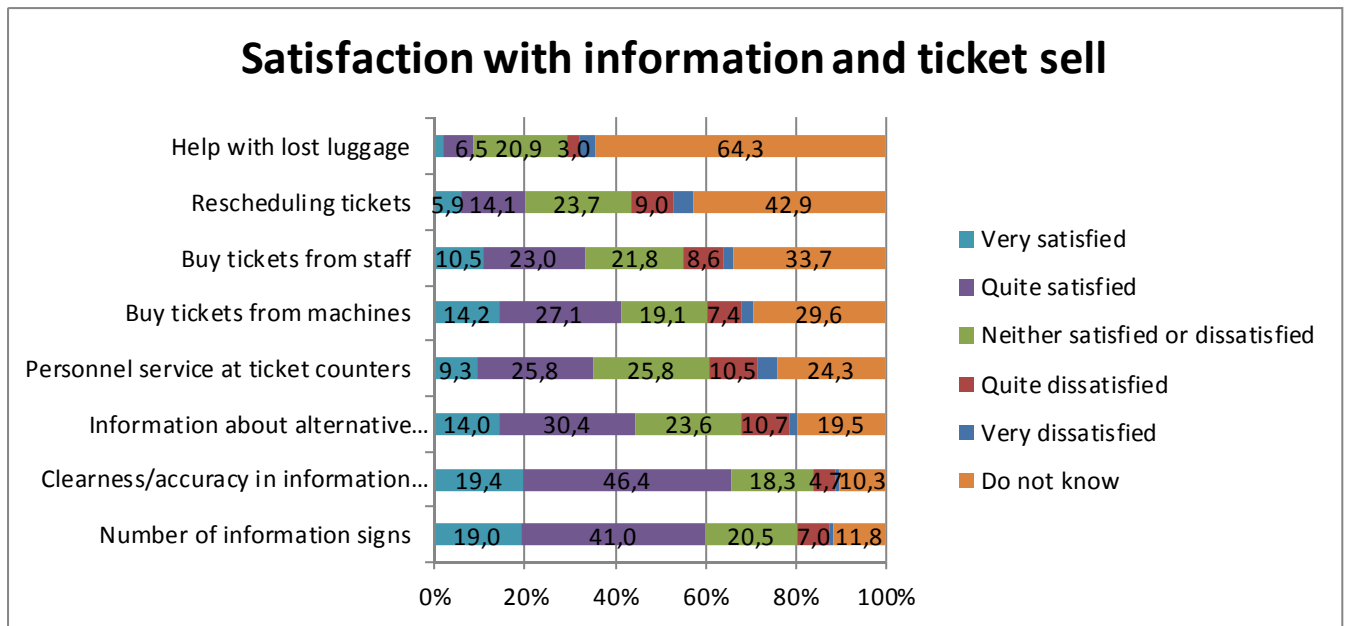


Figure 6.32: Customer satisfaction with information and ticketing at the site (Customer Survey, part 2d, questions 22-24)

The passengers are to a great share satisfied with the number of information signs, 60 percent were very and quite satisfied while 7 percent were quite dissatisfied with the number of information signs.

Most of the passengers (65,8 percent) seem to be very and quite satisfied with the clearness and/or accuracy in the information signs, only 4,7 percent are quite dissatisfied with this factor.

When it comes to information about alternative routes or transport modes, about 11 percent were quite dissatisfied, 44 percent are very or quite satisfied and 24 percent are neither satisfied nor dissatisfied with this service.

Regarding the personnel service at ticket counters, almost 15 percent were quite dissatisfied or very dissatisfied with the service; however, many of the passengers (35,1 percent) were either satisfied or very satisfied with this service. According to the survey a great share, 41 percent are very satisfied or quite satisfied with the possibility to buy tickets from machines and 10 percent are quite dissatisfied or very dissatisfied.

Concerning the ticketing services with staff, 33 percent were very satisfied or quite satisfied, 11 percent were quite or very dissatisfied with the service. About 20 percent were either quite satisfied or very satisfied with the possibility to reschedule their tickets at the Central Station, 13 percent were either quite dissatisfied or very dissatisfied with the same service.

Regarding help in case of lost luggage, about 9 percent were quite or very satisfied and about 7 percent were dissatisfied with the service.

6.1.7.6 Added value at the site

In this section other facilities at the site are described, which gives added value for customers. This is described by three figures (Figures 27, 28 and 29).

Overall the participants were satisfied with the quality of services when it came to the offered facilities at Gothenburg Central Station.

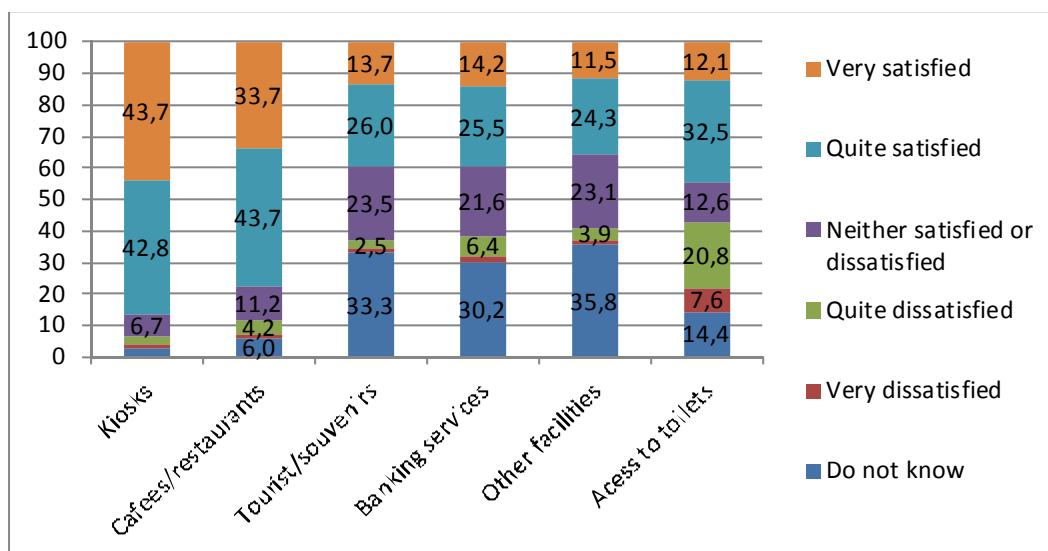


Figure 6.33: Satisfaction with added facilities at Gothenburg Central Station – I (Customer Survey, part 3, questions 25-26)

According to the Figure 27 almost 45 percent of passengers were satisfied with the access to toilets, but a rather high share, nearly 30 percent were quite and very dissatisfied with this service. To improve this service is regarded as an added value.

Figure 28 can be used to highlight a high share of passengers who chose “Do not know” as the answering option. Passengers were in a very high grade very and quite dissatisfied with the following facilities: access to the Internet (20,5 percent), access to lounges (26,6 percent), access to other modes (27 percent) and cleaning of toilets (22,9 percent).

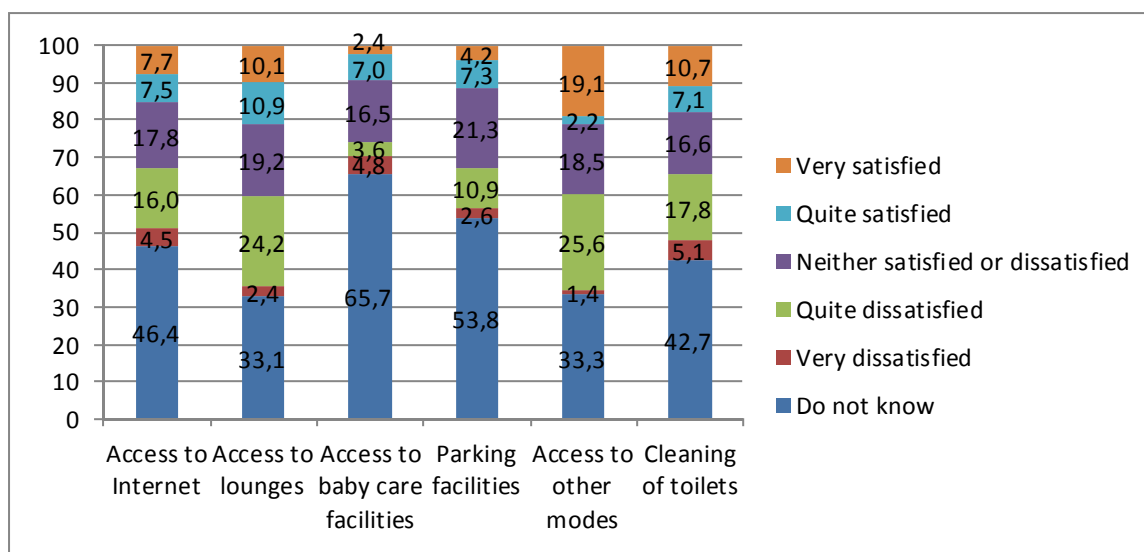


Figure 6.34: Satisfaction with added facilities at Gothenburg Central Station – II (Customer Survey, part 3, questions 25-26)

When it comes to the factors: cleaning of Gothenburg Central Station, ventilation, atmosphere and safety/security (see Figure 29) most of the passengers were very and quite satisfied with the quality of services. In addition, a relatively large share of the passengers were neither satisfied nor dissatisfied. A very little share of the passengers were dissatisfied with these services.

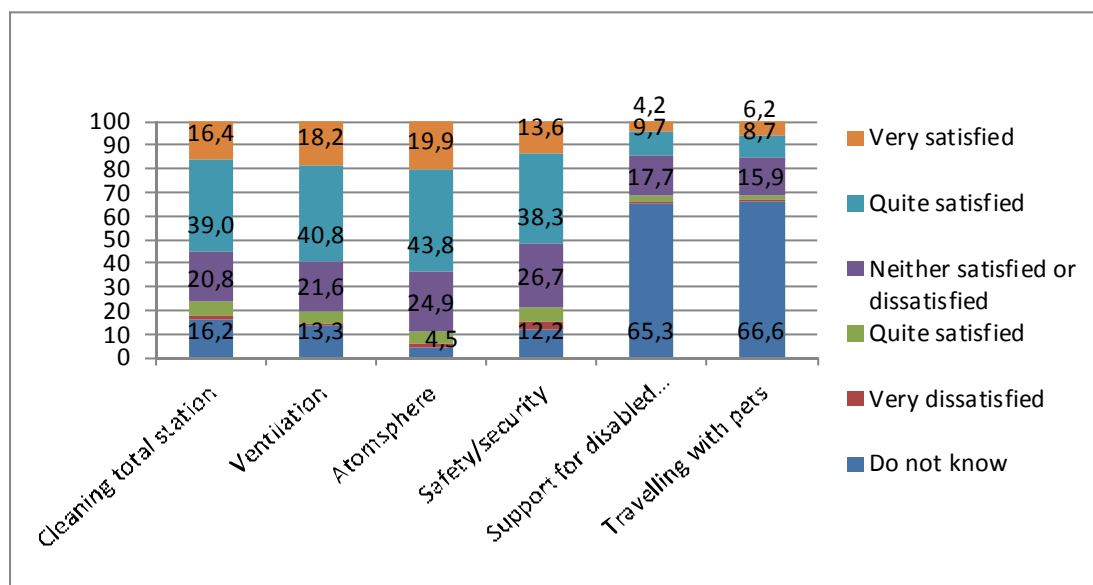


Figure 6.35: Satisfaction with added facilities at Gothenburg Central Station – III (Customer Survey, part 3, questions 25-26)

The services support for disabled people and travelling with pets showed another pattern: a high share of passengers chose the answering option “Do not know”. In addition 16 percent were neither satisfied nor dissatisfied with the service, which gives that these services are not used that much.

6.1.8 Analysis for improvement of interconnectivity

6.1.8.1 Comparison between customers and stakeholders

According to the customer survey and interviews with the stakeholders the current level of quality at Gothenburg Central Station is very high.

Customer's satisfaction is very high with coordinated timetables, possibilities to combine transport modes and walking distance to the transfer. Customers are overall satisfied with facilities at the site. But, according to the customer's answers several possible improvements can be highlighted. These possible improvements have been categorized in two groups: facilities and missing links at the Site.

Group 1 - Facilities:

- **Total seating capacity**
 - The number of seating places are low, especially places nearby the buses.
- **Total toilets capacity**
 - The number of toilets is low.
 - The toilet's area is narrow.
 - Customers would like toll-free toilets.
- **Service 1: Cleaning of toilets**
 - Toilets are considered as very dirty by customers.
- **Service 2: Mobile Internet/WIFI at the station**
 - The customers would like to have access to the mobile Internet/WIFI at the station.
- **Service 3: Security at the Site**
 - The customers would like to have more guards at the site, especially in the evenings and during weekends.

Group 2 – Missing links at the Site

The question about shortcomings or missing functions at Gothenburg Central Station was an open question. By analyzing answers from the customers the following missing links become clear:

- **Better information**
 - Different railway operators have different ticket types. It's confusing for customers and they would like to have possibilities for an integrated and less complicated ticket information.
 - Information about cancelled departures from different transport operators should be integrated and available at one place.
 - The customers would like to have access to self-service (website och self-service-machines) to check different connection possibilities.
 - The customers would like to have an integrated time-table for different railway operators.
 - The customers would like to have an integrated time-table for different bus operators.
 - Information about why the train is delayed and how much should be available.
 - Information via the loud-speakers must be louder, clearer and in English.

- Customers demand better personal information or a guide at the Central Station.
- Better signing to the bus departure
- Signs should be larger, digital (in order to give updated information to travelers) and mediate clarity.
- Better personal information or a guide at the Central Station.
- Gate numbers should be adjusted for visually impaired people vision.

6.1.8.2 Validation of findings in WP3/WP4

Interconnectivity barriers and measures developed and proposed in WP3 and WP4 – “Maintain/ increase the information quality and standard at the station in order to maintain/ increase the customer satisfaction” - has been confirmed by customer survey.

6.1.8.3 Missing links and new Value Proposition

At the Gothenburg Central Station there are a huge number of different actors. There are about twenty different actors who are delivering transport services and there is a lack of an integrated information. A new Value Proposition for the Gothenburg Central Station is to:

“Create a new way to integrate and distribute information on various transport services provided by different transport operators.”

6.1.9 Actions for improvement of interconnectivity

6.1.9.1 Proposal

The main concept of our proposal is to: “Integrate traffic information on various transport services provided by different transport operators and make this information available to customers”.

This can be achieved by introducing a new agent at Gothenburg Central Station. This/these new agents are here called “Traffic Information Brokers” and their task should be to create a new and innovative way to integrate and distribute traffic information. They can also have traffic information centers at the Site.

6.1.9.2 Description of new business model

Figure 30 (see below) describes our proposal for new business model.

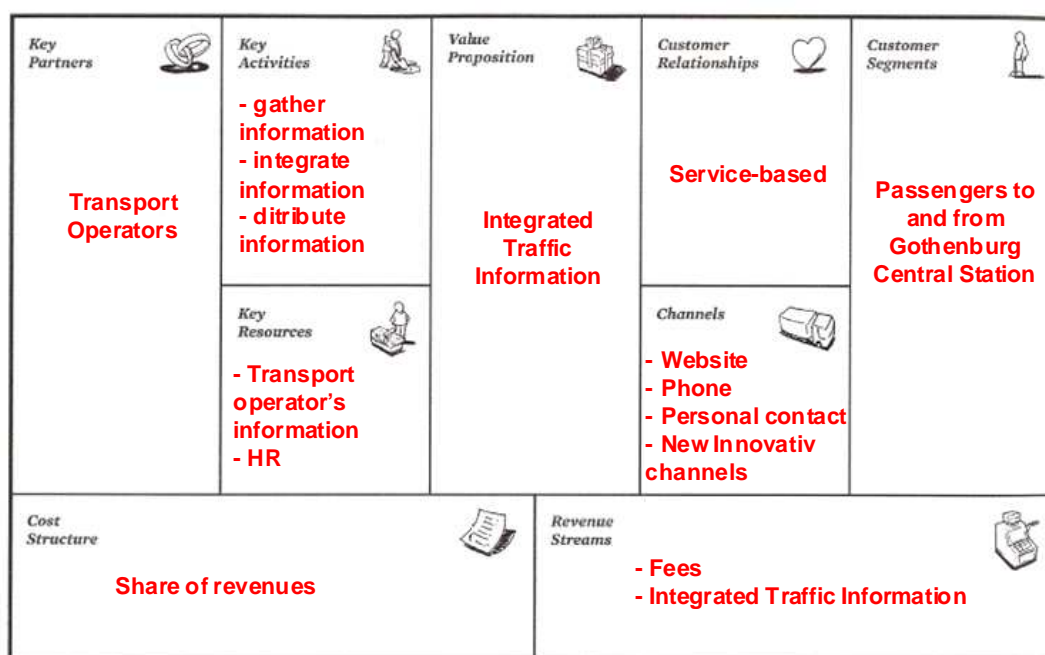


Figure 6.36: Business Model - Integrated Traffic Information

6.1.9.2.1 Customer Segments (CS)

Traffic Information Brokers' customers are all passengers to and from Gothenburg Central Station. This service is very important for people with reduced mobility.

6.1.9.2.2 Value Proposition (VP)

The main value is an Integrated Traffic Information on various transport services provided by different transport operators. Customers (passengers) can use this information to plan their

trips (e.g. short/long distance, different types of transport modes, etc). The most critical service level for this information is information reliability.

6.1.9.2.3 Channels (CH)

There are several possible channels to distribute information: Internet, mobile telephone, website, visual information at the Site, audio information at the Site, signs, direct (personal) contact to the customers and so on.

It is possible for the new agent/agents (e.g. Traffic Information Broker) to make new and innovative channels for information distribution.

6.1.9.2.4 Customer Relationships (CR)

Customer relationship is service-based. Customers can interact with the Traffic Information Broker using all possible channels.

6.1.9.2.5 Revenue Streams (R\$)

The main revenue sources for Traffic Information Brokers could be fees from different transport operators. Integrated information available for customers is the main revenue stream for all other agents (transport operators, terminal manager, etc.).

6.1.9.2.6 Key Resources (KR)

The information is going to be the key resource. Human resources needed can be following:

1. Information architectures
2. IT-technicians
3. Marketing managers
4. Staff at the Site
5. Office

6.1.9.2.7 Key Activities (KA)

Major activities are: gather information, integrate information from different transport operators and to distribute integrated information to the customers.

6.1.9.2.8 Key Partnerships (KP)

Key partners should be transport operators, decision makers and terminal manager.

6.1.9.2.9 Cost Structure (C\$)

The cost structure might be a challenge. One important cost structure is the share of revenues. Probably, the new agents (Traffic Information Brokers) are going to be private companies and these are going to charge for integrating the information. Information management is a very

large cost for many companies and it is necessary to find solid financial solutions. This is going to be a main challenge for the Traffic Information Brokers.

6.1.9.3 Description of proposed service using the concept of Agents

We choose to describe our proposal of business model using the graph (see Figure 31). January 1st 2012 the Swedish passenger transport sector will be fully de-regulated. This implicates an uncertain business model at Gothenburg Central Station. The risk of getting a situation with less co-ordinated information and confusion among travellers can be solved by Traffic Information Brokers. They can gather information from different transport operators and make it available to the customers.

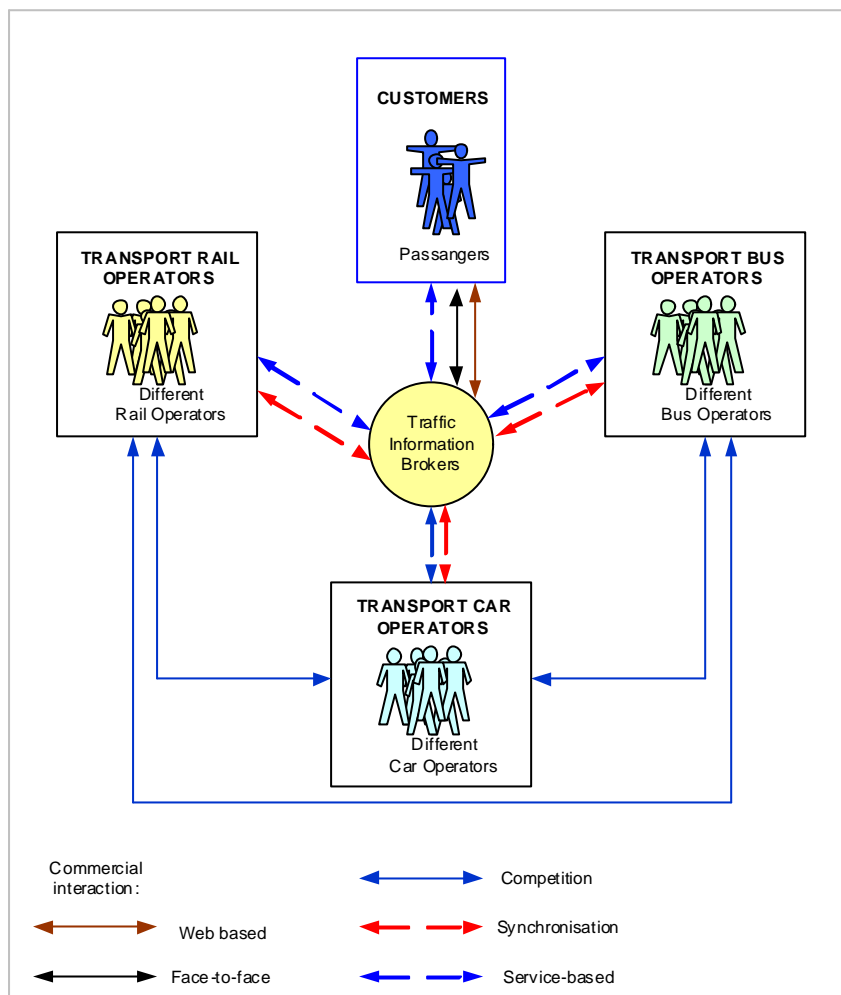


Figure 6.37: Traffic Information Broker as a agent in new Business Model

6.1.9.4 Functions and Indicators to show enhancement

6.1.9.4.1 Functions of validation

The new added value with the business model is to give the customers integrated information from different transport operators via one agent, the new agent called traffic information broker.

1. Customers can find all information integrated and on one place (e.g. website, display, etc.)
2. Customers can use this information to plan their travel and find the optimal route for travel.
3. Customers can get information from all transport operators at the Site

6.1.9.4.2 Indicators of validation

The indicators for the validating the functions could be:

1. The number of customers using this new service
2. The customer's satisfaction with the new service

6.1.9.4.3 Methods and tools

The number of customers using the service are counted. A customer survey can measure the satisfaction with the new service.

6.1.9.5 *Demonstration and Evidence of Improvement*

The validation process is quite straight forward as the number of customers using the service can be counted in an easy way, by website hits or by personell counting. A customer survey will measure the customers' satisfaction with the new service.

6.1.9.6 *Added value to the HERMES project*

The case study of Gothenburg central gives added value to the HERMES project mainly when it comes to:

1. Knowledge and experiences from traffic disturbances and de-regulation and the effect that has on the passenger
2. Knowledge about information to the passenger and co-operation between new actors.

6.2 Avenida de América Interchange Madrid, Spain

Avenida de América is an interchange located in the city of Madrid, in the interface between the A-II motorway and the M-30 orbital road, collecting the flows from the so called Henares corridor and the North-East of Spain. This is a dense part in the NE of the city, only 1.6 km from Castellana Av (Paseo de la Castellana) which is the central artery of the Madrid CBD.

Within the Madrid Regional Plan to built passenger public transport interchanges the Avenida de America Interchange is one of the main infrastructures for achieving the goal of seamless mobility between long and regional journeys and their distribution in urban trips.



Figure 6.38 Location of Madrid in the Iberian Peninsula

The Madrid Region (Comunidad Autónoma de Madrid) is one of the 17 Autonomous Regions within Spain. It has 8.000 km² and 6 million inhabitants. Mobility patterns are not homogeneous: their complexity is related to the population density, land use and the supply of the different means of transport.

Transport interchanges play an important role within this context in order to enhance long-/short distance intermodality, being located in the border of the CBD of Madrid.

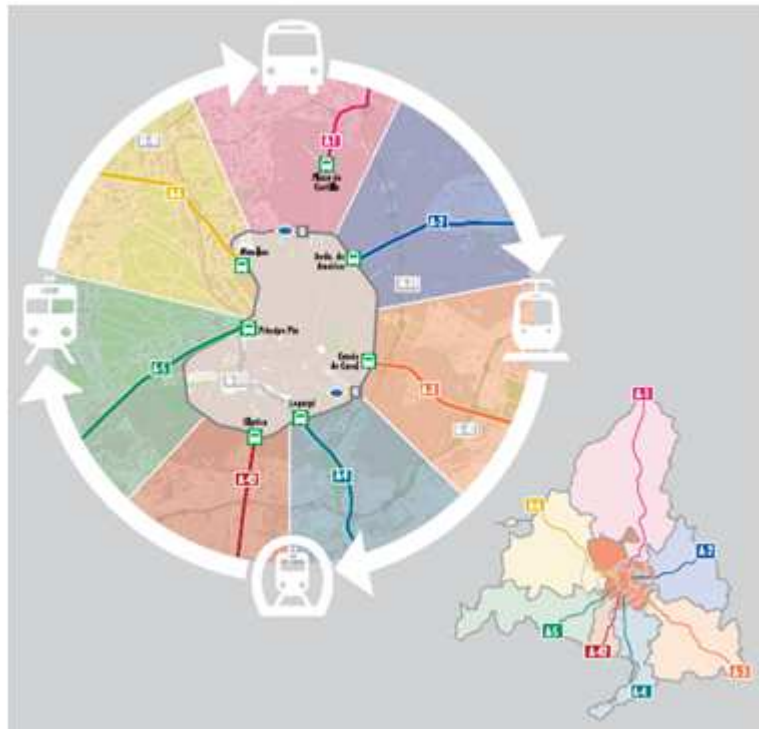


Figure 6.39 Location of Avenida de América Interchange



Figure 6.40 The interchange of Avenida de América

6.2.1 Main features of the site

Avenida de América interchange came into service in 2000. It is structured in four underground floors, with a rectangular layout (208 x 49 meters). The structure reaches a total depth of about 16 meters.

Level “-1” is assigned to long-distance buses and has 18 platforms; level “-2” was designed for urban and regional buses and has 19 platforms; levels “-3” and “-4” are dedicated to the underground network connection (Metro) and the rotation (253 places) and residents (392 places) car parking. Commercial areas, together with ticket offices, are located at levels “-1” and “-3”.

Since 2009 the interchange has been revamped (the works will end in 2011 for a total expenditure of 40 million euro); particularly, the following issues will be improved: air conditioning, safety/security facilities, platforms screens, transfer walkways, etc.

The main feature of the interchange is that regional buses (level “-2”) accede directly from the A-2 motorway by dedicated tunnels to the bus bays, thus reducing congestion in the surrounding area, as well as travel time for passengers.

The interchange shows a vertical design and has a good accessibility thanks to a sort of measures implemented for mobility and visually impaired passengers, such as lifts, escalators, signage, etc.

Bus platforms are protected by screens which provide climate control, sound proofing and fire protection. Furthermore, they allow extracting the exhausting gas from the buses, thus increasing air quality in the passengers’ waiting areas. The furniture used (benches, rubbish bins, etc) was designed taking into account that it will be used extensively and maintenance should be easy.

Information systems have been implemented to coordinate the interchange operation, access and departure management, security control and car parking. Ticketing integration is still a weak point for the interchange, since long and short distance modes have separate ticket offices and different strategies.

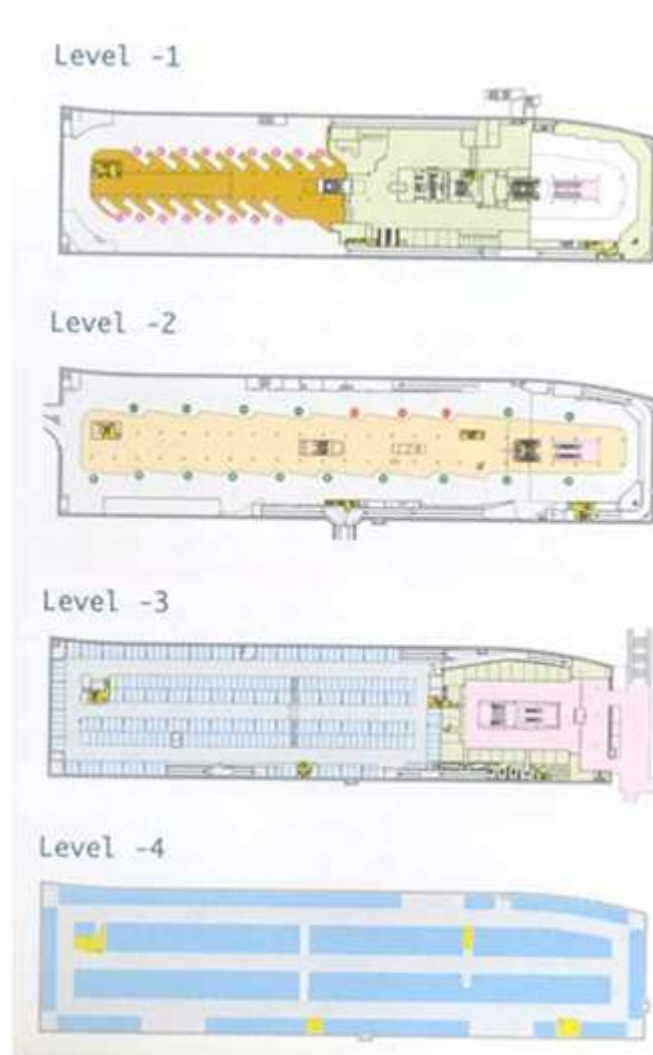


Figure 6.41 The four levels

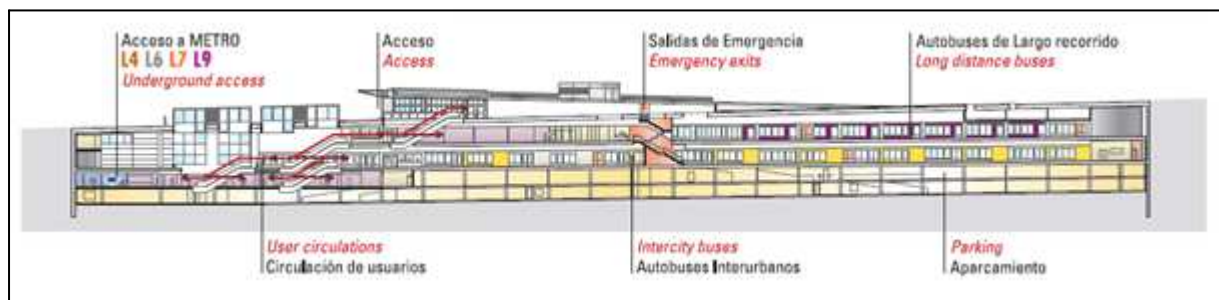


Figure 6.42 Cross-section of Avenida de América interchange



Figure 6.43 Interchange renewals.



Figure 6.44 Tunnel and car parking at the Interchange.



Figure 6.45 Interchange accessibility.



Figure 6.46 Waiting areas/spaces in the Interchange.



Figure 6.47 Ticketing systems in the Interchange.

6.2.1.1 Identification of the site

Transport modes	Rail	Bus	Air	Car	Ship and ferry
Geographical coverage	Rail services	Bus services	Air services	Car services	Ship and ferry services
a) Long distance services >100 km	1) International rail service	1) International bus service	1) International air service	1) Taxi 2) Mobility service for passengers with disabilities	1) International ship service (ocean liners) 2) International ferry service
b) Long distance air services >700 km	2) Interurban rail service	2) Interurban bus service	2) Interurban air service	3) Privat car 4) Rental car	3) Port-to-Port ferry service
a) Short distance services <100 km	1) Metro service 2) Tram service 3) Commuter train service	1) Interurban bus service 2) Urban bus service 3) Shuttle service	1) International air service 2) Interurban air service	1) Taxi 2) Mobility service for passengers with disabilities 3) Privat car 4) Rental car	1) Port-to-Port ferry service 2) Pier-to-Port ferry service 3) Pier-to-Pier ferry service
b) Short distance air services <700 km	4) Interurban rail service				

Figure 6.48: Long-distance services and short-distance services per mode

6.2.1.1.1 Geographical coverage - Long distance

6.2.1.1.1.1 International

ALSA, the long distance operator, offers services from Avenida de América interchange to six European countries:

- Germany (2 different destinations)
- Czech Republic (1 different destination)
- France (12 different destinations)
- Poland (25 different destinations)
- Portugal (12 different destinations)

Switzerland (5 different destinations)

Lines to Portugal, France and Poland are the most demanded, and buses from Avenida de América do not reach South European destinations, covering a 40 % of the destinations offered by the company to different European countries.

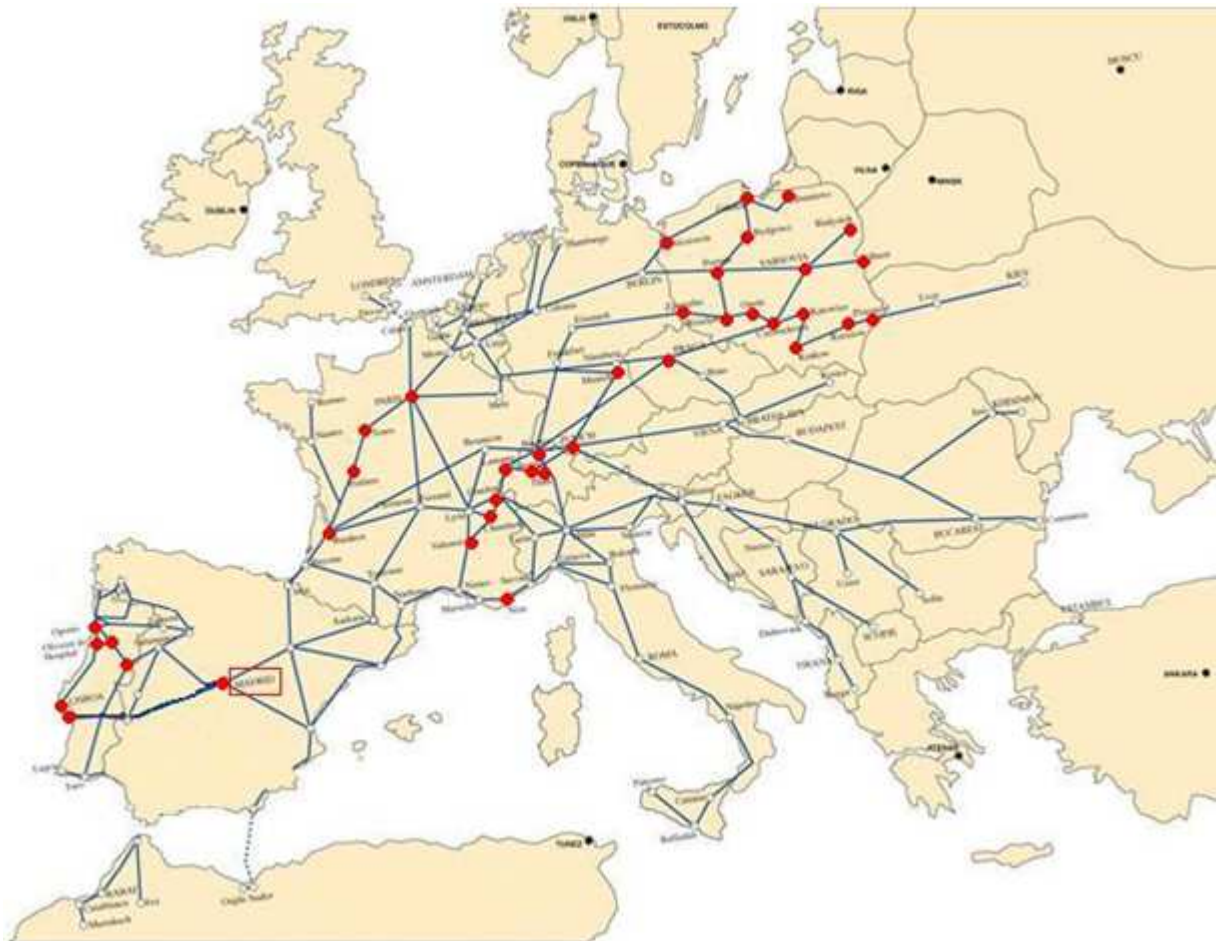


Figure 6.49 Geographical coverage. Long distance. International.

6.2.1.1.2

6.2.1.1.2.1 National

Alsa offers services from Avenida de América Interchange to eight Regions:

Andalucía (15 different destinations to Cádiz, Córdoba, Granada, Huelva, Jaén, Málaga and Sevilla provinces)

Aragón (one destination to Zaragoza province)

País Vasco (3 different destinations to Álava, Guipúzcoa and Vizcaya provinces)

Cantabria (3 different destinations to Cantabria province)

Castilla y León (5 different destinations to Burgos, Guadalajara and Soria)

Cataluña (5 different destinations in the provinces of Barcelona, Gerona, Lérida and Tarragona provinces)

La Rioja (one destination to Logroño province)

Navarra (2 different destinations)

Thus buses go basically to the North- East and to the South- West part of Spain, covering approximately a 30 % of the destinations offered by the company.



Figure 6.50 Geographical coverage. Long distance. National.

6.2.1.1.3 Geographical coverage - Short distance

6.2.1.1.3.1 Regional buses

Continental Auto, Argabus and Turística de Autobuses are the operators responsible for providing regional bus services.

Within the Madrid Region there are 14 lines departing from Avenida de América interchange to the following destinations: Barajas, Alcalá de Henares, Torrejón de Ardoz, Nuevo Baztán, San Fernando de Henares, Coslada, Loeches.

Metro is the company that operates the underground railway services in Madrid. The stops are usually in town, but line 7 and line 9 go out of the city, stopping at: Coslada, San Fernando, Vicálvaro and Arganda del Rey.

Regional services cover the east part of Madrid.

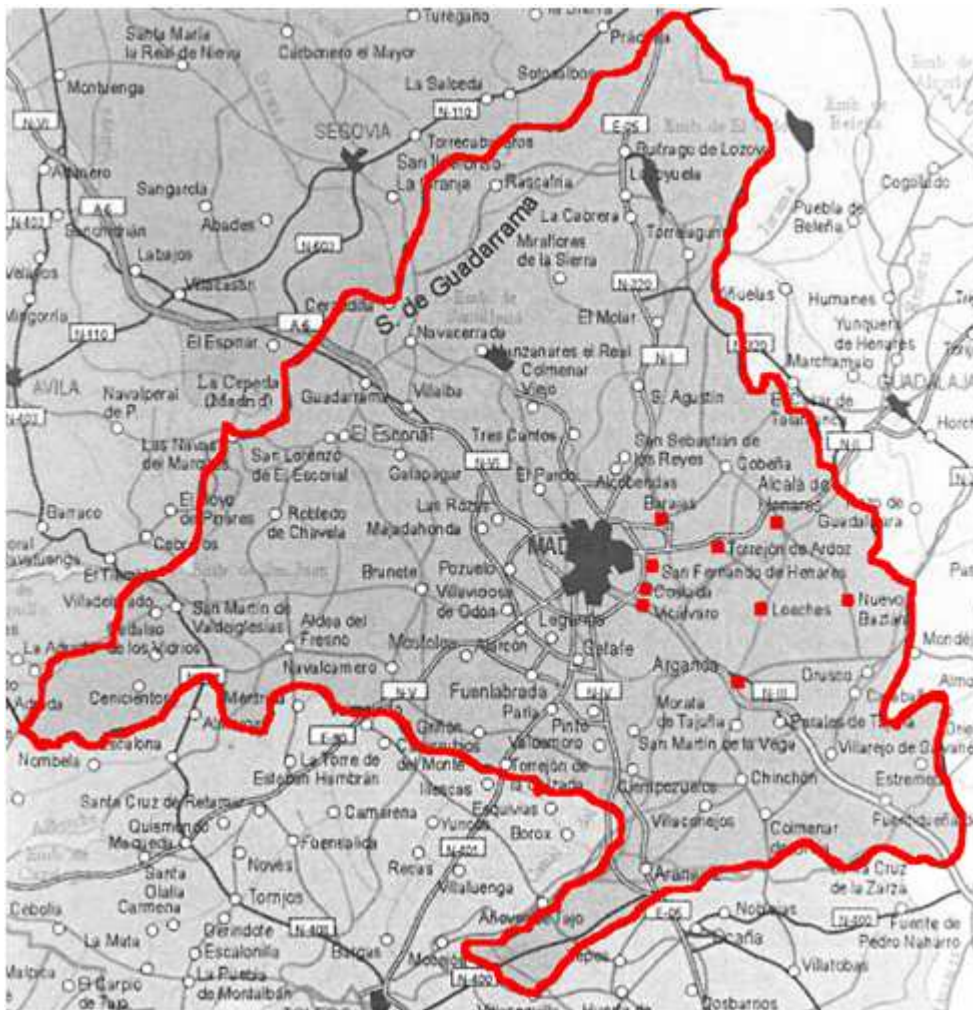


Figure 6.51 Geographical coverage. Short distance. Regional.

6.2.1.1.4

6.2.1.1.5 Geographical coverage - Urban

6.2.1.1.5.1 Urban buses

EMT (Empresa Municipal de Transportes) is the municipal public company operating urban bus services in Madrid. The services offered at the Interchange are:

10 regular lines covering the principal points of interest (Moncloa Interchange, Sol, Atocha Station, Paseo de la Castellana, Retiro Park, among others)

6 night buses (apart from the 24 hours airport line)

The figure 13 shows a map with the lines stopping at Avenida de América.

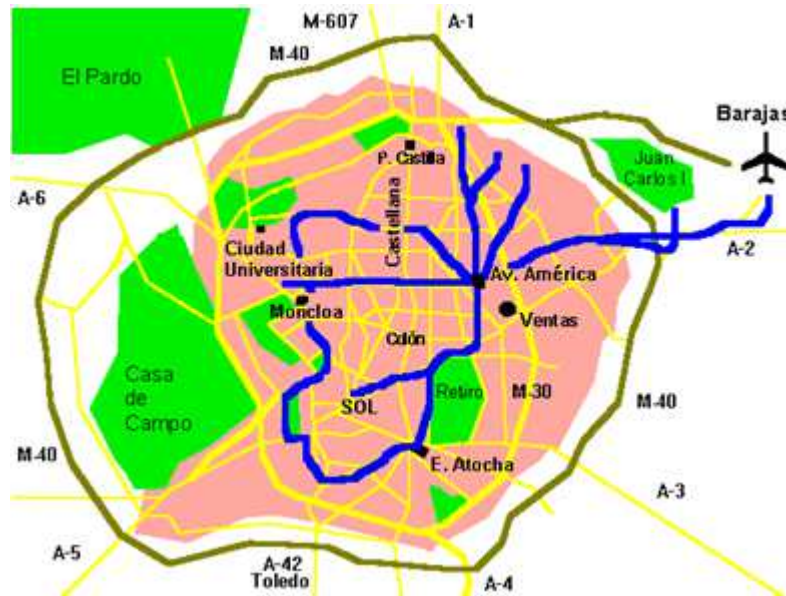


Figure 6.52 Geographical coverage. Short distance. Urban bus services.

6.2.1.1.5.2 Metro

Metro is the public owned company operating underground railway services in Madrid.

The Metro lines with stop at Avenida de América are:

4 lines covering many of the relevant locations on the above map (and going beyond bus lines). In addition, bearing in mind that one metro ticket is valid for all metro lines, access to the whole city of Madrid is assured, including transfers.

The figure 45 shows a map with the metro lines that stop at Avenida de América.

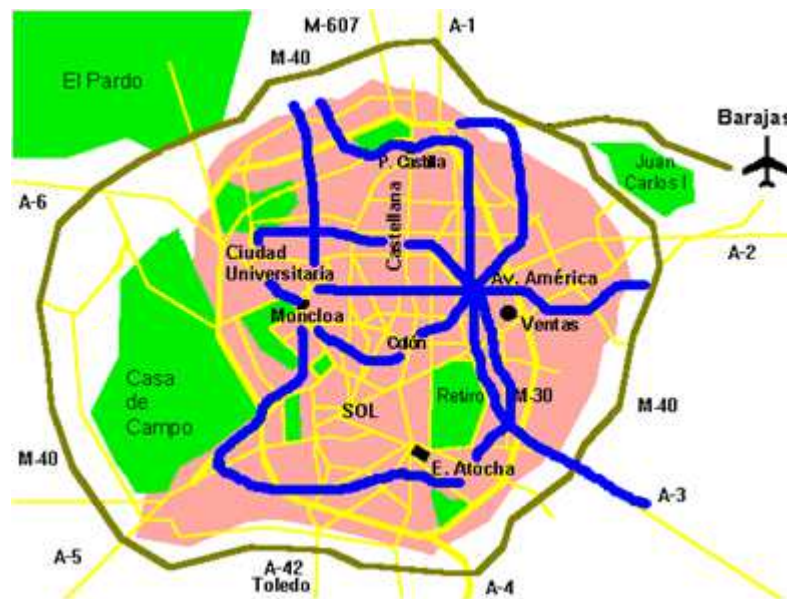


Figure 6.53 Geographical coverage. Metro services.

6.2.1.1.6 Transport modes

At the interchange buses, Metro lines and taxi services operate (these latter on the surface, out of the interchange), covering all three levels of the HERMES interconnectivity domains:

- Interfaces and interconnections between different modes;
- Interfaces and interconnections between different types of services of the same mode;
- Interfaces and interconnections between high capacity and low capacity mode.

Particularly, the following transport services are provided:

Long distance services

Long distance bus

- 19 lines to different destinations, mainly to the North of Spain (Burgos, Bilbao, Santander, Zaragoza, Barcelona, Granada, Pamplona, etc)

Short distance/regional services

Metro service

- Line 4 (Pinar de Chamartín - Argüelles)
- Line 6 (circular line)
- Line 7 (Hospital de Henares - Pitis)

- Line 9 (Herrera Oria - Arganda del Rey)

Regional bus

- 14 lines to different destinations of the Corredor de Henares (Guadalajara, Alcalá de Henares, Torrejón de Ardoz, etc)

Urban bus (EMT)

- 9 regular lines
- 2 circular lines
- 6 night bus services (Búhos)
- shuttles to Barajas airport

Taxi service

6.2.1.1.7 Services per transport mode - Seats per mode

6.2.1.1.7.1 Long distance

ALSA long distance buses usually have 50 to 60 seats, although there are also buses from 40 to 50 seats.



Figure 6.54 Long distance buses.

6.2.1.1.7.2

6.2.1.1.7.3 Short distance - Regional buses

The average capacity of regional buses is 72 passengers per bus, 50 seated.



Figure 6.55 Regional bus.

6.2.1.1.7.4 Urban buses

The average capacity of urban buses is 100-110 passengers per bus, 20-30 seated.



Figure 6.56 Urban bus.

6.2.1.1.7.5 Metro service

Capacity depends on type of train, and each line with stop at Avenida de América uses a different one:

- Line 4: 738 passengers per train (120 seated)
- Line 6: 384 passengers per train (64 seated)
- Line 7: 1096 passengers per train (178 seated)
- Line 9: 1170 passengers per train (197 seated)



Figure 6.57 Metro car.

6.2.1.1.8 Lines per mode and peak period - Short distance

Frequencies of the different services are the following:

6.2.1.1.8.1 Regional buses

Regional buses have different timetables and schedules depending on the demand of the line, but most of them operate from 7 to 23 hours with frequencies varying from 15 to 30 minutes. Each line has capacity for 120 - 240 passengers per hour, or 1920 passengers per day

6.2.1.1.8.2 Metro service

Metro service operates 22 hours a day except from 2 to 6; passing frequencies are more or less the same for all the lines.

- From 7 to 21 hours the trains have a frequency of 3-5 minutes.
- From 6 to 7 hours and from 21 to 2 hours trains have a frequency of 4-15 minutes.

With the capacity of each train mentioned before this means capacities for each line that go from 5760 to 17550 passengers per hour when there is more demand, or from 2300 to 7020 passengers per hour when there is less demand.

This is a really high capacity that is in agreement with the elevated number of passengers using the metro to get to the interchange.

6.2.1.1.8.3 Urban buses

Urban buses, as well as regional buses have different timetables and schedules depending on the demand of each line, but most of them operate from 7 to 24 hours and have frequencies from 5 to 20 minutes, each line has a capacity of 100-200 passengers per hour or 1700- 3400 passengers per day.

6.2.1.1.9 Parking places

There is a car park with 253 spaces, which is not a high number (very few passengers get to the interchange by car, because it is very well connected by public transport among other reasons).

There is no special parking for motorcycles and bikes.

6.2.1.1.10 Places reserved for disabled travelers

6.2.1.1.10.1 Long distance

ALSA buses don't have reserved places for disabled, but they offer facilities like ramps and so disabled people can travel. Anyway the company must be informed in advance.

6.2.1.1.10.2 Short distance

Every bus or Metro train has at least one place reserved for disabled, with the necessary safety devices.

6.2.2 Method for data collection

The planning and overall organisation tasks for case study n. 4 fall on all TRANSyT-UPM members.

6.2.2.1 Observations and collected material

6.2.2.1.1 Transport demand/Passenger flow

Data gathered from both customers' and stakeholders' survey

6.2.2.1.2 Time data

Data gathered from the customers' survey, questionnaires were distributed on Wednesday 11, Thursday 12 and Friday 13 of April, 2011; from 7.00 to 21.00 hours.

6.2.2.1.3 Space data

Data gathered in Long distance quays, from the customer's survey.

6.2.2.1.4 Information, Ticketing and Check-in Services data

Data gathered from both customers' and stakeholders' survey

6.2.2.2 *Customer survey*

6.2.2.2.1 Sample size

Questionnaires were made to 383 passengers in the interchange.

6.2.2.3 *Stakeholder interviews*

Interviews did take place in Stakeholders offices, and have lasted from one to two hours.

6.2.3 Stakeholders at the site

Following the Agent Based Modelling (ABM) suggested by WP2, the agents present at the WP3 case study Avenida de América interchange as surveys and personal interviews have evidenced, are as follows:

- Decision Makers
- Terminal Manager
- Operators

However, we have added Users in this section, since they are, obviously, a part of the whole transport scheme and a invaluable font of information.

In the following sections we deal with this concept (agents) regarding several aspects needed for the validation of our prototype of business model.

6.2.3.1 *Description of Stakeholders*

The main stakeholders for this case study are the following ones:

CRTM – Consorcio Regional de Transportes de Madrid

The Madrid Transport Authority came into service in 1986 with the purpose of coordinating services, combining the efforts of both public and private institutions regarding Public Transport, networks and fares so as to offer consumers a higher-capacity and higher-quality service. CTRM is the authority empowered to grant the Avenida de América interchange.

Ayuntamiento de Madrid

The municipality of Madrid is the owner of the land and the car-parking lots surrounding the interchange.

Terminal manager of the interchange

Is the one responsible for the interchange's managements, meaning operational, maintenance and monitoring issues, coordination among transport services, emergency situations, etc. The CRTM appoints the terminal manager.

Transport operators: public and private companies

As regards bus services, ALSA/Continental and PLM Autocares are the main operators for long distance services, whilst both ALSA and ETASA are the companies providing regional bus services at the interchange. They are all private companies. Urban bus services are operated by EMT – Empresa Municipal de Transportes de Madrid, which is the municipal bus company. Metro de Madrid is the company operating the Madrid underground services in Madrid. Taxi services are also operating at the station (outside).

Other services: private companies

There are also private companies dealing with transport services and other issues: rental car companies, commercial and retail activities, cafés etc.

6.2.3.2 Interaction between Stakeholders

			Terminal manager	Transport operators 	Other companies
	<p>The Transport Authority combines the efforts of public and private institutions related to Public Transport for the purpose of coordinating services, networks and fares.</p>		<p>The Transport Authority is responsible for the appointment of the terminal manager,</p>	<p>The Transport Authority coordinates public and private operators.</p>	<p>The CRTM outlines rules, procedures, standards for retailers and the provision of additional service within the interchange.</p>
		<p>The municipal government is responsible for planning and regulating urban public transport (Department of transportation / mobility).</p>		<p>The municipal government contracts out the provision of passenger services by the private sector.</p>	<p>It collaborates with CRTM to set the level of retailer rents,</p>
Terminal manager	<p>The terminal manager informs CRTM about services operations, incidents, alterations, etc.</p>		<p>He manages the interchange and define the agents to contract.</p>		<p>He controls that companies operating at interchanges respect the regulatory framework.</p>
Transport operators 	<p>Rail and bus companies pay operating fees for use of infrastructures and/or facilities.</p>		<p>Transport operators provide transport modes through agreements with the infrastructure manager.</p>	<p>Rail/bus companies are responsible for transport operations, vehicle maintenance, etc.</p>	
Other companies	<p>Retailers and other shopkeepers pay a fee to provide their service at the interchange.</p>				<p>Retailers and other companies provide additional service at th interchange,</p>

Figure 6.58 Interaction between stakeholders

6.2.3.3 Graphical representation

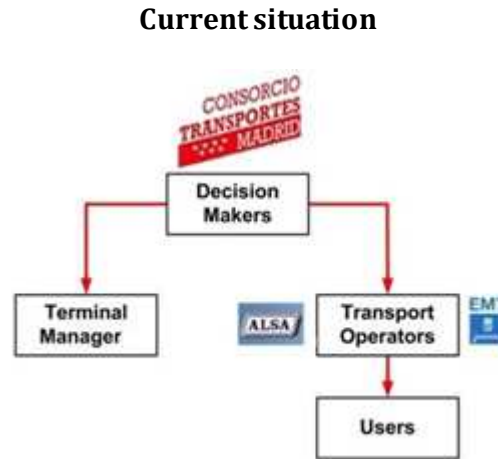


Figure 6.59 Graphical representation

Transport Authority (Decision Maker) coordinates public and private **Operators**

Transport Authority is responsible for the appointment of the **Terminal Manager**

Terminal Manager manages the interchange, defines the agents to contract and controls that the

Transport Operators are respecting regulation

Transport Operators provide service to **users**

6.2.4 Current short-long interconnectivity problems/opportunities

Problems and opportunities at Avenida de América interchange can be summarised in five key-issues, the first two of them are going to be improved with the renewal that is being carried out:

1. Since the structure itself is vertically developed, transfer times are quite high. Specially accessibility from level “-3” to level “-4” has to be improved: there is a lack of escalators which prevents mobility impaired passengers. The current revamping of the interchange will improve access/transfer times for passengers.
2. Environmental conditions, i.e. noise and air quality, have to be improved: the renewal of the interchange will provide new solutions to this old problem (e.g. platforms screens at level “-2”).
3. Long distance services are only offered for destinations to the North-East and to the South- West part of Spain, covering approximately a 30 % of the destinations offered by ALSA (the main company operating in the interchange). Hence new destinations should be offered.
4. Motorised mobility (car traffic) around the interchange should be better managed/organised, especially during peak hours. There is a parking near Avenida de America belonging to the company in charge of the management of the interchange, but there is no collaboration between them.
5. There is a lack of coordination among short and long distance modes.

6.2.5 Current value proposition










<p>Key Partners </p> <ul style="list-style-type: none"> •Long distance bus operators •Regional Transport Authority •Terminal manager 	<p>Key Activities </p> <ul style="list-style-type: none"> •Connecting land transport modes 	<p>Value Proposition </p> <ul style="list-style-type: none"> •Extending the long distance bus services (more destinations) •Parking management collaborating with the interchange needs •Greater Manager role 	<p>Customer Relationships </p> <ul style="list-style-type: none"> • Info-desk •Web- sites 	<p>Customer Segments </p> <ul style="list-style-type: none"> •Low income •Youngers •Bus travellers 	
<p>Key Resources </p> <ul style="list-style-type: none"> •Location: inside city •Connection airport bus 		<p>Channels </p> <ul style="list-style-type: none"> •Web site •Direct selling 			
<p>Cost Structure </p> <ul style="list-style-type: none"> •Operators are focused on minimizing cost (their customers demand it) 			<p>Revenue Streams </p> <ul style="list-style-type: none"> •Bus operators fees •renting space for retail activities •Parking revenues 		

Figure 6.60 Current Value proposition

The new value proposition is based on the need to improve intermodality between the long and the short distance in terms of improving seamless mobility, as proposed in WP2.

6.2.6 Description of current business model

The current Business Model of the Avenida de América interchange is described following the 9 building blocks of Osterwalder approach (WP2). Many of the questions will be answered by means of the interviews/customer survey.

6.2.6.1 Customer Segments (CS)

- How many passengers per day? And per year?

Thirty-six million passengers a year pass through the transport interchange (according to the Terminal Manager).

The number of passengers per day is highly dependent on season and day of week.

- What is the genders' percentage?

According to the surveys male's percentage is 43,1 % and female's 59,9 %

(Note that % are based on the surveys carried out, i.e., maybe the interviewer has found easier to interview women than men, or women could have been more easily addressed).

- What is the passengers' percentage between 0-25, 26-40, 41-60, more than 61 years?

According to the surveys:

Between 0-25 years 13,9 %

Between 26-40 years 51,2 %

Between 41-60 years 24,1 %

More than 60 years 4,7 %

(Please, see the note above regarding gender)

- What is the passengers' percentage with reduced mobility?

2 % according the terminal manager

- What are the passengers' most common destinations?

The airport and any national destination offered by long distance bus service (North- East and South- West part of Spain).

- What is the passenger's travel purpose?

According to the surveys:

For business reasons 17,8 %

For studies 3,7 %

Private reasons 64,3 %

Other 14,2 %

- What class do passengers chose to travel?

Only the long distance bus company, ALSA, offer different travel classes: tourist and business. Notwithstanding, passengers usually chose to travel in tourist class.

Anyway, besides the regular ones, ALSA offers special *Supra* lines for some destinations. Then buses are much more comfortable, seats are more spacious and have more facilities.

These lines are very successful but not as much as regular ones.

6.2.6.2 Value Proposition (VP)

- What kind of transport services does the company offer (e.g. short/long distance, types of transport, etc)?

Long distance services:

- Long distance bus service

-19 lines to different destinations, mainly to the North- East and South- West part of Spain.

Short distance/regional services

- Metro service

-Line 4 (Pinar de Chamartín - Argüelles)

-Line 6 (circular line)

-Line 7 (Hospital de Henares - Pitis)

-Line 9 (Herrera Oria - Arganda del Rey)

- Regional bus service

14 lines to different destinations along the Corredor del Henares (Guadalajara, Alcalá de Henares, Torrejón de Ardoz, etc)

- Urban bus service (EMT)

-9 regular lines

-2 circular lines

-6 night bus services (Búhos)

-Shuttles to Barajas airport

- Taxi service

- What are the different services provided by the company (e.g. combination with other transport modes, ticket for O/D or ticket for service, etc)?

Short distance services:

-Metro: with one ticket, customers are allowed to use any line or combination of line; but once they have left the Metro they must buy another ticket to get on again if so.

-Urban buses: one ticket can be used only for one line and one trip (same price for every line), but from any origin to any destination; there is a ten-trip ticket valid for urban buses and Metro.

-Regional buses: one ticket can be used for one line and one trip, the price varies depending on the line and destination.

A short distance ticket can be used at any time (i.e., it is not for a specific date)

Long distance

-Long distance buses: the ticket is purchased from an origin to a certain destination, and also for a certain day and time of departure, thus it is not valid for other destinations or timetables.

- Do transport services present different travel classes?

Only the long distance bus has two different travel classes: business and tourist.

- Does the provided service allow utilization by people with reduced mobility?

There are ramps in each bus to get on/off, and there are also ramps to access the platforms of buses, so people in wheelchairs can get on urban, regional and long distance buses by themselves.

The problem for them is the access to the Metro lines, because there are no elevators or ramps, although there are escalators.

- What are the main reasons for passengers chose this company over another?

The main reasons are long distance buses and airport connection.

- What are the company's service levels (e.g. reliability, punctuality, etc)?

According to the Terminal manager the level of services is good both in terms or reliability and punctuality. This opinion is based on its own customers' satisfaction survey.

6.2.6.3 Channels (CH)

- What are the channels that the company uses to spread information (e.g. website, displays on platforms, etc)?

Information is provided in website and inside the travel interchange, by monitors on platforms.

There is an information desk available for questions.

- How does the company raise awareness (e.g.: advertisement, etc) about its services?

Through visual information provided at the interchange, as well as its own webpage. Audio advertisements are avoided at interchanges not to bother passengers.

- How does the company sell tickets?

Users can buy long distance buses tickets on the web site, by telephone and at the box office; tickets for urban, regional buses or for Metro are sold at box office ticket sales (Madrid Transport Authority competence).

Taxi trips are paid on-board.

- Does the company provide any after-sales customer support?

Yes, ticket changes and refunds but only for long distance buses.

6.2.6.4 *Customer Relationships (CR)*

- How does the customer interact with the company?

Customers can use the web site, the telephone or box office.

- Fidelity programs (e.g. frequent flyer, etc)?

Yes, Alsa offers the so called "Bus Plus" card; by using it, customers have discounts in tickets and other advantages.

For short distance there are ten-trip tickets (cheaper than ten single tickets), tickets valid for a month, and tourist travel pass, for a certain number of days.

- Does the company have information desks?

Yes, there is one information desk in the Interchange.

- Ticket sells is based on machines or employees?

Both options are available for Metro and all kind of bus services at the interchange.

6.2.6.5 *Revenue Streams (R\$)*

- What are the revenue sources (e.g.: tickets, advertisement, retail)?

According to the Terminal Manager the revenue sources of the Interchange are:

The most important sources are operators that pay for using the interchange.

The second ones are the rental of commercial premises.

The last ones are parking revenues and advertising.

- If there are other revenue sources, how much they represent?

There are no other sources.

- What is the ticketing scheme?

The ticket price does is not a terminal manager's concern; the operators set it.

Operators pay a fee for using the interchange:

-Regional buses: 0,20 € per passenger

-Long distance buses: 6 € per bus

- Does the company have revenue management system?

Not a specific system, as far as the terminal manager knows.

6.2.6.6 *Key Resources (KR)*

- What are the company's financial resources?

N/A.

- What kind of human resources does the company has?

The same as any company (administrative, management staff, etc.)

- What is the company's physical resources

Rented offices inside and outside of the interchange area.

- What is the company's R&D activities (e.g. patents, databases, etc)?

As long as the terminal manager knows, the company does not have that kind of activities.

6.2.6.7 *Key Activities (KA)*

- What are the main activities in the platform/network sector?

To deal with operators, charge them, rent premises, inform travellers, and coordinate all activities that occur in the transport interchange.

- Is the company involved in other activities besides transport?

The terminal manager is an employee of the "Intercambiador de Transportes S.A." which is not involved in other activities than transport.

Otherwise this company owns to IRIDIUM, the concessionary, which has other business lines such as management of highways, airports, car-parking, railways, hospitals, police stations, prisons, water supply networks...

6.2.6.8 *Key Partnerships (KP)*

- Does the company have partners? What sort of partners?

It is a Public Limited Company.

- What kind of agreements does the company have with its partners (e.g. advertising, revenue share, etc)?

The liability of each shareholder is limited to the capital individually invested.

6.2.6.9 *Cost Structure (C\$)*

- Does the company's cost structure is based on minimizing cost for the passengers or focus on value creation (maximising revenue)?

Bus operators are focused on minimizing costs (their customers demand it)

- What kind of economies does the company have (e.g.: scale, density and scope)?

N/A

6.2.7 Current level of quality of services and customer satisfaction

6.2.7.1 Description general information about the passenger

General information about the journey and the passenger has been included in this section.

The journey has been divided into two stages: the first one from origin to the interchange, and the second one from the interchange to the final destination

6.2.7.1.1 Transfer of modes

The surveys were made at the quays of long distance buses, and were answered mainly by passengers who were waiting for the long distance bus (maybe because for them it did not suppose a loss of time to answer to the questions), in fact a 90,76% of the respondents had gone to the interchange to get a long distance bus.

For most of the passengers who were asked, the journey consisted on a short distance trip to the interchange (in which the predominant mode was the Metro), and then a long distance bus trip.

		Avenida de América. Transfer (%)							
		Departs							
		Long distance bus	Short distance bus	Airport bus	Taxi	Car	Metro	Other	
Arrivals	Long distance bus			0,6		1,1	3,9	0,3	5,9
	Short distance bus	3,4							3,4
	Airport bus	5,3							5,3
	Taxi	8,1							8,1
	Car	6,7							6,7
	Metro	67,2		0,8		0,8	1,7		70,6
	Other								
	90,8			1,4		2,0	5,6	0,3	

Figure 6.61 Departures and arrivals

Out of the 90,76 % who were going to depart on a long distance bus, the short distance modes they used were:

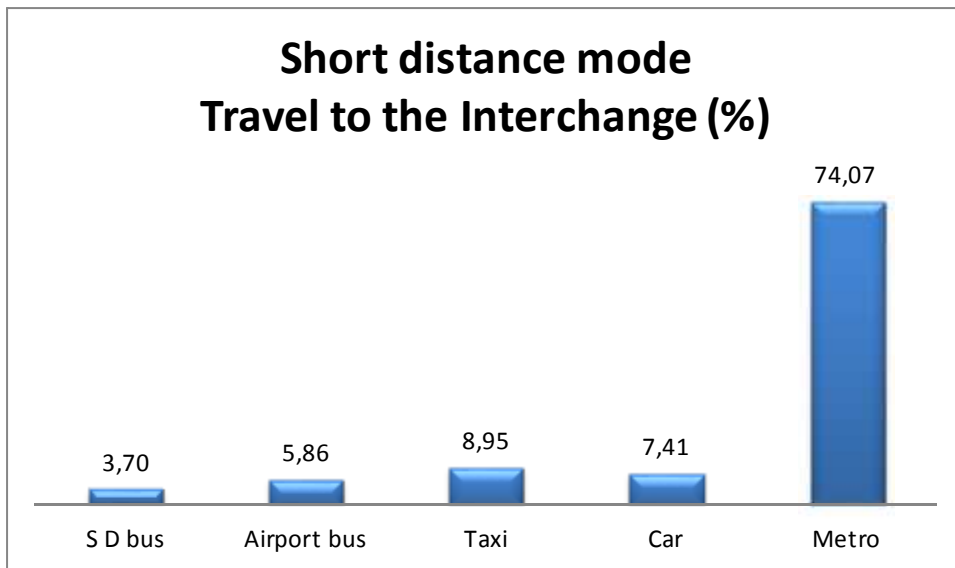


Figure 6.62 Short distance modes

As the graph shows, the other short distance modes are irrelevant compared with the Metro.

6.2.7.1.2 Main mode of transport

Regarding the main mode of transport used in passengers' journey, most of them was the long distance bus (92 %), while for a 7 % was the airplane and for 1 % the long distance train.

6.2.7.1.3 Distance and time

According to this distribution of modes, most passengers' journey consisted on a short distance trip (from 5 to 10 km and from 10 to 30 minutes) and then a long distance trip from the interchange to their destiny (of about 700 km and from 2 to 4 hours).

Distance of the trip	To the interchange (%)	From the interchange (%)
< 1 km	1,1	0,5
5 km	29,8	2,4
10 km	29,5	0,8
100 km	20,1	1,6
700 km	11,5	88,6
> 700 km	8,0	6,0

Figure 6.63 Distance to and from the interchange

Travel time	To the interchange (%)	From the interchange (%)
< 10 min	10,2	1,3
10 - 30 min	48,0	3,2
30 min - 1h	17,3	2,6
1h - 2h	7,3	2,6
2h - 4h	3,9	40,6
> 4 h	13,1	49,6

Figure 6.64 Travel time to and from the interchange

6.2.7.1.4 Passengers' personal characteristics

Personal characteristics passengers were asked for were gender, age and purpose of travel.

Respondents were 44 % male and 56 % female, most of them (51 %) from 21 to 35 years old.

Age (years)	%
15-20	13,9
21-35	51,2
36-55	24,1
56-64	6,0
>64	4,7

Figure 6.65 Age of respondents

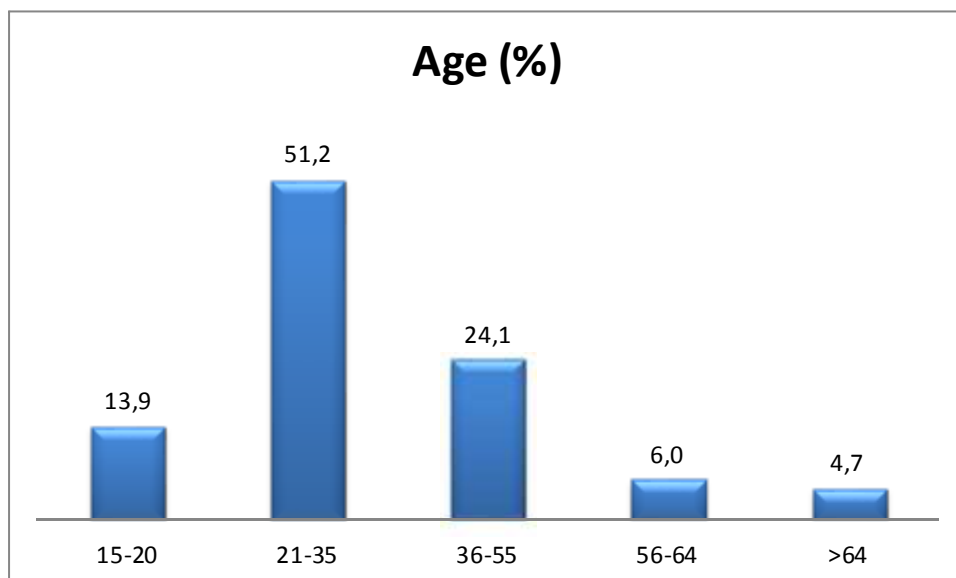


Figure 6.66 Age of passengers.

Passengers travelled mostly because of private reasons (64%) and secondly due to business purposes (18 %)

Purpose of trip	%
Business	17,8
Studies	3,7
Private	64,3
Other	14,2

Figure 6.67 Purpose of trip

6.2.7.2 *Travel demand/Passenger flow*

In this section we try to evaluate if services provided are proportional to the passenger flow, analysing first general aspects as travel supply or main influencers on passengers' decisions, and then aspects related to time and space as quality of services' indicators.

6.2.7.2.1 Travel supply

Regarding opinion about travel supplies, most passengers seemed to be quite satisfied. Out of this, travel connections were the best valued, and the use of waiting time the worst.

	Satisfaction with travel supply (%)				
	Very diss.	Quite diss.	No sat. or diss.	Quite sat.	Very sat.
Coordination Timetables	9,0	13,0	16,0	43,0	19,0
Travel Connections	6,0	12,0	13,0	50,0	19,0
Combine Modes	8,0	14,0	20,0	43,0	15,0
Use Waiting Time	14,0	29,0	24,0	32,0	2,0

Figure 6.68 Satisfaction with travel supply

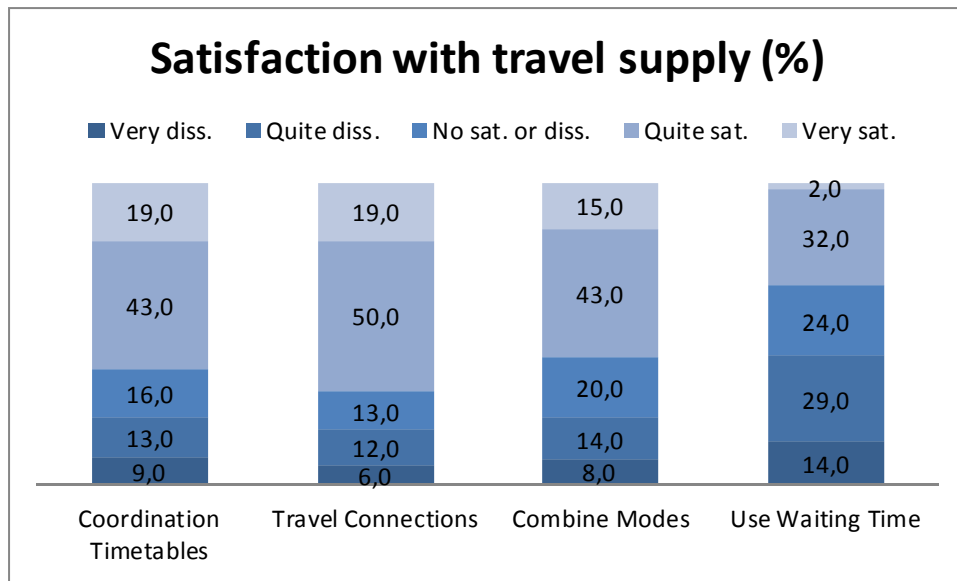


Figure 6.69 Level of satisfaction with travel supply.

6.2.7.2.2 Main factors that influence the passengers choice

The main factors that influenced the passengers' choice were ticket price (47 %) and comfort (16 %). None of the respondents' choice was influenced by services at the interchange.

Influencers	%
Ticket price	47,4
Comfort	16,3
Punctuality	9,6
Environmental reasons	0,8
Total travel time	5,0
Safety/Security	1,4
Simplicity of transfer	4,7
Transport mode services	2,2
Waiting transfer time	0,8
Interchange services	0,0
Other	11,8

Figure 6.70 Influence on passengers' choice

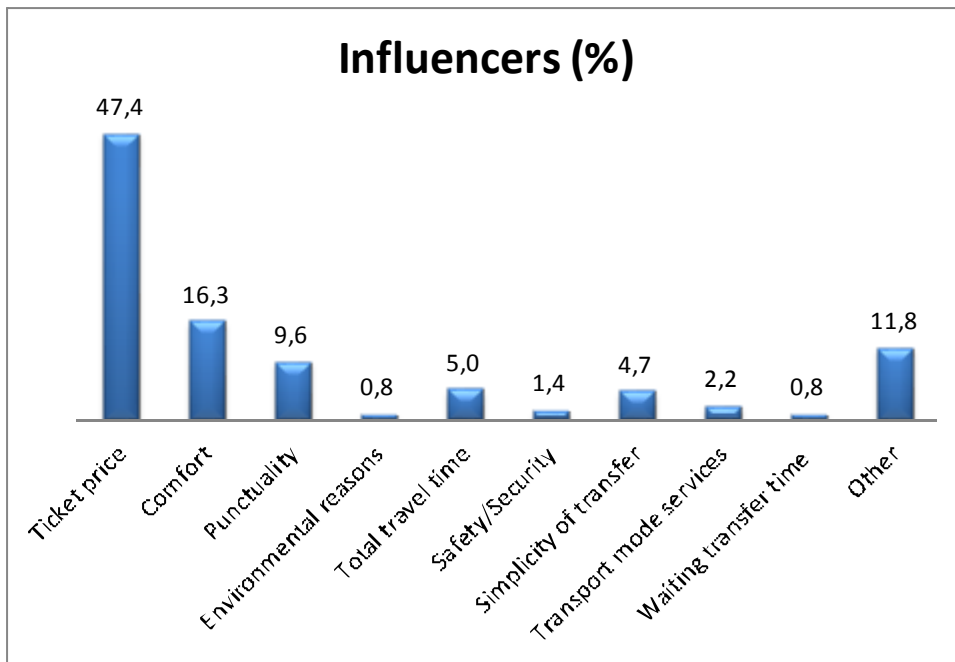


Figure 6.71 Main factors that influenced passengers' choice.

6.2.7.3 Time

In this section time has been considered as an indicator for the quality of the services; and trans-boarding time (total time spent for the passengers at the interchange) has been divided as follows:

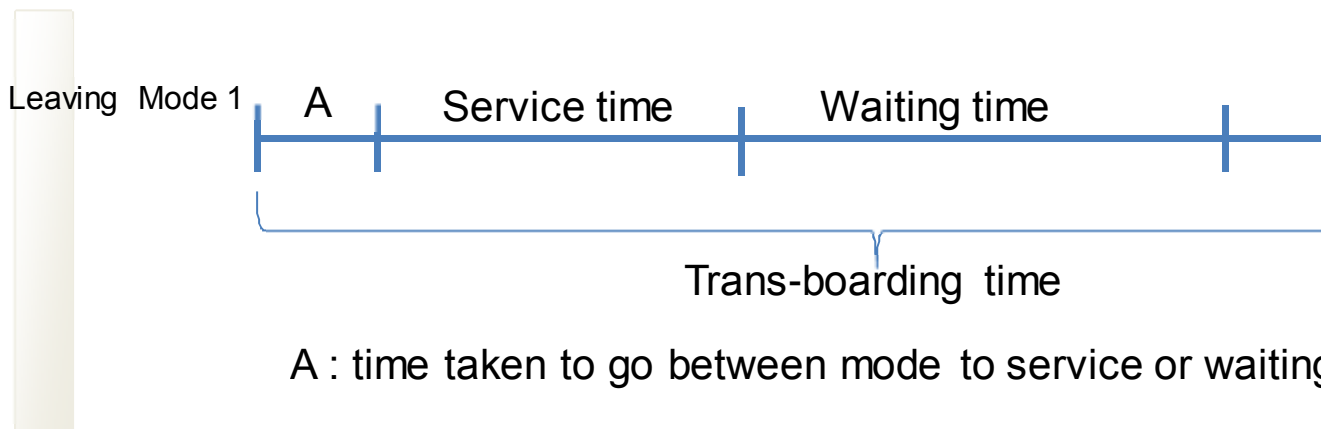


Figure 6.72 Avenida de América interchange. Time division.

6.2.7.3.1 Service time

Passengers were asked about two aspects: time dedicated to baggage and time for disabled to reach different points at the interchange.

Most passengers were quite satisfied with time baggage, but dissatisfied with time for disabled, probably due to the lack or poor quality of facilities such as escalators and elevators.

Satisfaction with service time (%)

	Very diss.	Quite diss.	No sat. or diss.	Quite sat.	Very sat.
Time baggage	4,0	8,0	12,0	53,0	24,0
Time disabled	28,0	22,0	29,0	19,0	3,0

Figure 6.73 Satisfaction with service time

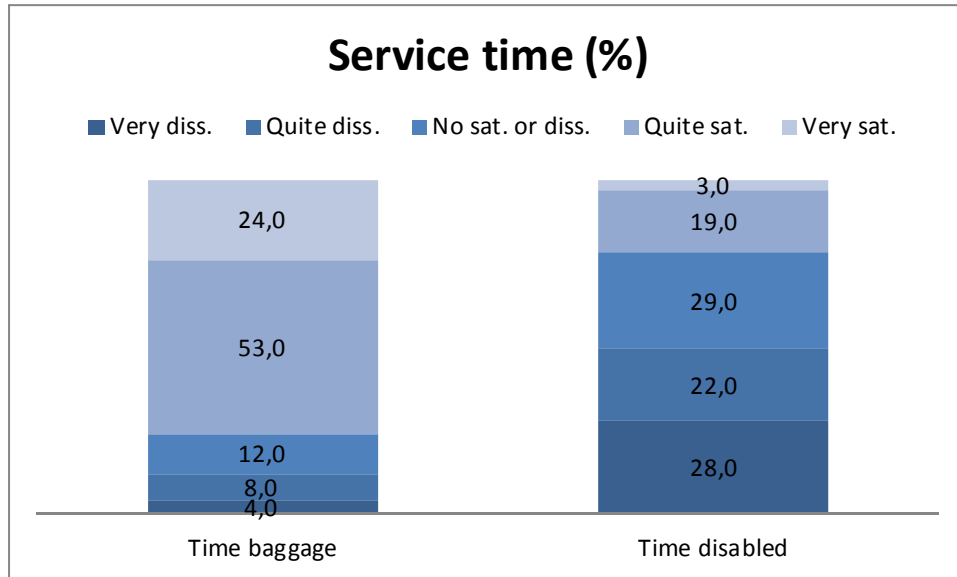


Figure 6.74 Service time.

6.2.7.3.2 Waiting time

Passengers were asked about total waiting time and punctuality.

Most passengers were quite satisfied with these aspects, especially with punctuality (47 %).

	Satisfaction with waiting time (%)				
	Very diss.	Quite diss.	No sat. or diss.	Quite sat.	Very sat.
Punctuality	2,0	3,0	6,0	47,0	43,0
Total waiting time	8,0	16,0	25,0	40,0	12,0

Figure 6.75 Satisfaction with waiting time

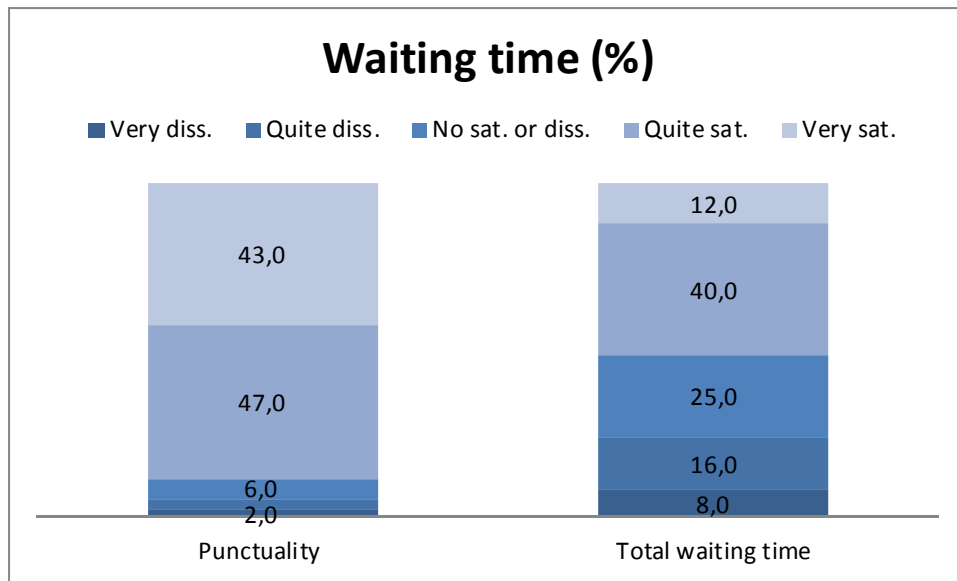


Figure 6.76 Waiting time.

6.2.7.3.3 Trans-boarding time

Trans-boarding time is here understood as the total time spent by the passengers in the interchange. Despite the high level of satisfaction with punctuality and waiting time, most of the respondents spent more than 45 minutes at the interchange (59%), and only 1% due to delays.

Total time	%
< 5 min	2,0
5-15 min	8,0
16-45 min	31,0
> 45 min	59,0

Figure 6.77 Trans-boarding time

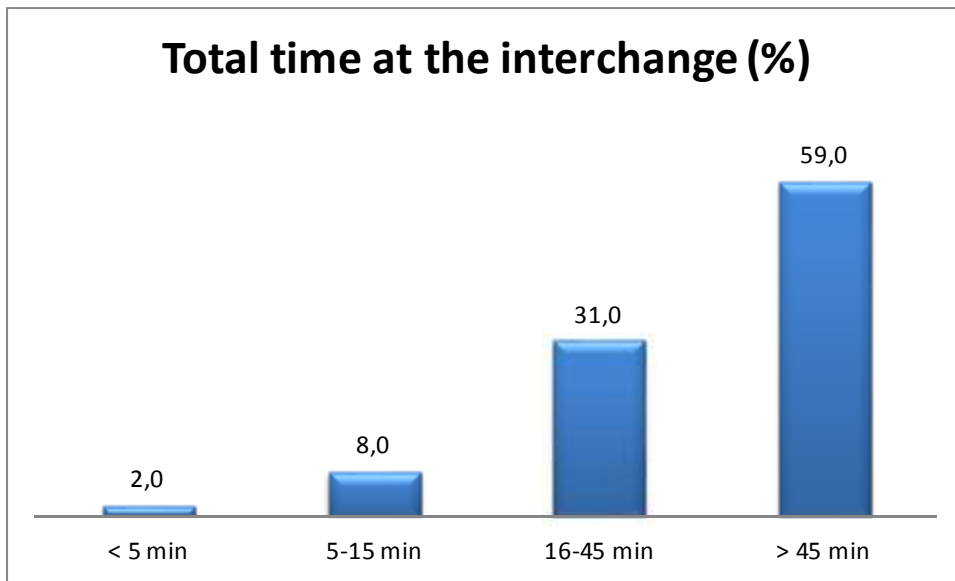


Figure 6.78 Trans-boarding time.

6.2.7.4 Space

In this section space has been considered as an indicator for the quality of the services as follows:

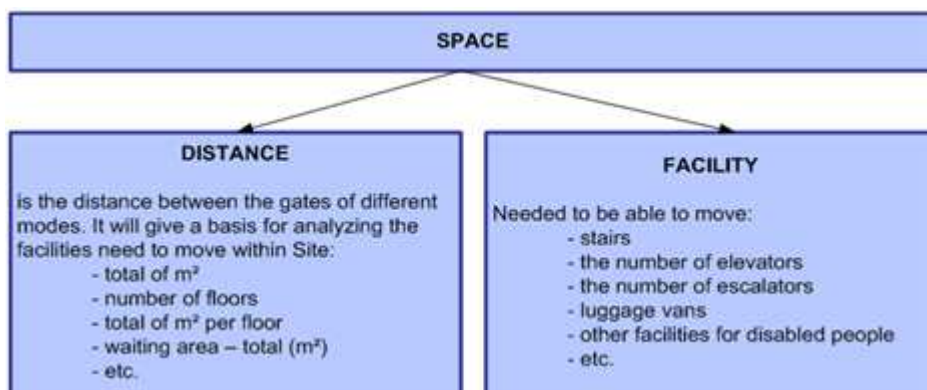


Figure 6.79 Space division.

Regarding space we must evaluate both distance and facilities. Thus, the first questions dealt with how familiar passengers were with the interchange and how easy was to find the next transport mode.

Responses were unanimous: all passengers found very easy to locate their next transport mode, being most of them quite or very familiar with the interchange.

6.2.7.4.1 Passengers familiarity with the interchange

Familiarity	%
Not familiar	11,0
Somewhat familiar	17,0
Quite familiar	41,0
Very familiar	30,0

Figure 6.80 Familiarity

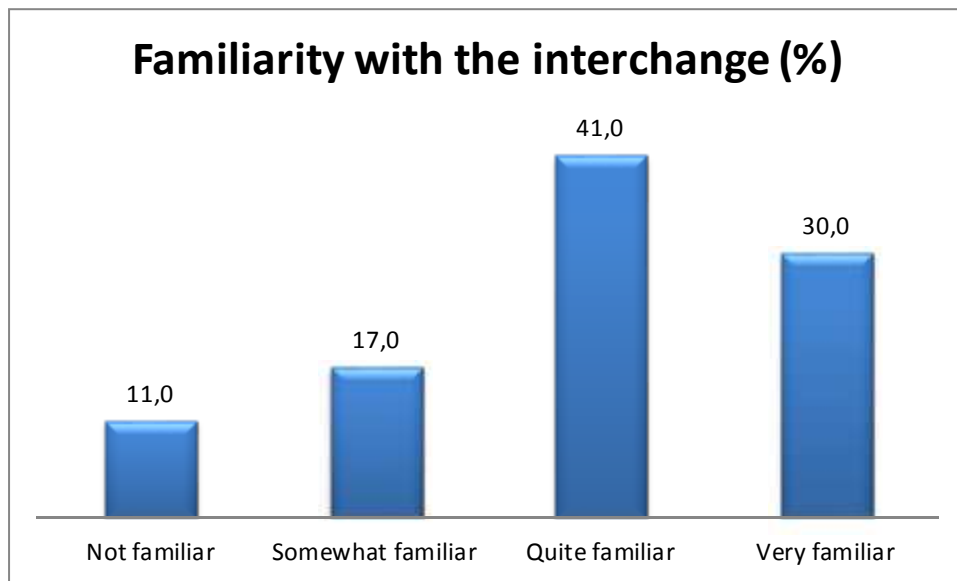


Figure 6.81 Familiarity of the passengers with the interchange.

6.2.7.4.2 Findability of next next transport mode

Easy to find next transport mode?	%
Very hard	0,0
Quite hard	0,0
Neither one	0,0
Quite easy	0,0
Very easy	100,0

Figure 6.82 Findability of next transport mode

6.2.7.4.3 Distance

Three aspects about distance have been evaluated: space at station, seating capacity and access to luggage store.

About space at station and seating capacity most passengers felt quite satisfied (35 % aprox) although there are also a high number who feel quite dissatisfied with both aspects (25 % approx.), so probably they should be improved.

On the other hand very few respondents felt quite or very satisfied about access to the luggage storage, while most of them (51 %) felt indifferent about it, and a high number very or quite dissatisfied.

	Factors about distance (%)				
	Very diss.	Quite diss.	No sat. or diss.	Quite sat.	Very sat.
Space station	9,0	25,0	22,0	36,0	7,0
Seat capacity	16,0	26,0	19,0	34,0	5,0
Acc lugg storage	18,0	12,0	51,0	15,0	4,0

Figure 6.83 Factors about distance

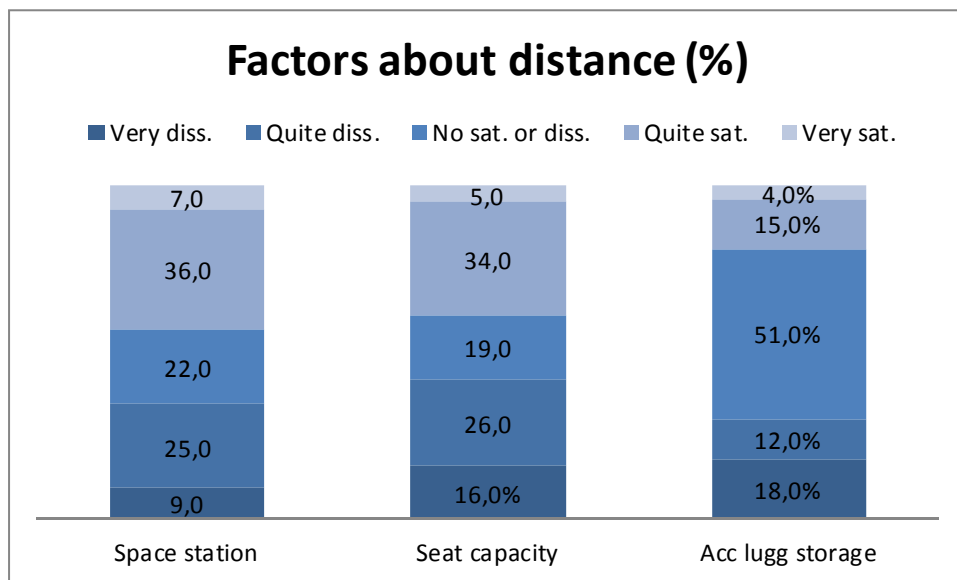


Figure 6.84 Satisfaction with distance aspects.

6.2.7.4.4 Facilities at the site

In this section we analyse facilities by three questions to the passengers: had they missed any facility? ; if yes, what was it?; and finally they were invited to evaluate the main facilities at the interchange, i.e., elevators and escalators.

Only 18 % of the respondents missed any facility at the interchange. Out of them most missed more information or signalling, and secondly more or better escalators and elevators.

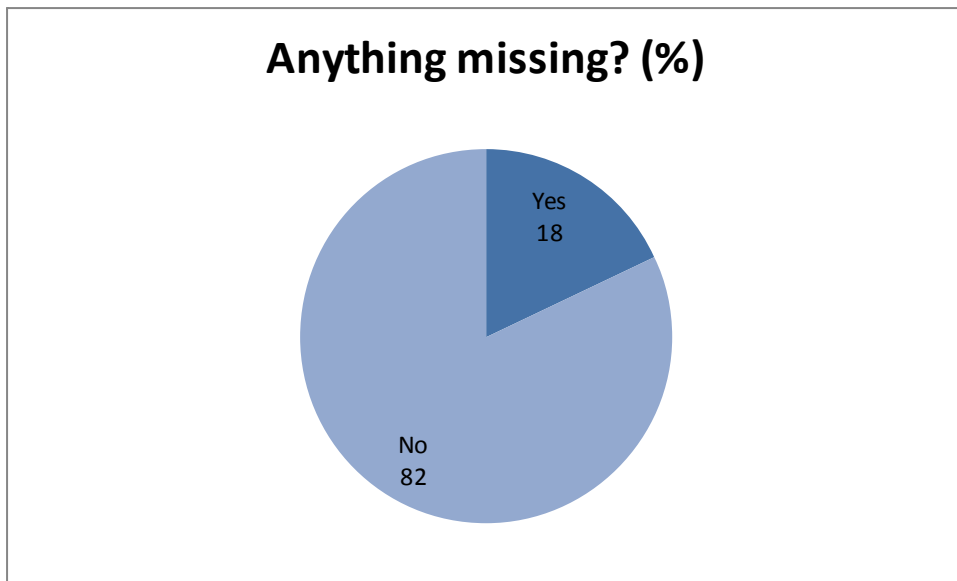


Figure 6.85 Missing facilities.

What are you missing?	%
Signalling/info	56,0
Access/exit gates	5,0
Mode connections	10,0
Elevators/escalators	19,0
Trolleys	3,0
Others	6,0

Figure 6.86 Missing facilities

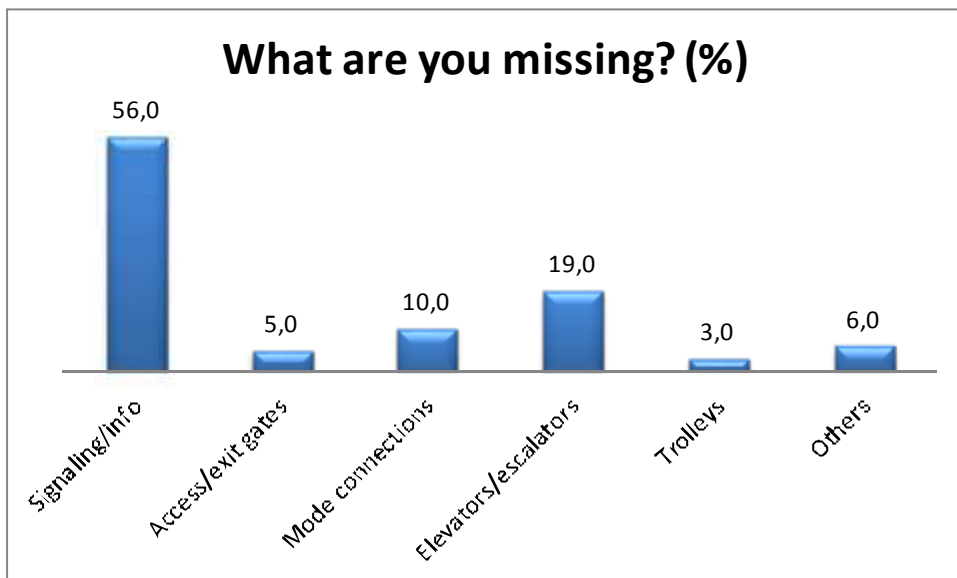


Figure 6.87 Missing facilities.

The main facilities are escalators, used by a **92 %** of the respondents, and elevators used by an 8 %. This is due to the lack of elevators.

Opinions on these two facilities were various, and there is not a clear majority.

Anyway dissatisfaction with escalators seemed to be due to their narrowness, while dissatisfaction with elevators seemed to be due to the lack of them.

	Satisfaction with facilities (%)				
	Very diss.	Quite diss.	No sat. or diss.	Quite sat.	Very sat.
Elevators	26,0	10,0	16,0	26,0	23,0
Escalators	15,0	23,0	16,0	37,0	9,0

Figure 6.88 Satisfaction with facilities

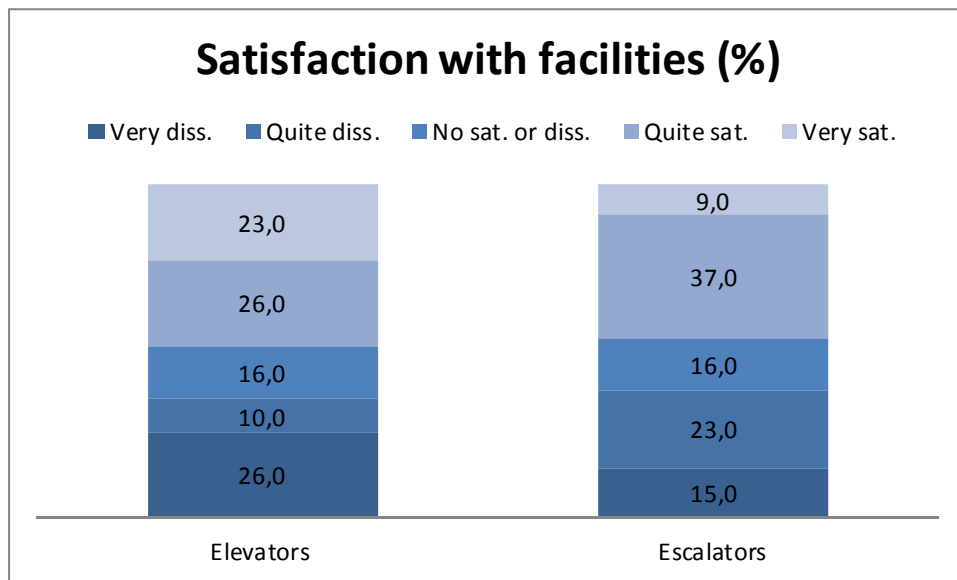


Figure 6.89 Satisfaction with facilities.

6.2.7.5 Information, Ticketing and Check-in Services

Regarding information, ticketing and check-in, passengers were asked to evaluate the existing systems. Most of them feel indifferent but satisfied rather than dissatisfied about these aspects.

Generally the respondents had a better opinion about buying tickets at counters than buying them on tickets machines.

	Satisfaction with information and ticketing systems? (%)				
	Very diss.	Quite diss.	No sat. or diss.	Quite sat.	Very sat.
Information	6,0	7,0	39,0	39,0	9,0
Tickets machine	7,0	9,0	41,0	34,0	9,0
Tickets at counters	4,0	10,0	23,0	47,0	17,0
Counters' personnel	4,0	7,	19,0	51,0	19,0
Reschedule tickets	14,0	8,0	43,0	26,0	10,0

Figure 6.90 Satisfaction with information and ticketing systems

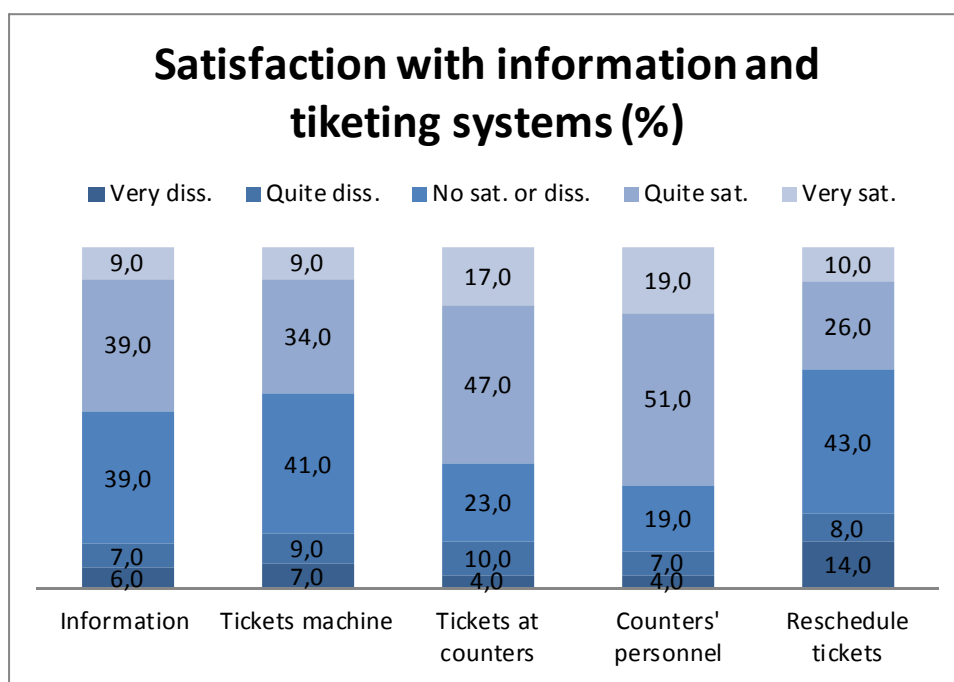


Figure 6.91 Satisfaction with information and ticketing systems.

6.2.7.5.1 Information

The more important aspect about information is if passengers would have liked to receive more information.

Regarding this, most passengers had not noticed a lack of information about the interchange or alternative modes. Out of this there were much more passengers who missed information about alternate modes than those who missed information about alternative modes.

Lack of information?	Yes (%)	No (%)
About the interchange	18,0	82,0
About alternate modes	35,0	65,0

Figure 6.92 Lack of information

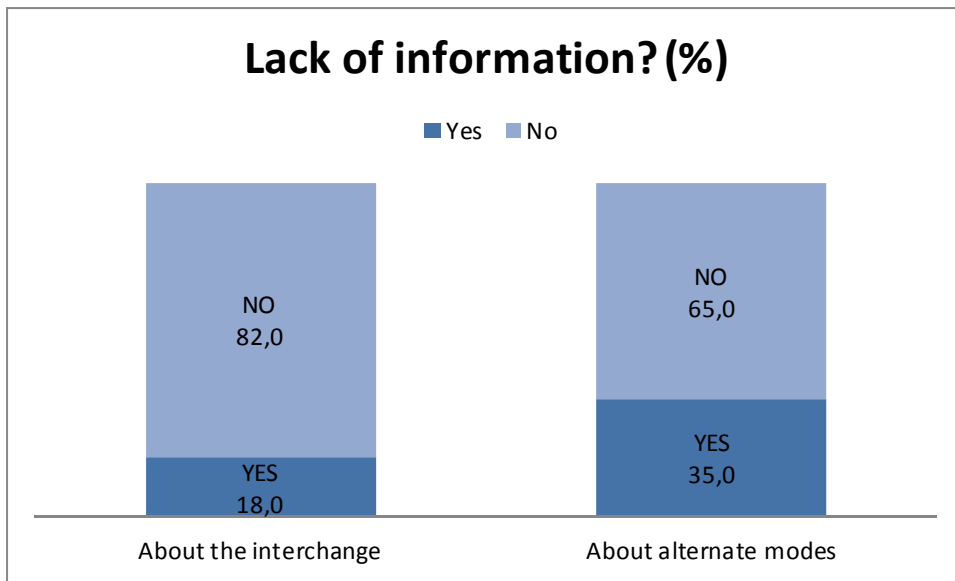


Figure 6.93 Information.

Those passengers who would have liked to receive more information, missed mainly information at the interchange and modes schedules, while few of them missed WIFI

What have you missed?	%
Modes schedule	30,0
Info in the interchange	46,0
Info services	13,0
WIFI	11,0

Figure 6.94 Missed information

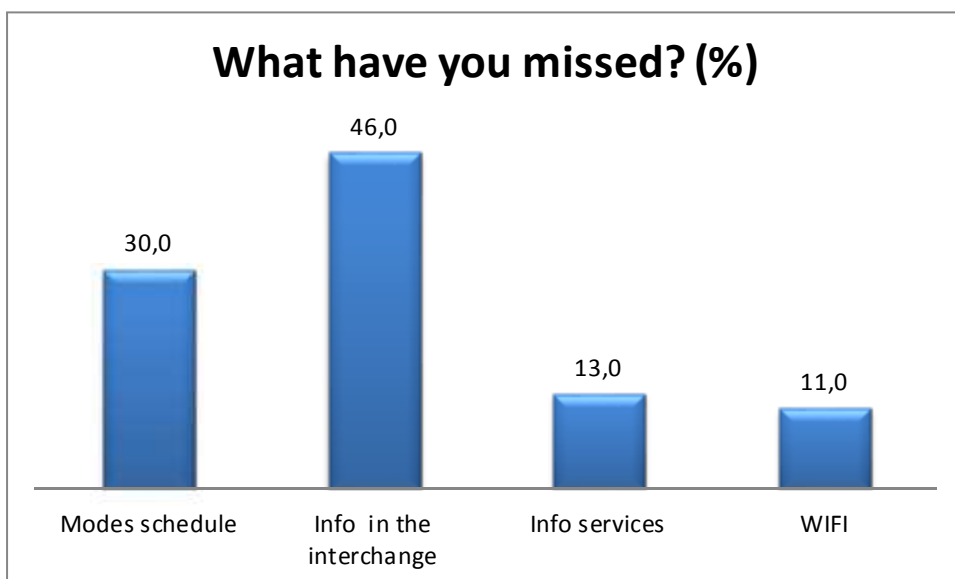


Figure 6.95 Information.

6.2.7.6 Added value at the site

Firstly we asked the passengers to give their opinion of different aspects about added value.

Passengers were quite satisfied with hygiene, toilets and shops as well as with safety and security.

Nevertheless, most of them felt indifferent / rather dissatisfied with services and facilities for disabled; opinions about facilities for disabled and childcare are the worst (30-40 % very dissatisfied).

	Satisfaction with added value (%)				
	Very diss.	Quite diss.	No sat. or diss.	Quite sat.	Very sat.
Shopping	5,0	24,0	31,0	35,0	6,0
Services	11,0	25,0	43,0	19,0	3,0
Access to toilets	4,0	8,0	16,0	62,0	9,0
Cleaning toilets	7,0	22,0	26,0	41,0	4,0
Cleaning station	2,0	14,0	24,0	56,0	4,0
Ventilation	33,0	32,0	17,0	17,0	2,0
Safety/security	5,0	14,0	18,0	52,0	11,0
Disabilities people	24,0	30,0	32,0	14,0	1,0
Childcare	42,0	28,0	27,0	2,0	0,0

Figure 6.96 Satisfaction with added value

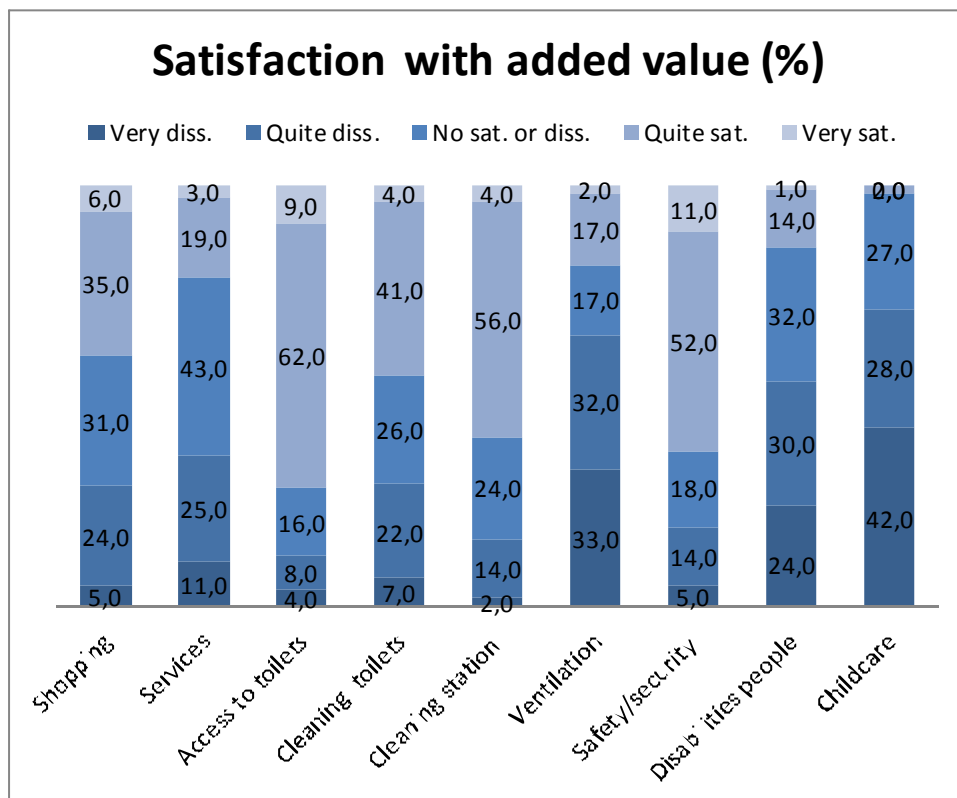


Figure 6.97 Added value.

After giving their opinion, we asked what should be developed to make the interchange more efficient.

Answers were surprising in some aspects such as facilities for disabled or childcare because despite the passengers' bad opinion, very few considered as a priority to improve such a kind of facilities.

On the other hand a high number of respondents said that customer services should be more developed; wi-fi free access was also requested by many passengers.

What should be improved?	%
Services	33,0
Shops	9,0
Disable people	2,0
Childcare	7,0
Luggage store	1,0
More info	14,0
Ventilation	12,0
Wi-fi	20,0
Others	2,0

Figure 6.98 Added value

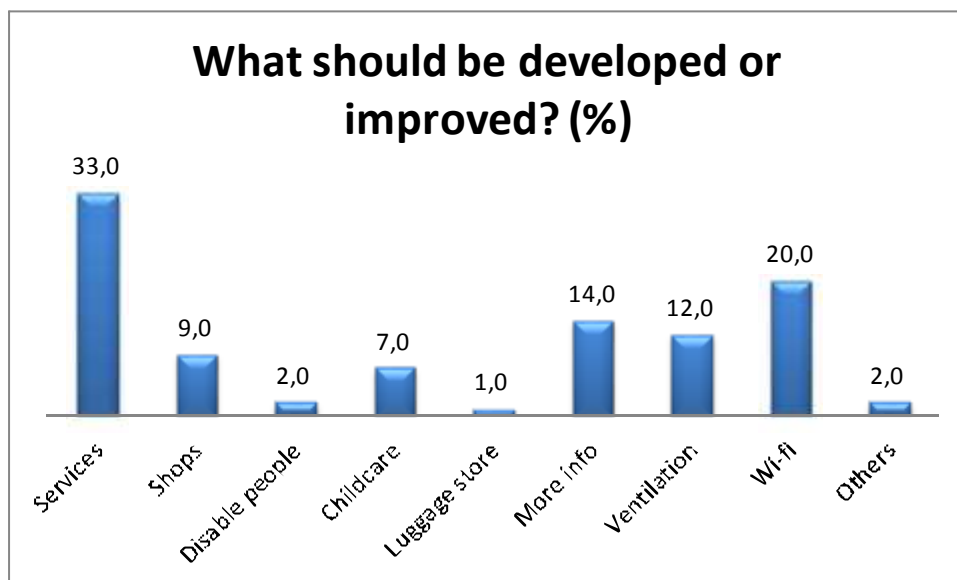


Figure 6.99 Added value.

6.2.8 Analysis for improvement of interconnectivity

6.2.8.1 Comparison between customers and stakeholders

6.2.8.1.1 Travel demand/Passenger flow

Regarding travel demand versus passenger flow both stakeholders and customer groups show a high level of satisfaction (60 % approx).

6.2.8.1.2 Time

Regarding time (punctuality, time baggage and total waiting time) both stakeholders and customer groups are quite satisfied; except for the disabled who are not satisfied at all (this could be because of the lack of facilities and architectural barriers, elevators and escalators mainly)

6.2.8.1.3 Space

Regarding space, the stakeholders group think that it is an old structure without real possibilities of growing, with a high daily passenger flow; therefore they consider that space is an issue to be improved. However, customers are rather satisfied (almost the half) only with space of the station, but not regarding the seating capacity and luggage space.

6.2.8.2 Information, Ticketing and Check-in Services

Regarding this issue customers are rather satisfied (almost 50% satisfied regarding information and 70 % regarding personal at counters), which fits with the opinion of the Terminal Manager at the interchange.

6.2.8.2.1 Added value at the site

In this case stakeholders' opinion coincides with that from customers'. So the main complaints are those regarding ventilation (70 % non satisfied), facilities for disabled (70 % not satisfied) and childcare facilities (70 % non satisfied).

Both groups agree on satisfaction regarding security (60 % satisfied).

6.2.8.3 Validation of findings in WP3/WP4

From all information gathered through WP3 and WP4 (stakeholders' surveys, customers' satisfaction surveys, and "free" questions analysis), it could be stated that there are five key barrier clusters, relevant for all modes and stakeholders

- Need to improve physical infrastructure (it in process)
- Need to cooperation among operators (coordination between short and long distance modes)
- Coordination of different stakeholders

- Coordination of public activities

On the other hand, from the stakeholders' perspective, barriers show specific patterns as follows:

- Public Decision Makers focus the attention on the need for coordination among different stakeholders, particularly among different authorities.
- Terminal Managers focus their attention on the need to foster coordination among operators, particularly regarding scheduling.
- Transport Operators view's regarding as inappropriated the design of the infrastructures (which rapidly collapse because of the congestion), as well as an excesively long winded planning and financing.
- Finally, the User Associations claim for the availability of the intermodal services and information

It is interesting to note that no significant correlation between barrier clusters and mode combinations has been identified.

6.2.8.4 *Missing links and new Value Proposition*

After gathering and analyzing all the information above, according to the Gap analysis carried out by WP2, it could be stated that in Avenida de America interchange an inadequate design of the terminal stations, precluding seamless modal transfer between the long distance and the short distance services, has been identified.

Particular problems for each case of study can be classified into three groups: bad information or signaling, lack of physical integration and non adequate relationships between agents.

In short, the gap analysis carried out in the analytical process

(WP2-WP5) in Avenida de América has identified a bad intermodal transfer in the following terms:

6.2.8.4.1 Bad information or signaling:

- According to the surveys a 18 % of the respondents would have liked to receive more information about the interchange and a 35 % about alternative modes. On the other hand there are more complaints about signalling and information than about escalators or access. So this is a issue to improve.

6.2.8.4.2 Lack of physical integration:

- Lack of elevators and bad design of the escalators (currently under revamping). According to the surveys a 20 % of the respondents were missing elevators or escalators.

- Insufficient number of quays (which does not allow operators to offer other destinations). Buses only go to the North- East and South- West part of Spain.
- Buses find problems of congestion and no place available to park.
- Bad organisation of motorised mobility around the interchange. There is no place for cars to drop travellers (kiss and ride).

6.2.8.4.3 Non adequate relationships between agents.

- There is a lack of coordination among different stakeholders particularly between Transport Operators, which is translated in a lack of coordination among short and long distance modes
- Decision Makers are not conscious of the particular problems of the Interchange.
- Terminal manager who is very close to users' opinions and complaints about the interchange cannot make decisions.

So, the new value proposition is based on the need to improve intermodality between the long and the short distance in terms of improving seamless mobility.

6.2.9 Actions for improvement of interconnectivity

6.2.9.1 *Proposal*

In general terms from the analysis carried out through the different surveys, to overcome the barriers existing in the current model, different actions should be needed. In this paragraph we will describe feasible actions to overcome barriers and to improve the intermodal transport service, presenting and justifying a new proposal.

6.2.9.1.1 Information and signaling

- There should be a **real- time info display**.
- The interchange should have a **web site** to provide **information** about schedules and time tables regarding all **modes** inside the interchange (regardless long or short distance, competencies, etc.)
- We propose agreements between long and short distance operators to provide **information about metro and short distance buses** (maps or schedules) **with long distance bus tickets. When acquiring long distance bus tickets.**

6.2.9.1.2 Physical Integration

- Escalators and elevators are being currently improved.
- We propose an **extension of the geographical coverage**; if **long distance destinations other than current** were offered by operators, more passengers would use the interchange, profiting of its good location and connections.

We propose the Terminal Manager **to manage together long distance and short distance bus spaces**, which would allow to adequate the use of quays to the passengers' demand.

A possible solution could be to substitute some short distance bus quays for long distance ones. According to the surveys, only a 4 % out of the 90 % of passengers departing on a long distance bus uses a short distance one, while a 74 % uses the metro. Nevertheless the floor level -1 is dedicated to long distance buses and level -2 to short distance buses.

- The parking near the interchange is owned by the concessionary Avenida de America S.A, but works on an independent basis. Our proposal is a **joint parking management according to the interchange needs**.

In this respect there are two possibilities that should improve the service:

- **Space for bus parking.** Buses could stop or wait there.
This would also mean more frequencies and less congestion and, therefore, less waiting time and less noise and pollution.
- **Drop off parking (K&R).**
Space reserved to *kiss and ride* (K&R) passengers, even free. This would make easier arriving by car to the interchange.

6.2.9.1.3 Relationships between agents

- Our proposal is to **transfer certain tasks from the Decision Makers to the Terminal Manager** (since he is closer to the users than the rest of stakeholders).

That is why he should make some decisions, and he should undertake some aspects regarding all modes and operators.

So, the relationships between stakeholders should be this way:

- Terminal manager acting independently from Transport Operators
- Decision Makers delegating some decisions to the Terminal Manager (those affecting transfers into the interchange or station)
- Not only transport operators should be responsible for the service provided to users, but also the Terminal Manager, since users highly value the whole journey where the transfer is very relevant.

There should be a better coordination between through a continuous dialogue and formal agreements.

Obviously, a better management of the existing resources (fleet and timetables mainly), together with new investment in services (to maximize information and comfort) will benefit all agents, who will increase social and economic benefit through a higher use of public transport.

6.2.9.2 *Description of proposed service using the concept of Agents*

6.2.9.2.1 Agents

6.2.9.2.2 Objectives and Goals

a) Decision Makers

As surveys have evidenced the main objectives of the Avenida de América interchange decision makers' are focused on fostering the use of public transport by improving intermodality. To do so, and due to their own competencies, DM (Madrid Transport Authority) could influence on a better coordination between agents (operators and Terminal Managers). And should delegate some functions in the Terminal Manager.

b) Terminal managers

Terminal managers objectives are focused on facilitate the interchanges, mainly in terms of reducing waiting time for both users and buses.

Integration of ticketing and tariff system –as other main concern, not to say barrier- could be achieved by a better coordination with operators and DM.

c) Operators

At AA interchange operate public companies, it could be stated that the main focus of these last is on reducing costs, long distance bus operators are also focused on reducing costs, because their customers demand it.

d) Users

Users' objectives regards mainly to minimize costs and transfer time and to maximize comfort.

6.2.9.2.3 Strategies

In this paragraph we deal with the possible actions that each one of the described agents can take to achieve its objectives, through feasible and realistic actions.

a) Decision Makers

To ease certain market rigidities through improvements in the concessional framework.

This means new concessional schemes with a greater room for private participation and initiatives. For instance, an extension of the concession period in exchange for new investment.

b) Terminal managers

The terminal manager at AA interchange is a private company (the one who entitles the concession). So, to achieve the company's goals it is needed a better coordination with operators in scheduling, in order to get the more efficient use of docks

c) Operators

Pricing policy (following the flight companies' schemes: different prices according booking time, for instance).

Better information (advertising, web, use of social networks, etc).

d) Users

Available and updated website

6.2.9.2.4 Interactions between agents and graphical representation

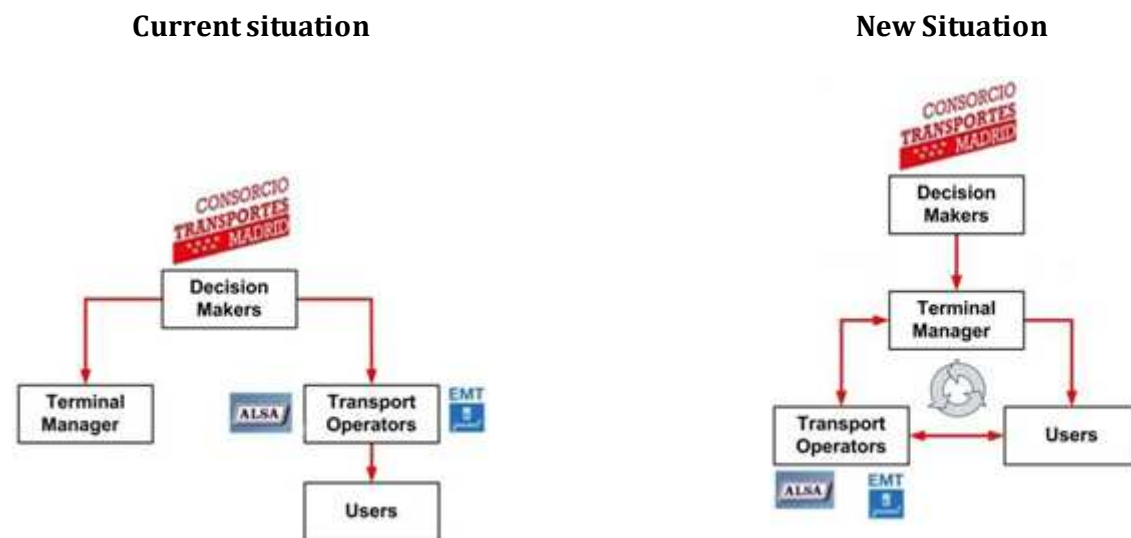


Figure 6.100 Interactions between agents current and new situation

6.2.9.2.4.1 **New situation:**

- 1 **Transport Authority (Decision Maker)** is responsible for appointing **Terminal Manager**.
- 2 **Transport Authority** delegates some decisions to the **Terminal Manager**.
- 3 **Terminal Manager** coordinates public and private **Transport Operators**.
- 4 **Terminal Manager** manages the interchange, defines contract agreements and controls that **Transport Operators** respect regulations.
- 5 **Transport Operators** pay operating fees for using the infrastructure.
- 6 **Transport Operators** and **Terminal Manager** are both responsible for providing service to **users**.

6.2.9.3 *Functions and Indicators to show enhancement*

6.2.9.3.1 Functions of validation

6.2.9.3.2 Information and signaling

The lack of information makes people spending more time at the interchange looking for the next transport mode, and also makes some travelers going by taxi or by car, more comfortable but more expensive, but do not require knowledge about schedules, combinations or maps.

Therefore an improvement on the information and signaling at the interchange would reduce the time spent at the Interchange and would induce some passengers getting there by public transport modes, hence saving money.

6.2.9.3.3 Physical integration

The inside city location and the high number of metro connections into the interchange make Avenida de America the preferred one for long distance bus travelers and, therefore, for operators.

Avenida de America is, in fact, the Madrid interchange with more passengers a year (and for sure this is not because of the size). Indeed, according to the Terminal Manager, Operators demand more quays and the existing ones are saturated.

For this reason it is assumed that an extension in the number of quays would allow operators offering more destinations and more passengers would take advantage.

On the other hand, short distance buses are used by a reduced number of passengers (because of the wide coverage and the reliability of the metro lines). So a possible solution could be to substitute some short distance bus quays by long distance ones.

Another physical barrier is the lack of parking space for buses, which creates congestion inside the Interchange, with effects on bus frequencies, noise, emissions and temperature conditions (more than 50 % of users complain about ventilation).

Then, if the parking near the interchange would allow places for buses to park, frequencies could be higher, improving the transport service; and the waiting area would also be more comfortable because of the reduction of noise and pollution.

The traffic around the interchange is poorly organized, with no place to stop and drop travelers arriving by car. Despite of this an 8 % of travelers arrive by car, which allows concluding that creating some places to drop off users (K&R) would increase their level of satisfaction. On the other hand, many former taxi users could get the interchange also by car saving money, former short distance bus users could arrive by car saving time, and the number of travelers using the Interchange could increase.

6.2.9.3.4 Relationships between agents

Currently the Terminal Manager is not fully responsible for the interchange. For instance, he cannot make decisions about issues affecting intermodality since he does not manage and has no competences at all on short distance modes.

Despite of it, stakeholders' and customer's surveys show that the Terminal Manager is the closest one to the customers' complaints and suggestions, so it could be assumed that allowing him to make some decisions should make improvement actions more effective.

6.2.9.3.5 Indicators of validation

PROPOSALS		INDICATORS	RESULTS ON INDICATORS	POTENTIAL DEMAND
Information and signaling	Real-time information display Web site with information about metro and short distance modes Information about metro and short distance bus altogether provided with long distance modes ticket	Time spent at the Interchange	Reduction	Mostly passengers from outside Madrid Mostly passengers arriving by taxi or car
		Percentage of passengers travelling on public transport modes	Increase	
		Money spent in the whole trip	Reduction	
Physical integration	Extension of the geographical coverage (by increasing the number of quays, managing together long and short distance bus spaces)	Number of users (passengers/year)	Increase	New Passengers from other destinations than nowadays offered
		More space for bus parking (joint parking management according to the interchange needs)	Waiting time (in min.)	
	Drop off parking (joint parking management according to the interchange needs)	Noise (decibels) in the waiting area	Reduction	All
		Air pollution at the waiting area	Reduction	
		Level of congestion around the interchange	Reduction	
Level of pollution around the Interchange	Reduction			
Relationships between agents	Decision Makers delegating a number of tasks to the Terminal Manager	Number of meetings per year between Terminal manager and decision makers	Increase	All

		Number of initiatives understood as improvement actions, started by the terminal Manager	Increase	
	Terminal manager more competencies in providing service to users	Number of surveys, quality test or flow measures carried out by the concessionary	Increase (currently non existing)	
		Number (and quality) of new communication channels between the concessionary and the users.	Increase	

6.2.9.3.6 Methods and tools

There should be a quality survey among passengers carried out by the concessionary under the responsibility of the Terminal Manager. With the information collected, statistics about some relevant issues should be produced to evaluate if improvements and changes are working as expected.

Indicators calculated by these surveys and statistics could be:

Total time spent at the interchange, and **waiting time**

Percentage of passengers using each mode from those offered at the interchange

Money spent in travelling by passengers

Indeed, the frequency in carrying out these surveys is an indicator by itself:

Number of surveys or quality test per year

This indicator gives an idea to the Terminal Manager about the need for improvement the services provided to users. They should be done at least once a year.

Flow measures should be calculated at the Interchange, also under the responsibility of the Terminal Manager. Nowadays CRTM, the Regional Transport Authority carries out a manual counting of the passenger flows, but only for public transport modes, and not focused on transfers at the Interchange.

These flow measures would allow calculating:

Number of passengers per year using the interchange

Percentage of passengers using each mode from those offered at the interchange

Comfort at the waiting area should be evaluated. Passengers spent most of the time at the Interchange waiting for long distance buses (level -1, at bus quays), so facilities are needed to measure:

Noise (**decibels**)

Air contamination (**emissions**)

Temperature

We could evaluate relationships between stakeholders by means of surveys among the Terminal Manager, Decision Makers and Managers of the transport operators companies, asking about:

Number of meetings per year between Decision Makers and Terminal Manager

Improvement actions or decisions undertaken by the Terminal Manager and **relevance** of them.

Number and quality of new channels of communication (interaction between users and the concessionary in charge of the Interchange, channels for consumer's complaints or proposals)

6.2.9.4 *Demonstration and Evidence of Improvement*

Improvement actions should be translated into the following results:

- Flow measures should yield a major number of passengers per year using the Interchange, mainly because of the increase of long distance bus destinations offered by operators, and secondly because of the improvements in access modes (information and kiss and ride parking)
- The distribution of passengers between short distance modes would change: more passengers would use the metro because of the better information; more passengers would arrive by car using the K&R, and maybe fewer passengers would use short distance bus and taxi.
- Facilities installed to measure comfort at waiting areas should yield less emissions and decibels as well as improve the temperature conditions, because of the reduction of bus congestion due to the new parking spaces. Surveys among the passengers should demonstrate also an increase in the user's satisfaction levels.
- Passengers should spend less time at the interchange and save money in the whole trip since it would be easier to access public transport modes due to the improvement of the information provided.
- The Terminal Manager should undertake more decisions, assume more competencies and collaborate with Decision Makers in a more direct manner; they should hold meetings as frequently as possible. The Terminal Manager should also attend to all operators' needs and requirements, to provide a good service to users.

All decisions and improvements should be translated into more satisfied users, and surveys should allow checking it.

6.3 Zaragoza – Lleida, Spain

In Zaragoza there is a railway station, Zaragoza is the main city of the Region of Aragón. In Lleida there is a railway station, Lleida is a city in the Catalan Region.

Both transport interchanges are located in the north-east of Spain and in a strategic position since they are in the heart of the ring defined by 4 of the main Spanish cities: Madrid, Barcelona, Valencia and Bilbao.

The closeness to the French border provides this case study an interesting connotation: real/potential international long/short distance intermodality can be explored and analysed. It is worth noting that both cities are also closed to the Pyrenees, where many of Spain's best ski resorts are located (→ touristic flows).



Figure 6.101 Location of Zaragoza and Lleida in the Iberian peninsula

Zaragoza

Zaragoza, in the middle point between Madrid (312 km) and Barcelona (286 km), has 701.090 inhabitants (01.09.2010) and is situated on the river Ebro. Zaragoza railway station was built for the arrival of the high-speed train (AVE). The interchange is far from the city center and this caused critiques by the local government when it was constructed. The central bus station is located inside the railway station, providing intermodal interconnections among bus and rail modes.

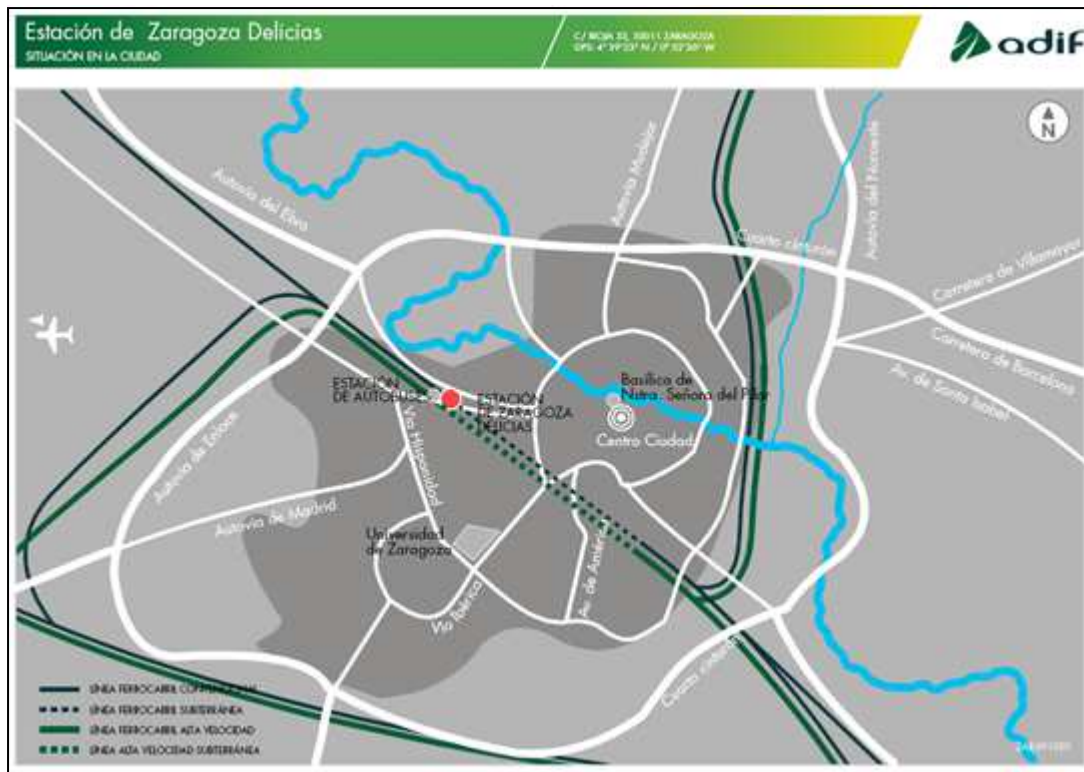


Figure 6.102 Location of Zaragoza Interchange



Figure 6.103 Zaragoza Interchange and its surroundings



Figure 6.104 Zaragoza Intercange. Exterior



Figure 6.105 Zaragoza Interchange: exterior and interior. Buses



Figure 6.106 Zaragoza Interchange: exterior and interior. Trains

Lleida

Lleida has a population of 138.796 inhabitants (31.12.2009) and connects the inner Spanish region with the big cities of the Mediterranean Corridor and the French border. Lleida railway station is located in the north of the city, close to the river Segre. The central bus station is 1.7

km south to the railway station, located in a commercial street where traffic flows are quite intense.

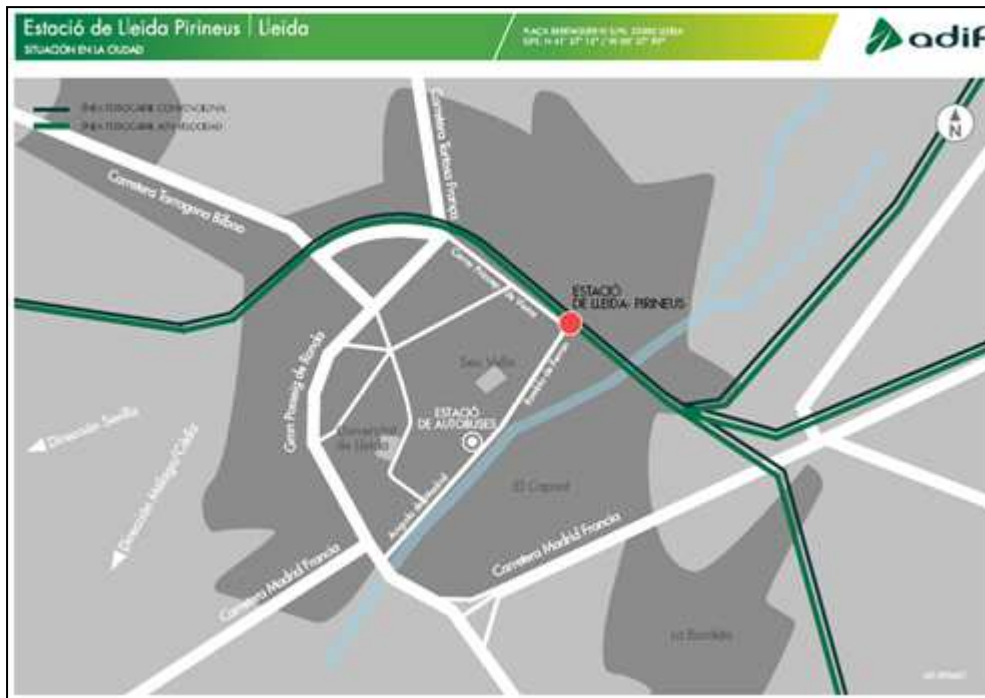


Figure 6.107 Location of Lleida Interchange.

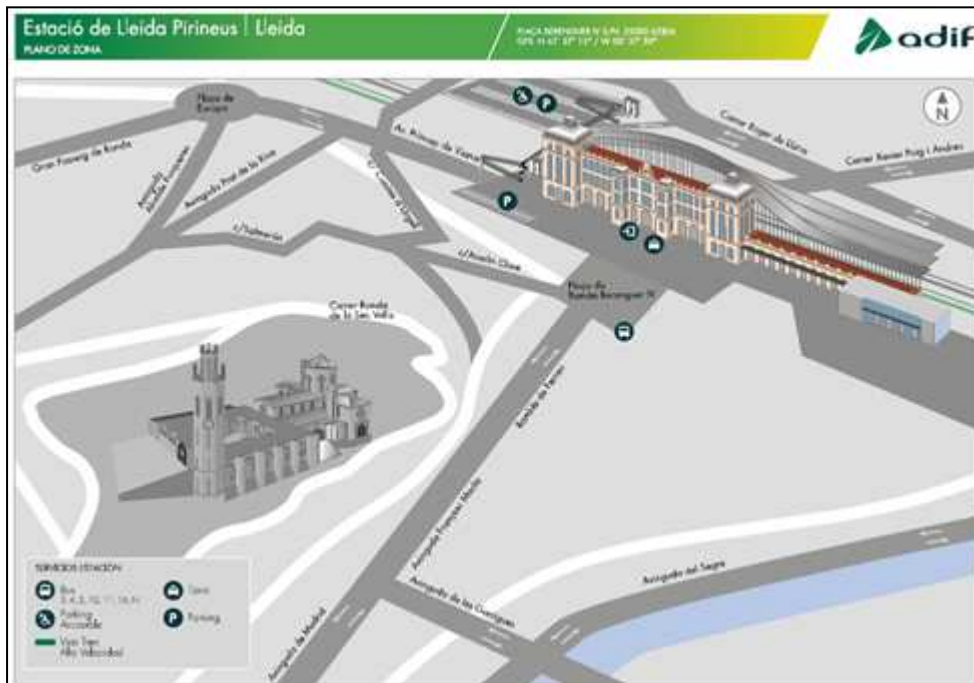


Figure 6.108 Lleida Interchange and its surroundings.



Figure 6.109 Lleida Interchange: exterior and interior

6.3.1 Main features of the site

6.3.1.1 Zaragoza

The building of Zaragoza interchange, which was opened in 2003 and has a surface area of 190.000 m², is one of the best examples of town planning transformation.

The station's roof is characterised by a metal structure formed by nine arcs which support a large surface folded in triangular shapes and perforated by numerous skylights allowing the passage of natural light. This creates a suggestive play of interior lights in the large open-plan space of the platform area.

The railway station has eight rail platforms, which are about 400 meters long, offering high-speed (international gauge) and conventional rail passenger service lines. Below the platforms there is a transfer, which connects them with the parking lots, the taxis, the urban bus stops and the bus station.

As regards the parking facilities, there are two external areas with 1449 (north) and 351 (south) places available to park, as well as underground parking lots. Outside the interchange a cycle storage has also been located, improving intermodality with soft modes.

The railway station has two independent lobbies, one for departures and another for passenger arrivals. The departure lobby is provided with the following services: retails (tobacconist, shops), travel agency, police station, customer assistance, toilets, ticket office, left-luggage office, ticket vending machines, cash machines, restaurant/café, air-conditioned waiting areas, AVE club room, etc. The arrivals lobby is provided with the following services: hotel, car rental services, toilets, café, tourist information, etc.

The station has a good accessibility thanks to four automatic doors that lead to the interior of the station. Passengers can access/egress to/from the railway platforms through stairs, mechanical ramps and lifts, which have been adapted for mobility impaired passengers too.

The central bus station is physically integrated in the building, since it is located next to the hotel of the station within the interchange complex. It only provides interurban and long distance bus service (national and international) and it is characterised by 46 bus platforms. Cafes and shops are available too and the access is possible from the railway station, the transfer and an external walkway too.

Real-time information systems have been implemented to manage bus and rail service operational issues, but separately: the systems are not integrated. Anyway, although this lack of coordination, directions to the bus station are provided throughout the railway station and a certain homogeneity can be observed within the railway station.

Integrated ticketing, special and/or cross-border tickets have not been implemented to enhance long-/ short distance intermodality at the interchange.

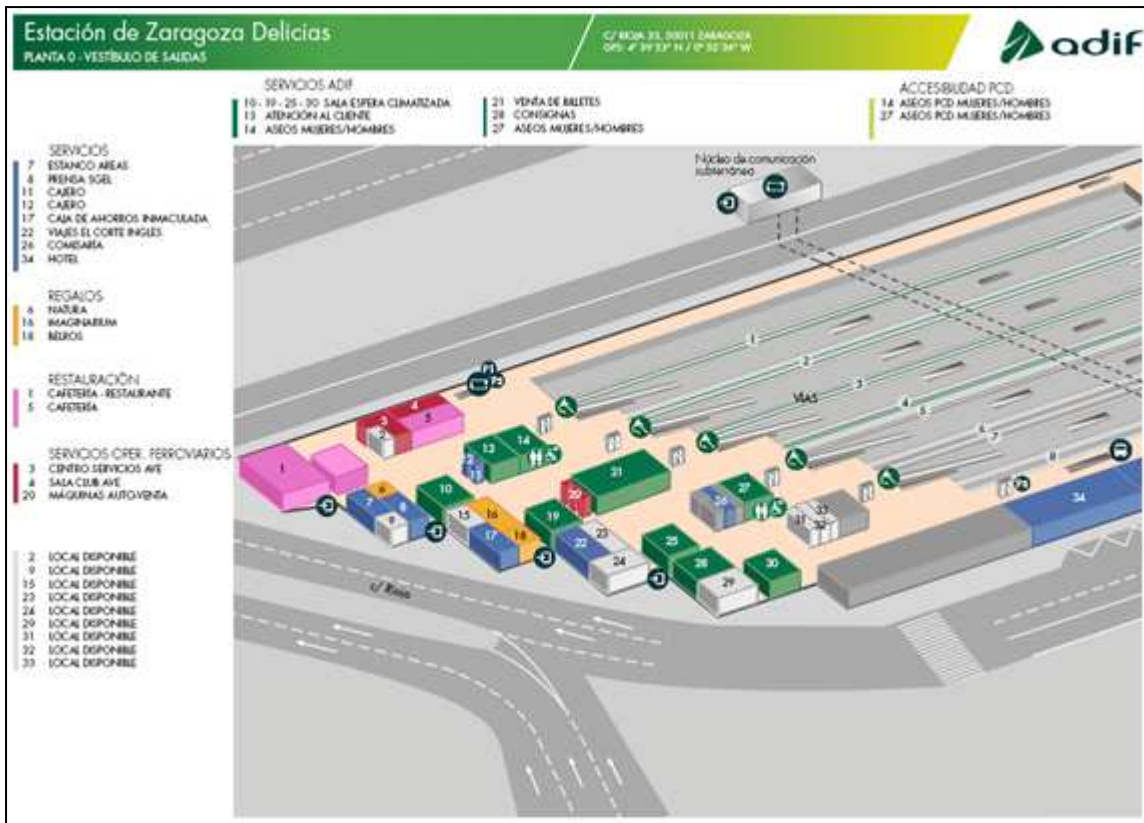


Figure 6.110 Services at Zaragoza Interchange(I)

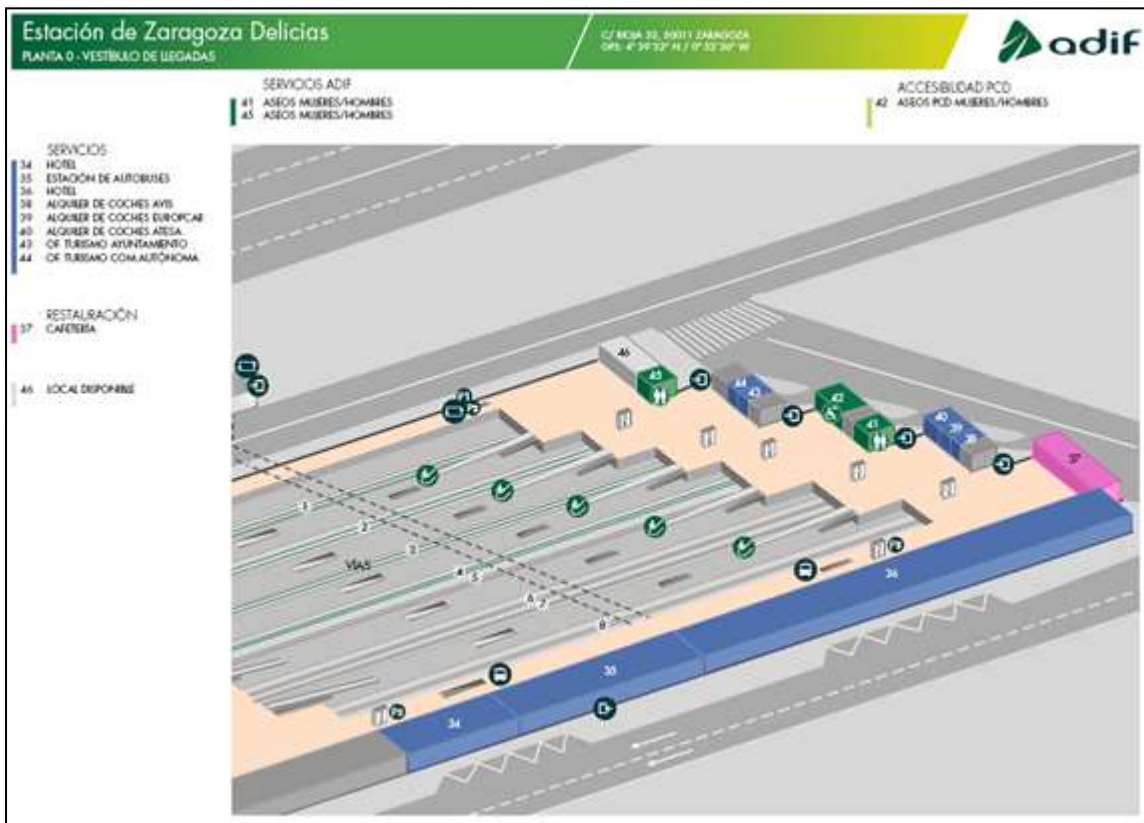


Figure 6.111 Services at Zaragoza Interchange (II)



Figure 6.112 Zaragoza Interchange: lobby for departures



Figure 6.113 Zaragoza Interchange: lobby for arrivals



Figure 6.114 Zaragoza Interchange: Accessibility



Figure 6.115 Zaragoza Interchange: accessibility



Figure 6.116 Zaragoza Interchange: information

6.3.1.2 Lleida

Lleida railway station underwent an important refurbishment and expansion to adapt it to high speed requirements (1999-2001). The most visible of the works carried out is the installation of a canopy, based on steel and aluminium, formed by three waves positioned over platforms and four throughout 200 metres of the passenger building.

The wide space in front of the station has been renewed during the last five years: taxi lots and kiss&ride facilities have been organised. All the physical space was designed taking into account passengers' needs and the customers' point of view.

Through a lobby passengers can underpass the building reaching the rail platforms. Several measures have been implemented too, in order to improve disabled people mobility (e.g.: wheelchairs accesses, adapted furniture, etc).

The station provides several additional services for passengers: retails (tobacconist, bookshops), customer assistance, station market, toilets, ticket offices, left-luggage office, ticket vending machines, cash machines, café, hotel, car rental services, AVE club room, etc. In the upcoming

years a shopping centre will be constructed next to the station, providing additional services for passengers and not only.

There are two rail operators in the interchange: Renfe Operadora and the Ferrocarrils de la Generalitat de Catalunya. Ticket offices are separated and both specific and common signage is provided throughout the interchange.

Actually, the station of Lleida is not an interchange, since the bus central station is located 1,7 km away. Only urban bus service and taxis are provided. Some regional buses at station have introduced a second stop near the train station. However, the new bus station of the city will be constructed next to the railway station, together with other 600 parking lots. The aim of the municipality is to develop a new travel centre/meeting place with a lot more to offer than just travelling opportunities, taking advantage of the AVE's impacts and the location of the station.

Integrated ticketing, special and/or cross-border tickets have not been implemented to enhance long-/ short distance intermodality at the interchange.

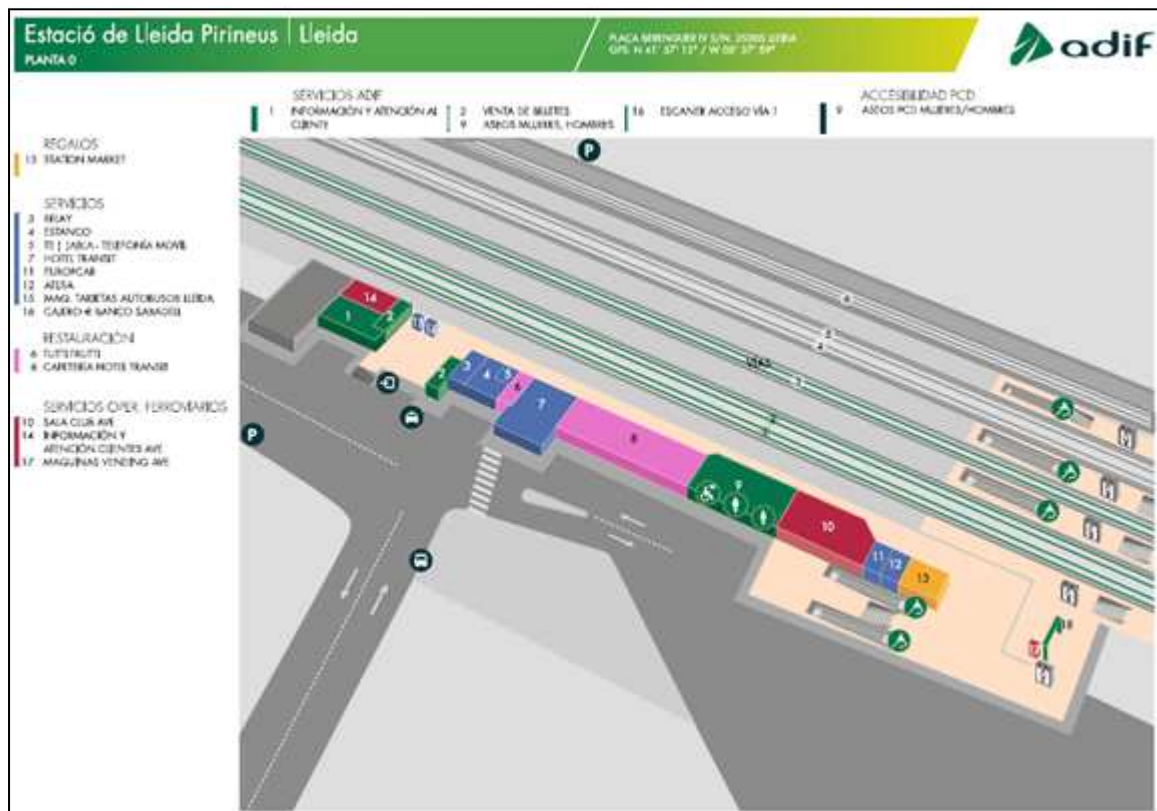


Figure 6.117 Services at Lleida Interchange.



Figure 6.118 Lleida Interchange: accessibility



Figure 6.119 Lleida Interchange: services



Figure 6.120 Lleida Interchange: waiting areas/spaces



Figure 6.121 Lleida Interchange: ticketing



Figure 6.122 Lleida Interchange: future construction near the interchange

6.3.1.3 Identification of the site

Transport modes	Rail	Bus	Air	Car	Ship and ferry
Geographical coverage	Rail services	Bus services	Air services	Car services	Ship and ferry services
a) Long distance services >100 km	1) International rail service	1) International bus service	1) International air service	1) Taxi 2) Mobility service for passengers with disabilities	1) International ship service (ocean liners) 2) International ferry service
b) Long distance air services >700 km	2) Interurban rail service	2) Interurban bus service	2) Interurban air service	3) Privat car 4) Rental car	3) Port-to-Port ferry service
a) Short distance services <100 km	1) Metro service 2) Tram service 3) Commuter train service	1) Interurban bus service 2) Urban bus service	1) International air service	1) Taxi 2) Mobility service for passengers with disabilities	1) Port-to Port ferry service 2) Pier-to-Port ferry service
b) Short distance air services <700 km	4) Interurban rail service	3) Shuttle service	2) Interurban air service	3) Privat car 4) Rental car	3) Pier-to-Pier ferry service

Figure 6.123 Long-distance services per mode and short-distance services per mode

6.3.1.4 Geographical coverage

6.3.1.4.1 Long distance

6.3.1.4.1.1 Zaragoza and Lleida Train Services

Renfe is the company that operates train services at Zaragoza and Lleida, trains travel to the following destinations:

- Andalucía (6 destinations to the provinces of Cádiz, Córdoba, Málaga and Sevilla)
- Aragón (3 destinations to the provinces of Huesca, Teruel and zaragoza)
- Asturias (2 destinations)
- Castilla la mancha (2 destinations to the provinces of Ciudad Real and Guadalajara)
- Castilla y León (8 destinations to the province of Burgos, León, Palencia, Salamanca and valladolid)
- Cataluña (6 destinations to the provinces of Barcelona, Girona, Lleida and Tarragona)
- Galicia (5 destinations to the provinces of La Coruña, Lugo, Orense and Vigo)
- Comunidad Valenciana (one destination)
- La Rioja (one destination)
- Madrid (2 destinations)
- Navarra (2 destinations)
- Basque Country (4 destinations)

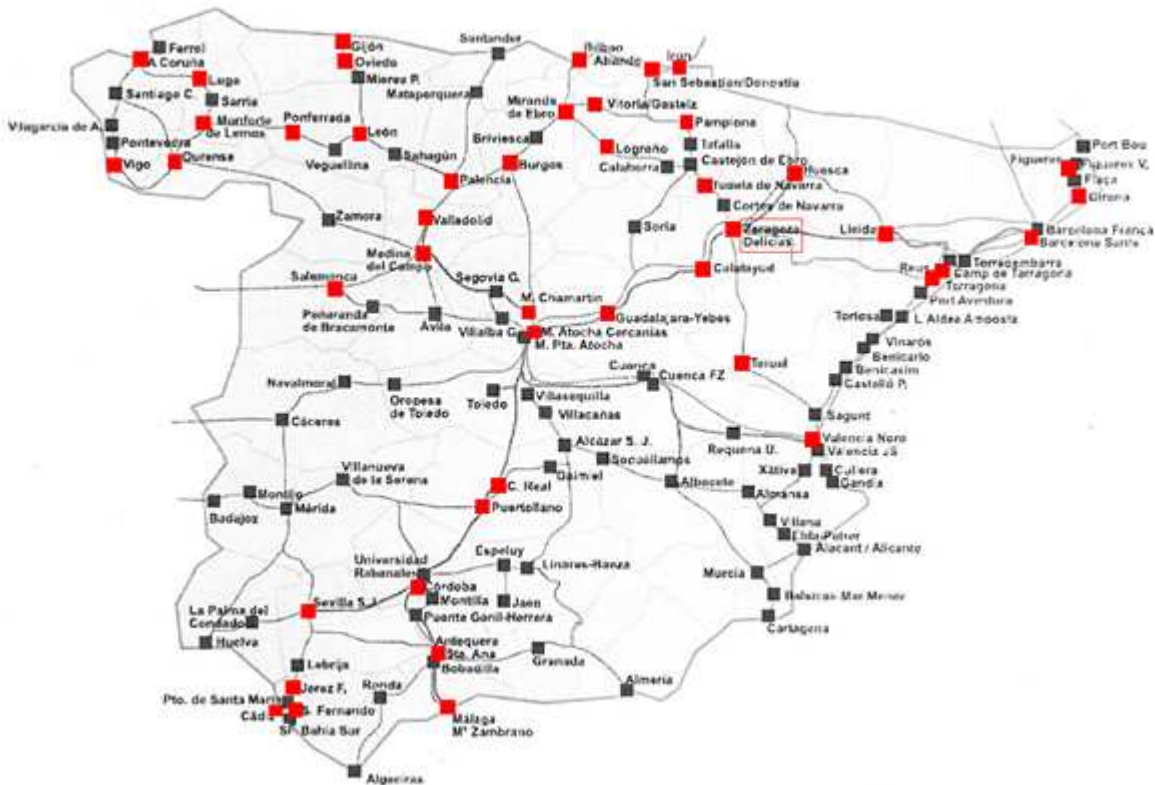


Figure 6.124 Geographical coverage. Long distance train services.

6.3.1.4.1.2 Zaragoza Bus services

6.3.1.4.1.3 International

ALSA, a long distance bus services operator at Zaragoza Interchange, is the company that offers bus services to international destinations, these buses travel from Zaragoza to the following destinations:

- Belgium (5 destinations)
- Czech Republic (2 destinations)
- France (52 destinations)
- Holland (6 destinations)
- Germany (27 destinations)
- Great Britain (one destination)
- Ital (15 destinations)
- Luxembourg (6 destinations)
- Marocco (16 destinations)
- Poland (25 destinations)
- Portugal (14 destinations)
- Romania (61 destinations)
- Switzerland (7 dewstinations)
- Ukraine (4 destinations)

Lines departing from Zaragoza Interchange cover almost 80 percent of the European destinations offered by the company.

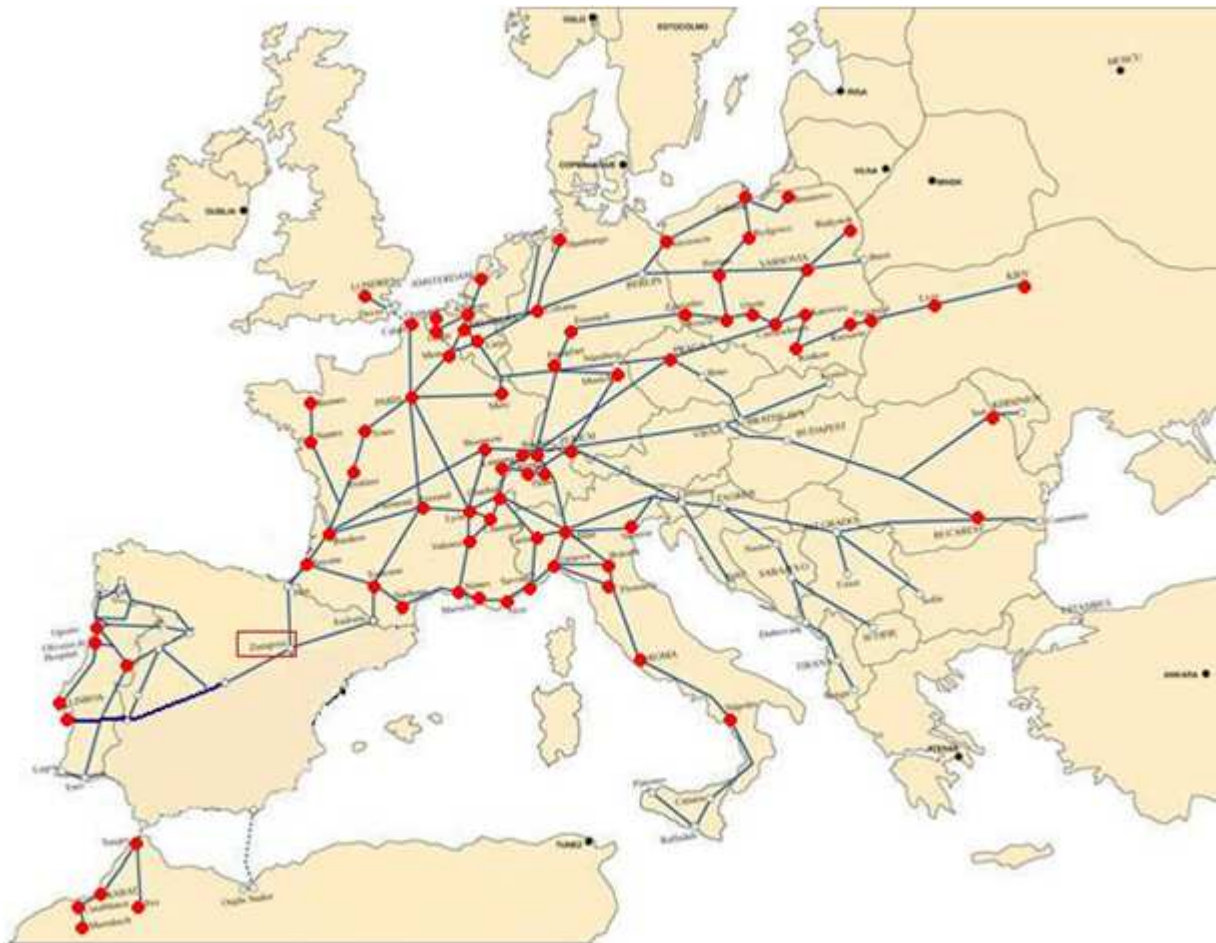


Figure 6.125 Zaragoza Interchange. Geographical coverage. International bus services.

6.3.1.4.1.4 National

ALSA, and other bus operators at the interchange offer service from Zaragoza Interchange to eleven Regions: Andalucía, Aragón, Asturias, Cantábria, Castilla la Mancha, Castilla y León, Cataluña, Galicia, Madrid, Navarra, País Vasco.

Andalucía (3 destinations in province of Granada)

Aragón (1 destination in Zaragoza)

Asturias (5 destinations)

Cantábria (4 destinations)

Castilla la Mancha (2 destinations to the provinces of Albacete and Guadalajara)

Castilla y León (11 destinations to the provinces of León, Palencia, Soria, Zamora)

Cataluña (3 destinations to the provinces of León, Palencia, Soria and Zamora)

Galicia (6 destinations to the provinces of La Coruña and Lugo)

Madrid (1 destination)

Navarra (12 destinations)

País Vasco (5 destinations to the provinces of Álava, Guipúzcoa and Vizcaia)

Lines departing from Zaragoza Interchange cover almost a 30 percent of the destinations offered by ALSA (which is the principal operator of the interchange), mainly the North destinations.



Figure 6.126 Geographical coverage. National bus services.

6.3.1.4.2 Short distance

6.3.1.4.2.1 Zaragoza Regional buses

CTAZ (Consortio de Transportes del área de Zaragoza), the Zaragoza Transport Authority, operates regional bus services in the area of Zaragoza, there are 18 regional lines, 2 of them stop at Zaragoza Interchange.

Line connecting the airport (Zaragoza- Plaza- Aeropuerto)

Line J (Zaragoza- Botorrita- Jaulín)



Figure 6.127 Zaragoza Interchange. Geographical coverage. Regional bus services.

6.3.1.4.2.2 Zaragoza Regional Rail Services

Renfe, the railway services operator offers one line at Zaragoza Interchange: C-1 Casetas Miraflores.



Figure 6.128 Zaragoza Interchange. Geographical coverage. Regional railway services.

6.3.1.4.2.3 Lleida Regional Rail Services

Renfe does also operate the only regional railway line at Lleida Interchange, the line FGC (Lleida-La Pobra de Segur).



Figure 6.129 Lleida Interchange. Geographical coverage. Regional railway services.

6.3.1.4.2.4 Zaragoza Urban buses

Tuzsa (Transportes Urbanos en Zaragoza) is the municipal company operating urban bus services in Zaragoza (Lleida interchange has no urban bus service).

This company offers 34 regular lines of urban buses, 7 night bus services and a tourist bus service. Four regular lines and the tourist line stop at Zaragoza Interchange.

Therefore travellers can not travel to the station after 1 a.m (there is no night service), and only a 11 % of the regular lines stop at the Interchange, which is not too much to be a point of intermodality.

The bus lines that stop at Zaragoza Interchange are:

Line 34 (Estación Delicias- Cementerio)

Line 51 (Príncipe Felipe- Estación Delicias)

Circular Line (With stops at Estación Delicias, Valle de Broto and Camino de las Torres among other)

Tourist Line (With stops at Avenida de Cataluña, Paseo Echegaray y Caballero and Avenida de Cataluña)

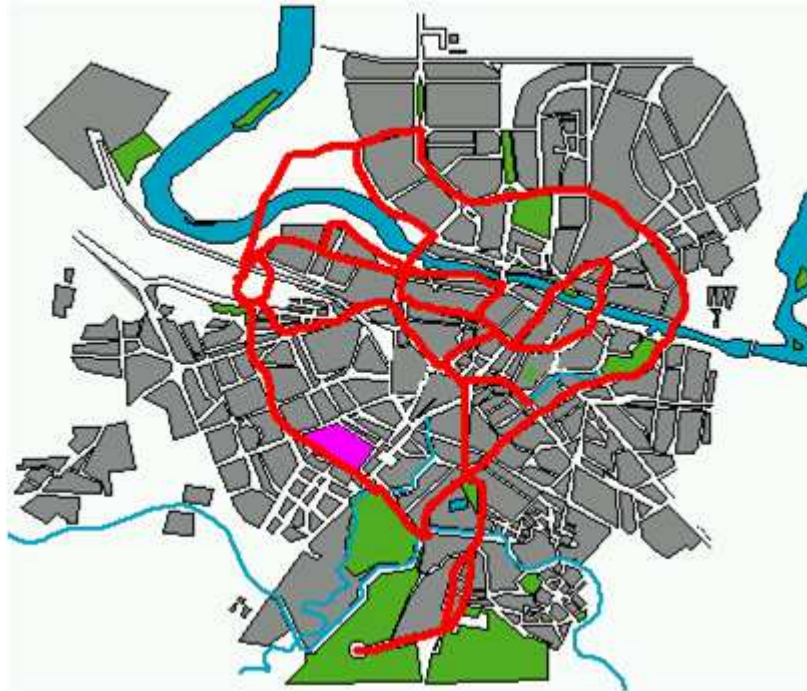


Figure 6.130 Zaragoza interchange. Geographical coverage. Urban bus services.

There are not urban bus stops at Lleida Interchange (there is not physical integration between modes).

6.3.1.5 Transport modes

Both intermodal stations operate railway lines and buses, as well as taxi service, covering all three levels of HERMES interconnectivity:

- Interfaces and interconnections between different modes;
- Interfaces and interconnections between different types of services of the same mode;
- Interfaces and interconnections between high capacity and low capacity mode.

In Zaragoza intermodal station the following transport services are provided:

6.3.1.5.1 Long distance services

High-speed Rail Service

- AVE Madrid – Barcelona, AVE Madrid-Huesca, AVE Málaga- Barcelona, AVE Barcelona-Sevilla

Long distance rail service (national)

- Alvia: Barcelona - Bilbao/Abando, Barcelona- Irún, Barcelona-Vigo
- Talgo: Zaragoza-Salamanca
- Trenhotel (night service): Barcelona- La Coruña San Cristobal, Barcelona- Vigo, Barcelona-Gijón, Portbou/ Cerbere- Madrid

- Lines: L-6 (Zaragoza - Teruel - Valencia Norte), R-4 (Zaragoza - Arcos de Jalón - Madrid), R-5 (Calatayud - Zaragoza), R-28 (Zaragoza - Tudela - Castejón - Logroño - Miranda de Ebro), R-32 (Zaragoza - Pamplona - Vitoria), R-41 (Zaragoza - Huesca - Canfranc), R-41 (Zaragoza - Huesca - Canfranc), R-42 (Zaragoza - Caspe - Barcelona), R-43 (Zaragoza - Lleida)
- Avant Calatayud- Zaragoza-Huesca

Long distance bus service (national)

- 11 lines to different destinations (Burgos, Salamanca, Soria, Madrid, Barcelona, Gijón, Murcia, Vigo, Santiago, etc)

Long distance bus service (international)

- Lines that links European cities (Portugal, Spain, France, Italy, Eastern countries).

6.3.1.5.2 Short distance/regional services

Regional rail service

- RENFE Cercanías Zaragoza (only one line: C1 Casetas-Miraflores)

Regional bus service

- Line connecting the airport (Zaragoza-Plaza- Aeropuerto)
- Line J (Zaragoza-Botorrita-Jaulín)

Urban bus service

- 3 regular lines: line 34, line 51 and circular line.
- Tourist line

Taxi service

In Lleida intermodal station the following transport services are provided:

6.3.1.5.3 Long distance services

High-speed Rail Service

- AVE Barcelona - Madrid
- AVE Barcelona - Sevilla
- AVE Barcelona - Málaga

6.3.1.5.4 Long distance rail service

- Alvia: Barcelona - Bilbao/Abando, Barcelona-Irún, Barcelona- Irún, Barcelona-Vigo
- Talgo: Barcelona-Bilbao/Abando, Barcelona-Hendaya, Barcelona- Salamanca

- Trenhotel (night service): Barcelona- La Coruña San Cristobal, Barcelona-Vigo
- Lines: Ca-4a (Lleida-Puigverd de Lleida-barcelona), Ca-4b (Cervera Hospitalet de Llobregat - Bell-lloc d'Urgell - Lleida), R-43 (Zaragoza - Lleida)
- Avant Lledida-Camp de Tarragona-Barcelona

6.3.1.5.5 Short distance/regional services

Regional rail service

- FGC: Lleida- La Pobla de Segur

Taxi service

6.3.1.6 *Services per transport mode*

6.3.1.6.1 Seats per mode

6.3.1.6.1.1 **High-speed Rail service**

The trains called AVE have a capacity of approximately 330 passengers per train.



Figure 6.131 Capacity of AVE trains.

6.3.1.6.1.2 **Long distance rail services**

Alvia trains have a capacity of 270- 340 seats and Talgo trains capacity goes from 170 to 360 seats (depending on the line and the passenger flow).



Figure 6.132 Capacity of Alvia trains.

6.3.1.6.1.3 **Long distance bus services**

ALSA long distance buses usually have 50 to 60 seats, although there are also buses from 40 to 50 seats.



Figure 6.133 Capacity of Long distance buses.

6.3.1.6.1.4 Short distance rail services

These kind of trains use to have a capacity of approximately 300 persons per train (80-150 seated)

6.3.1.6.2 Short distance buses

6.3.1.6.2.1 Regional buses

The average capacity for regional buses is from 60 to 70 seats per bus.

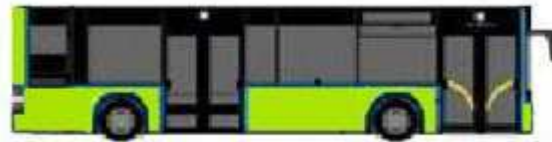


Figure 6.134 Capacity of regional buses.

6.3.1.6.2.2 Urban buses

The average capacity of urban buses is from 90 to 110 passengers per bus (18- 30 seated)

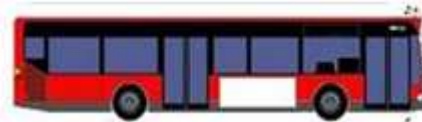


Figure 6.135 Capacity of Long distance buses.

6.3.1.7 Lines per mode and peak period

6.3.1.7.1 Short distance buses

In Zaragoza Interchange there are two regional bus lines, the one connecting the airport has a frequency of 30 minutes (from 6 to 24 hours), the line J offers two services per day, one in the

morning and the other one in the afternoon. There is also a regional railway line which frequency is 30 minutes (from 7 to 22 hours).

These means that with the capacity of the buses mentioned before, the line has a capacity of 130 passengers per hour, and 780 passengers per day.

The line J can be used by 120 passengers per day in each way.

The regional railway line can transport 600 passengers per hour, and 6000 per day.

Three regular lines of urban buses stop at Zaragoza Interchange, the frequencies of are 8-10 minutes (from 7:30 to 22 hours), the capacity of this lines is 650 passengers per hour, and 9100 per day.

6.3.1.8 Parking places

In Zaragoza Interchange there are two car parks, one in the northern part (with 1449 spaces) and the other one in the southern part (with 351 spaces). This means a really high capacity, bearing in mind that approximately 20 percent of the passengers arrive to the station by car.

In Lleida Station there is no parking integrated at the station, this surprises because a 40 percent of the passengers arrive to the station by car (maybe due to the bad connection with buses, among other things).

However it is foreseen to construct a new bus station next to the railway station, together with 600 parking lots, that will probably be successful because most passengers' choice is influenced for comfort and time trip rather than for ticket price.

6.3.1.9 Places reserved for disabled passengers

6.3.1.9.1 Train services

Renfe is the railway services operator (long distance as well as short distance).

This company offers special places reserved for disabled in a 75 % of the trains, those that have not got special places reserved offer other advantages (like services to help disabled to access to the trains or business tickets for the price of a tourist class ticket).

In addition, in case disability is the same or more than 60 %, there are discounts in some services (for example 25-40 % of discount in AVE tickets).

6.3.1.9.2 Long distance buses

ALSA buses don't have special places reserved for disabled, but they have facilities like ramps so disabled people can travel. Anyway the company should be warned before.

6.3.1.9.3 Short distance buses

Every bus has at least one place reserved for disabled, with the necessary safety devices.

6.3.2 Method for data collection

The planning and overall organisation tasks for case study n. 4 fall on all TRANSyT-UPM members, who will work and cooperate in WP5 activities, as concern the data collection, surveys' conduction and results' analisys.

6.3.2.1 *Observations and collected material*

6.3.2.1.1 Transport demand/Passenger flow

Data gathered from both customers' and stakeholders' survey

6.3.2.1.2 Time data

Data gathered from the customers' survey, questionnaires were distributed on Wednesday 11, Thursday 12 and Friday 13 of May, 2011; from 7.00 to 21.00 hours.

6.3.2.1.3 Space data

Data gathered from the customers' survey, questioners were distributed at the long distance quays and waiting areas, at Zaragoza and Lleida stations.

6.3.2.1.4 Information, Ticketing and Check-in Services data

Data gathered from both customers' and stakeholders' survey

6.3.2.2 *Customer survey*

6.3.2.2.1 Sample size

Questionnaires were made to 352 passengers.

6.3.2.3 *Distribution of the questionnaires*

Questionnaires were made to 230 passengers in Zaragoza Interchange (92 at Zaragoza-Rail Station and 138 at Zaragoza-Bus station), and to 122 in Lleida Interchange.

6.3.2.4 *Stakeholder interviews*

Interviews have took place in Stakeholders offices, and have lasted from one to two hours.

6.3.3 Stakeholders at the site

Following the Agent Based Modelling (ABM) suggested by WP2, the agents present at the WP3 case study Zaragoza-Lleida station interchange as surveys and personal interviews have evidenced, are as follows:

- Decision Maker (ADIF)
- Terminal Manager (ADIF)
- Train operators
- Long distance bus operators

Note that in this case Decision Maker and Terminal Manager are the same institution: the Railway Infrastructure Administrator (ADIF)

In the following sections we deal with this concept (agents) regarding several aspects needed for the validation of our prototype of business model.

6.3.3.1 Description of Stakeholders

The main stakeholders for case study 4 are the following ones:

ADIF – Administrador de Infraestructuras Ferroviarias

It is the Spanish state-owned company under the responsibility of the Ministry of Public Works and Transport, charged with the management of most of Spain's railway infrastructure (track, signalling and stations). It is the infrastructure administrator and the owner of the railway station of Zaragoza.

CTAZ – Consorcio de Transportes del Área de Zaragoza / ATM - Autoritat Territorial de la Mobilitat del Area de Lleida

The Transport Authorities of Zaragoza and Lleida are made up of several municipalities of the areas of Zaragoza and Lleida region, respectively. The objective of these *consortium* is the technical, institutional and economic integration among all associated entities, as well as with the central government, as concerns planning and management of transport services and infrastructures.

Ayuntamiento de Zaragoza / Ayuntamiento de Lleida

The municipalities of Zaragoza and Lleida are the institutions that administer the cities of Zaragoza and Lleida, respectively. They are the owner of the land and the car-parking lots surrounding the interchanges.

Terminal managers of the interchanges

They are responsible for the interchange's managements, that means operational issues, maintenance and monitoring issues, coordination among transport services, emergency situations, etc. In Zaragoza there are two managers: gerente de la estación de trenes (Mr Ricardo Miranda - ADIF) + gerente de la estación de autobuses (Mr Iñigo Laín - private company). In Lleida there is just one terminal manager: gerente de la estación de trenes (Mrs Montserrat Sáez - ADIF).

Transport operators: public and private companies

As regards railway services, the public company Renfe Operadora operates rail passenger services (long-distance, intercity, regional) and competes with public/private transport operators (an example: Ferrocarriles de la Generalidad de Cataluña at Lleida interchange). As regards bus services, urban services are provided by municipal companies: Tuzsa (Zaragoza) and Autobuses de Lleida S.A. (Lleida). Transport operators that provide regular bus services are: ALSA, Autocares Samar, Renfe-Iñigo S.A., Autobuses Jiménez, etc. Different taxi private operators are also operating at both stations, e.g. Radio Taxi Zaragoza and Autotaxi Teleradio Lleida.

Other services: private companies

Several private companies dealing with transport services and other issues: rental car companies (Avis, Europcar, Atesa), commercial and retail activities (Imaginarium), restaurants/café (Café&Té), travel agency (Corte Inglés), hotels (Hotel Husa Puerta de Zaragoza), companies dealing with information system control and

6.3.3.2 Interaction between Stakeholders

		 	 	Terminal managers	Transport operators 	Other companies
	ADIF is responsible for the following issues at interchanges: accessibility, information, safety/security, customer services, etc.			ADIF is responsible for the appointment of the terminal managers.	ADIF defines, quality standards in contracts, access conditions, capacity allocation for rail companies.	ADIF outlines rules, procedures, standards for retailers and the provision of additional service within the interchange.
 		Transport Authorities combine the efforts of public and private institutions related to Public Transport for the purpose of coordinating services, networks and fares.			Transport Authorities coordinate public and private operators.	
 			Municipal governments are responsible for planning and regulating urban public transport (Department of transportation / mobility).		Municipal governments contract out the provision of passenger services by the private sector.	They collaborate with ADIF to set the level of retailer rents
Terminal managers	Terminal managers are from ADIF: they inform ADIF about services operations, incidents, alterations, etc.			They manage the interchange and define the agents to contract.		They control that companies operating at interchanges respect the regulatory framework.
Transport operators 	Rail companies pay operating fees for use of rail infrastructures.			Transport operators provide transport modes through agreements with the infrastructure manager.	Rail/bus companies are responsible for transport operations, vehicle maintenance, etc.	
Other companies	Retailers and other shopkeepers pay a fee to provide their service at interchanges.					Retailers and other companies provide additional service at interchanges

Figure 6.136 Interaction between stakeholders

6.3.3.3 Graphical representation



Figure 6.137 Graphical representation

Terminal Manager and **Decision Makers** work for the same company, ADIF (owner of the railway infrastructure in Spain, and responsible of its maintenance)

Terminal Manager manages the interchange, defines contract agreements and controls that **Transport Operators** respect regulations

Transport Operators (public and private) pay operating fees to **Terminal Managers** for using the infrastructures

Transport Operators provide service to **Users**

6.3.4 Current short-long interconnectivity problems/opportunities

6.3.4.1 Zaragoza

Problems and opportunities at Zaragoza interchange can be summarised in the following key-issues:

1. The station itself is on the edge of the city centre: potential demand is maybe missing, especially during the night.
2. The building is spacious and walking distances among transport modes and/or services are quite long. Consequently access/egress and transfer times are high.
3. The building is roomy: ventilation, heating and air-conditioning are serious problems the interchange's management. Waiting areas have been constructed as closed spaces to avoid this problem (but passengers waiting at platforms).

4. There is no integrated information between bus and rail modes, except to indicate access to the bus station from the railway station. There is also a lack of tariff integration.
5. Bus and rail transport services do not match from.
6. There is lack of shops and retail activities for such a big space: marketing opportunities have maybe been missed.
7. There is no real physical interconnectivity between both railway and bus stations.

6.3.4.2 *Lleida*

Problems and opportunities at Lleida interchange can be summarised in the following key-issues:

1. Intermodality between rail and bus services has not to be enhanced yet, since the actual bus central station is far from the railway station Lleida. Actually, rail-bus services intermodality can only be provided by urban bus services.
2. There is no integrated passengers information in the interchange: only information on rail services is provided.
3. Additional services for passengers should be provided (see the new shopping centre that will be constructed in the upcoming years).
4. Market expansion strategies should be explored and analysed, such as a better interconnection between the city and ski resorts, as well between the city and foreign destinations (cross-border agreements).
5. Connection with surrounding areas should be analysed to improve the role of the interchange in the city (the short/regional services Rodalies Lleida, Cercanías Lleida will be implemented with this purpose).
6. There is a lack of coordination among operators, regarding timetables (bus+rail services) and tariffs.

6.3.5 Current value proposition

6.3.5.1.1 Zaragoza










<p>Key Partners </p> <ul style="list-style-type: none"> •Railway infr administrator (ADIF) •Railway operator (RENFE) •Long distance bus operators •Local Transport Authorities 	<p>Key Activities </p> <ul style="list-style-type: none"> •Connecting land transport modes <hr/> <p>Key Resources </p> <ul style="list-style-type: none"> •High Speed Railway Services 	<p>Value Proposition </p> <ul style="list-style-type: none"> •Integrated information systems about all modes •Elimination of physical barriers between train and bus •Improvement of traffic management •Local transport Authorities more involved in station management •Collaboration between Terminal Manager and Operators 	<p>Customer Relationships </p> <ul style="list-style-type: none"> • Info-desk • Real-time info display <hr/> <p>Channels </p> <ul style="list-style-type: none"> • Web site • info desk 	<p>Customer Segments </p> <ul style="list-style-type: none"> •Bus services: <ul style="list-style-type: none"> • Low income • Youngers •High speed Railway services <ul style="list-style-type: none"> • High income • Business
<p>Cost Structure </p> <ul style="list-style-type: none"> •Bus Operators are focused on minimizing cost (their customers demand it) •Renfe (railway operator) is focused on maximising revenue 		<p>Revenue Streams </p> <ul style="list-style-type: none"> •Fees for use railway infrastructure •Fees for long distance and regional bus services •Renting space for retail activities 		

Figure 6.138 Current value proposition Zaragoza

6.3.5.1.2










<p>Key Partners </p> <ul style="list-style-type: none"> •Railway infr administrator (ADIF) •Railway operator (RENFE) •Local Transport Authorities 	<p>Key Activities </p> <ul style="list-style-type: none"> •Connecting land transport modes <hr/> <p>Key Resources </p> <ul style="list-style-type: none"> •High Speed Railway Services 	<p>Value Proposition </p> <ul style="list-style-type: none"> •Integrated information systems about all modes •Parking lots •Improvement of frequencies of bus lines (between bus and train station) •Local transport Authorities more involved in station management •Collaboration between Terminal Manager and Operators 	<p>Customer Relationships </p> <ul style="list-style-type: none"> • Info-desk • Real-time info display <hr/> <p>Channels </p> <ul style="list-style-type: none"> • Web site • info desk 	<p>Customer Segments </p> <ul style="list-style-type: none"> •High speed Railway services <ul style="list-style-type: none"> • High income • Business
<p>Cost Structure </p> <ul style="list-style-type: none"> •Renfe (railway operator) is focused on maximising revenue 		<p>Revenue Streams </p> <ul style="list-style-type: none"> •Fees for use railway infrastructure •Renting space for retail activities 		

Figure 6.139 Current value proposition Lleida

The new value proposition is based on the need to improve **integration between the long and the short distance services**, mainly based on the integration of Unimodal Transport Service Legs, as proposed in WP2. Following chapters will develop this issue in depth.

6.3.6 Description of current business model

The current Business Model at Zaragoza and Lleida intermodal stations is described following the 9 building blocks of Osterwalder approach (WP2). Many of the questions will be answered in the interviews/customer survey.

6.3.6.1 Customer Segments (CS)

- How many passengers per day? And per year?

There is no specific data about this number, but as an example, according to the Terminal Manager; the long distance railway lines between Madrid-Barcelona (which has stops at Lleida and Zaragoza) has 3.300.000 passengers per year (most of them High Speed Railway services), and more or less 2.295.000 passengers per year pass through the bus Station at Zaragoza.

- What is the genders' percentage?

According to the surveys male's percentage is 41 % and female's is 59 % at Zaragoza and 42 % male, 58 % female at Lleida.

(Note that % are based on the surveys carried out, i.e., the interviewer maybe has found easier to interview women than men, or women could have been more easily addressed)

- What is the passengers' percentage between 0-25, 26-40, 41-60, more than 61 years?

According to the surveys:

Between 0-25 years: 16 % (Zaragoza), 11 % (Lleida)

Between 26-40 years 44 % (Zaragoza), 38 % (Lleida)

Between 41-60 years 31 % (Zaragoza), 45 % (Lleida)

More than 60 years 9 % (Zaragoza), 7 % (Lleida)

(Please, see the note above regarding gender)

- What is the passengers' percentage with reduced mobility?

3 % according to the Terminal Manager.

- What are the passengers' most common destinations?

According to the Terminal manager, all destinations with high speed railway services (especially Madrid, Sevilla and Valencia), and destinations in the North of Spain, offered by bus companies.

- What is the passenger's travel purpose?

According to Transport Operators business for high speed railway passengers; and private trip for bus travellers (surveys corroborate it)

- What class do passengers chose to travel?

According to all stakeholders passengers usually prefer tourist class (specially bus passengers).

6.3.6.2 Value Proposition (VP)

- What kind of transport services does the company offers (e.g. short/long distance, types of transport, etc)?

Zaragoza: high speed railway services (AVE), long distance railway services, regional railway services, long distance buses, regional buses (two lines), urban bus services (four lines) and taxi services.

Lleida: speed railway services (AVE), long distance railway services, regional railway services, urban bus services (four lines) and taxi services.

- What are the different services provided by the company (e.g. combination with other transport modes, ticket for O/D or ticket for service, etc)?

Long distance buses and long distance trains: the ticket is purchased from a source to a certain destination, and also for a certain day, and time of departure and it is not valid for other destinations or timetables.

Regional buses: one ticket can be used for one line and one trip, the price varies depending on the line and destination.

A ticket for short distance can be used at any time. (It is not for a specific date)

- Does transport services presents different travel classes?

Yes, but only long distance buses and trains they offer business and tourist class.

- Does the provided service allows utilization by people with reduced mobility?

Yes, transport operators provide low-floor vehicle technology and both interchanges have lifts, escalators, wheelchair ramps that allow accessibility for mobility impaired passengers.

- What are the main reasons for passengers chose this company over another?

The main reason for passengers of long distance buses is the price of the tickets, and passengers of long distance trains are comfort and travel time.

- What are the company's service levels (e.g. reliability, punctuality, etc)?

Punctuality, specially for high speed railway services (they refund the price of the ticket if it is late)

6.3.6.3 Channels (CH)

- What are the channels that the company uses to spread information (e.g. website, displays on platforms, etc)?

Information is provided in website and inside both of the interchanges, by monitors on platforms.

There are information desks available for questions.

- How does the company raise awareness (e.g.: advertisement, etc) about its services?

Through visual information at interchanges, as well as its webpage. Audio advertisements are avoided at interchanges not to bother passengers.

- How does the company sells tickets?

Rail services: self check-in ticket machines, personnel at ticket offices, personnel on-board, on-line. Bus services: tobacconist, on-board (bus driver). Taxi: on-board.

Does the company provides any after-sales customer support?

Yes, ticket changes and refunds but only for long distance buses and trains (high speed trains refund the price of the ticket if it gets late.

6.3.6.4 Customer Relationships (CR)

- How does the customer interact with the company?

Customers can use the web site, the telephone or box office.

- Fidelity programs (e.g. frequent flyer, etc)?

Yes, Alsa and Renfe offer a target; customers have discounts in tickets and other advantages for using it.

- Does the company have information desks?

Yes there are information desks at both interchanges.

- Ticket sells is based on machines or employees?

Both systems are available for rail and bus services at Zaragoza. In Lleida machines and ticket office are available for rail services.

6.3.6.5 Revenue Streams (R\$)

- What are the revenue sources (e.g.: tickets, advertisement, retail)?

Fees paid by Transport operators for using the infrastructure; and fees paid by retailers and other shopkeepers to provide their service at the interchanges.

- If there are other revenue sources, how much they represent?

There is a hotel in each Interchange paying for using the space.

- What is the ticketing scheme?

Rail and bus services pay a fee for using the platforms and the station services. It is calculated based on a formula dependent of the number of travellers and the number of services (buses and trains)

- Does the company have revenue management system?

Not a specific system, they try to improve revenues but the public body ADIF is managing the whole stations system and have no specific accountancy for each station.

6.3.6.6 *Key Resources (KR)*

- What are the company's financial resources?

ADIF is a public company and it is managed within the so called group of Transport Ministry Companies. These some common strategies and cross-subsides among them.

- What kind of human resources does the company has?

The ones you can find in any company (administrative, management staff...), and a high number of technical personnel.

- What is the company's physical resources

Adif has offices and all the necessary physical resources for its business through all the country.

- What is the company's R&D activities (e.g. patents, databases, etc)?

The company focus the attention on construction and maintenance of the railway infrastructure network. Therefore keeps the information and develops the corresponding R+D actions.

6.3.6.7 *Key Activities (KA)*

- What are the main activities in the platform/network sector?

The main activities are construction and maintenance of the railway infrastructure, and defining quality standards in contracts, access conditions and capacity allocation for railway operators.

- Is the company involved in other activities besides transport?

All the activities of Adif are related to transport

6.3.6.8 *Key Partnerships (KP)*

- Does the company has partners? What sort of partners?

ADIF –terminal manager- is a public body, and has no proper partners.

- What kind of agreements does the company have with its partners (e.g. advertising, revenue share, etc)?

Information will be provided by all stakeholders of the interchanges.

6.3.6.9 *Cost Structure (C\$)*

- Does the company's cost structure is based on minimizing cost for the passengers or focus on value creation (maximising revenue)?

Bus operators are focused on minimizing costs (their customers demand it), and Renfe (railway operator) is focused on maximising revenue.

- What kind of economies does the company have (e.g.: scale, density and scope)?

Rail companies have clear economies of scale because they manage the vast majority of the rail network in Spain (Adif) and rail services (Renfe). On the contrary the bus systems is quite atomized with many operators mainly at regional and local level.

6.3.7 Current level of quality of services and customer satisfaction

6.3.7.1 Description general information about the passenger

The journey has been divided into two stages the first one from the passenger origin to the interchange and the second one from the interchange to the destiny:

6.3.7.1.1 Transfer of modes

The surveys were made at the quays of long distance buses, and waiting areas for train passengers; and were answered mainly by passengers who were waiting to take a long distance mode (maybe because for them it did not suppose a loss of time to answer to the questions).

- Zaragoza

In Zaragoza Interchange, a 37% of the respondents had gone to the interchange to get a long distance train, and a 58 % to get a long distance bus.

The surveys showed two kinds of passengers with different behaviours: long distance bus users, who were young and with lower income; and long distance train users who were middle age and with higher income. This affects the short distance mode they choose to get to the Interchange; most long distance bus travellers arrived by short distance bus, while long distance train travellers arrived mostly by private modes (taxi or car).

		Zaragoza Interchange. Transfer (%)							
		Departs							
		Long distance train	Short distance train	Long distance bus	Short distance bus	Airport bus	Taxi	Car	
Arrivals	Long distance train			1,3				1,8	3,1
	Short distance train	0,4		0,4					0,9
	Long distance bus	0,4		10,7	0,9			1,8	13,8
	Short distance bus	12,0		35,1					47,1
	Airport bus			0,4					0,4
	Taxi	12,4		4,0					16,4
	Car	12,0		6,2					18,2
		37,3		58,2	0,9			3,6	

Figure 6.140 Departures and arrivals Zaragoza

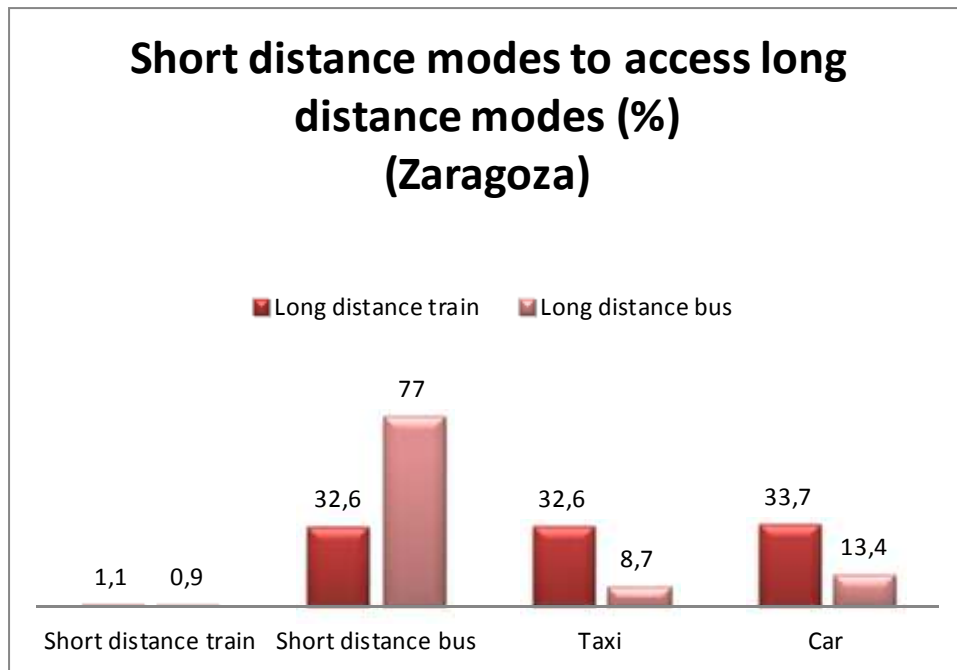


Figure 6.141 Zaragoza Interchange. Short distance modes

o Lleida

In Lleida Station, most respondents had gone to the Station to get a long distance train (86 %), and most of them had done a short distance trip to the station (except from a 4 %, who were going to take another long distance train).

Most passengers from LLeida arrived to the station by car.

		Lleida Station. Transfer (%)						
		Departs						
		Long distance train	Short distance train	Local Bus	Taxi	Car	Bicycle	
Arrivals	Long distance train	3,8						3,8
	Short distance train	6,7						6,7
	Local Bus	18,1	2,9					21,0
	Taxi	20,0	1,0					21,0
	Car	36,2	7,6	1,9				45,7
	Bicycle	1,0						1,0
		85,7	11,4	1,9				

Figure 6.142 Departures and arrivals Lleida

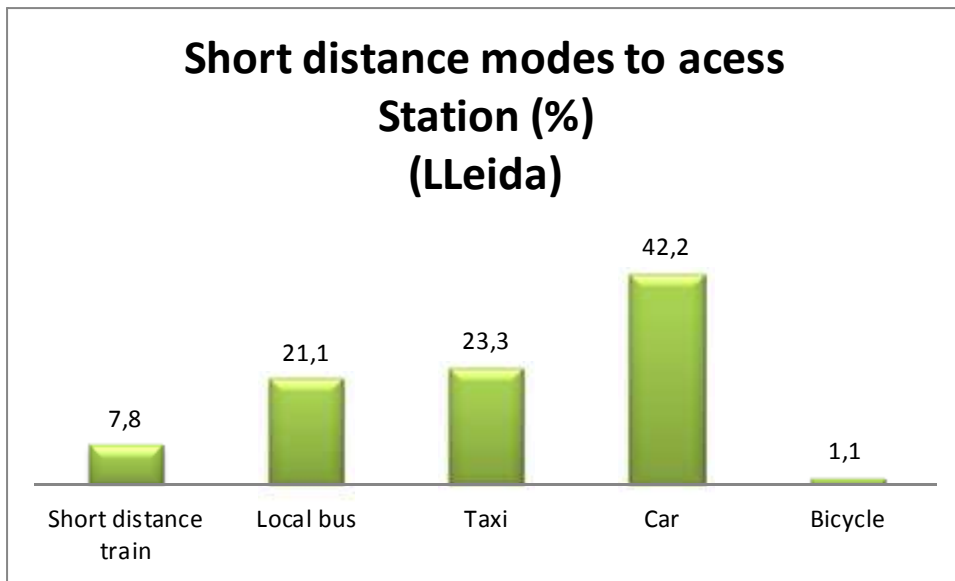


Figure 6.143 Lleida Interchange. Short distance modes

6.3.7.1.2 Main mode of transport

Regarding the main mode of transport in passengers' journey for a high number of them was the long distance train, especially at Lleida (82 %), while at Zaragoza 41 %), but at Zaragoza there were more passengers whose main mode of transport was the long distance bus (59 %).

	Main mode of transport (%)	
	Zaragoza	Lleida
Long distance train	41,3	81,8
Commuter train	0,0	10,7
Long distance bus	58,7	6,6
Airplane	0,0	0,8

Figure 6.144 Main mode of transport

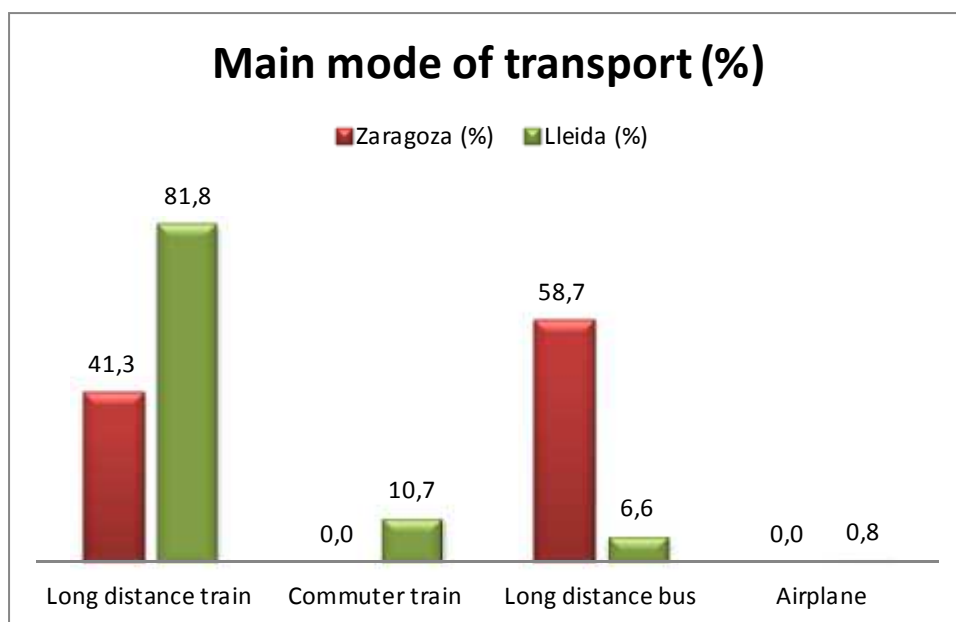


Figure 6.145 .Main mode of transport.

6.3.7.1.3 Distance and time

According to this distribution of modes, most passengers journey consisted on a short distance trips (from 5 to 10 km and from 10 to 30 minutes) to the interchange from 5 to 10 km and then a long distance trip from the interchange to their destiny (of about 700 km and from 1 to 4 hours).

	Distance of the trip (%)	
	To the interchange	From the interchange
< 1 km	4,6	0,3
5 km	45,9	2,9
10 km	19,9	2,3
100 km	14,8	9,5
700 km	13,7	79,5
> 700 km	1,1	5,5

Figure 6.146 Distance of the trip

	Time of the trip (%)	
	To the interchange	From the interchange
< 10 min	23,1	2,3
10 - 30 min	49,1	4,9
30 min - 1h	10,3	11,8
1h - 2h	9,1	35,6
2h - 4h	6,3	30,2
> 4 h	2,0	15,2

Figure 6.147 Time of the trip

6.3.7.1.4 Passengers' personal characteristics

For these personnel characteristics, passengers were asked for gender, age and purpose of travel.

Profiles are similar for train passengers at both stations and these different from bus passengers, so we have aggregated data for Zaragoza and Lleida train passengers.

Respondents were mostly female, but percentage of females out of bus travellers (63 %) was higher than the one out of train travellers (54%).

Train users were mostly middle age (40 % between 36-55 years) and were travelling for business reasons; while bus users were mostly young people (43 % between 21-35 years) and were travelling for private reasons.

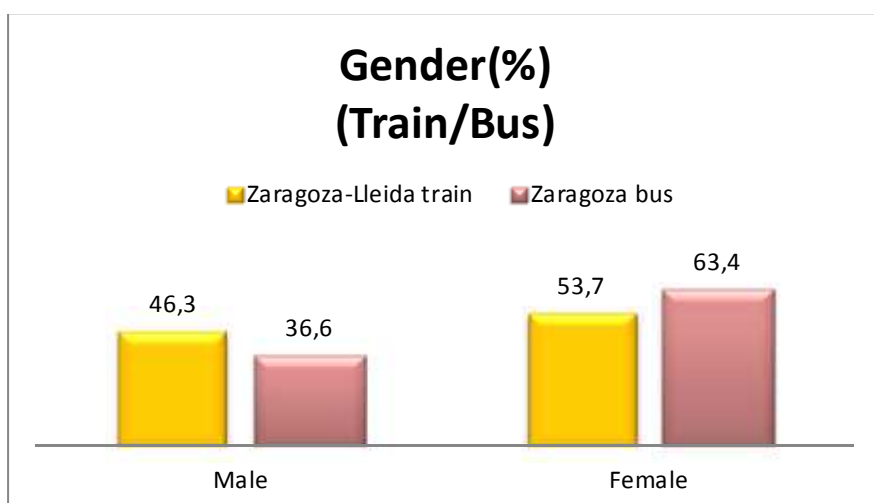


Figure 6.148 Gender

	Zaragoza-Lleida train	Zaragoza bus
15-20	6,3	25,2
21-35	39,5	42,7
36-55	40,5	16,8
56-64	6,3	5,3
>64	7,4	9,9

Figure 6.149 Age

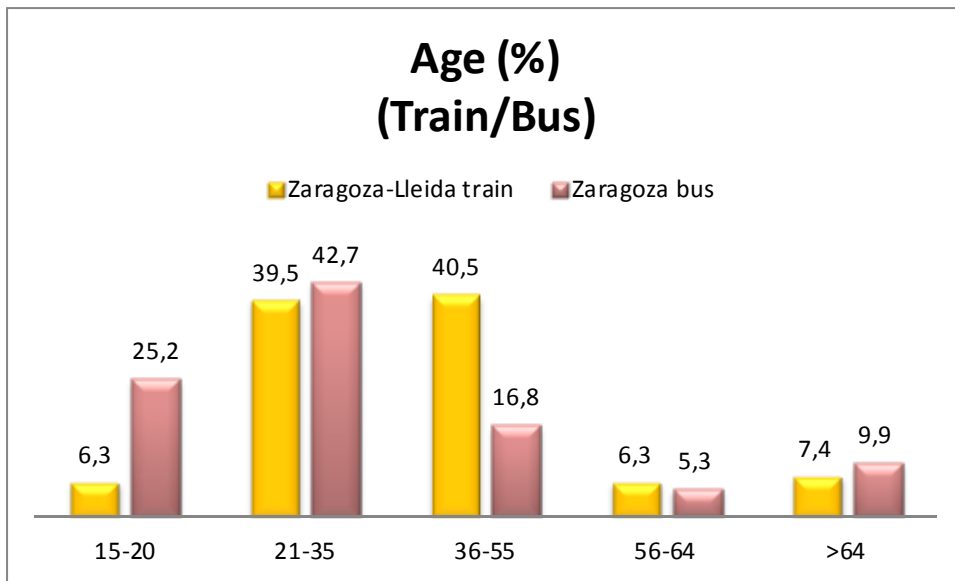


Figure 6.150 Age

	Zaragoza-Lleida train	Zaragoza bus
Business	39,7	15,9
Studies	7,9	13,8
Private	36,9	60,9
Other	15,4	9,4

Figure 6.151 Purpose of trip

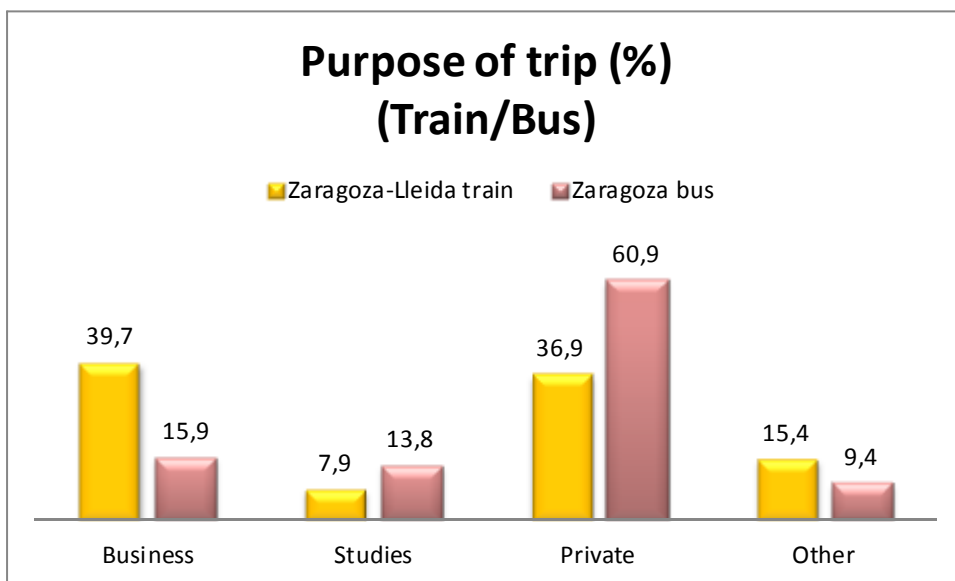


Figure 6.152 Purpose of trip

6.3.7.2 Travel demand/Passenger flow

In this section we try to evaluate if services provided are proportional to the passenger flow, analysing first general aspects as travel supply or main influencers on passengers' decisions, and then aspects related to time and space as quality of services' indicators.

6.3.7.2.1 Travel supply

- Zaragoza Interchange

Regarding opinion about travel supplies, most passengers seemed to be quite satisfied. Out of this, coordination timetables were the best valued, and use of waiting time the worst.

	Satisfaction of Travel supply				
	Very diss.	Quite diss.	No sat. or diss.	Quite sat.	Very sat.
Coordination Timetables	2,0	7,0	18,0	46,0	27,0
Travel Connections	5,0	12,0	18,0	37,0	29,0
Combine Modes	9,0	13,0	19,0	42,0	17,0
Use Waiting Time	10,0	24,0	27,0	30,0	8,0

Figure 6.153 Satisfaction with travel supply, Zaragoza

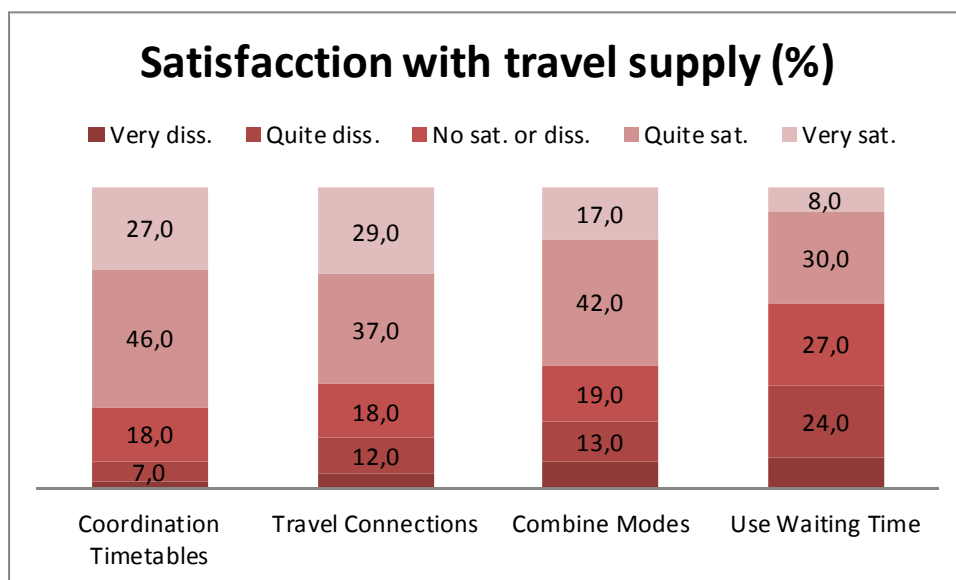


Figure 6.154 Zaragoza Interchange. Satisfaction with travel supply.

- Lleida interchange

Regarding opinion about travel supplies, most passengers seemed to be quite dissatisfied, especially with combine modes and travel connections, and except for coordination of timetables.

	Satisfacction with travel supply (%)				
	Very diss.	Quite diss.	No sat. or diss.	Quite sat.	Very sat.
Coordination Timetables	25,0	18,0	7,0	13,0	37,0
Travel Connections	34,0	26,0	14,0	12,0	15,0
Combine Modes	38,0	23,0	11,0	22,0	7,0
Use Waiting Time	32,0	33,0	18,0	15,0	1,0

Figure 6.155 Satisfaction with travel supply, Lleida

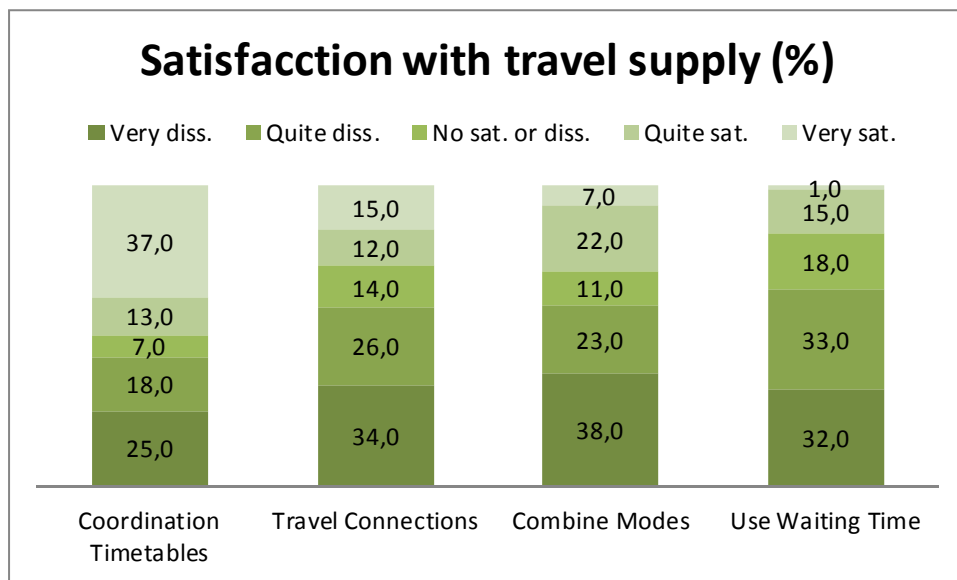


Figure 6.156 Lleida Interchange. Satisfaction with travel supply.

6.3.7.2.2 Main factors that influence the passengers choice

Main factors of influence for train passengers were firstly travel time (46 %) and secondly comfort (22 %), while main factor for bus users was ticket price (42 %).

Influencers	Zaragoza-Lleida train (%)	Zaragoza bus (%)
Price	5,0	41,6
Comfort	22,3	8,0
Punctuality	9,9	4,0
Travel time	45,5	8,8
Safety	1,0	1,6
Simplicity of transfer	2,0	5,6

Quality of service	1,5	2,4
Waiting time	0,5	2,4
Other	12,4	25,6

Figure 6.157 Main factors of influence

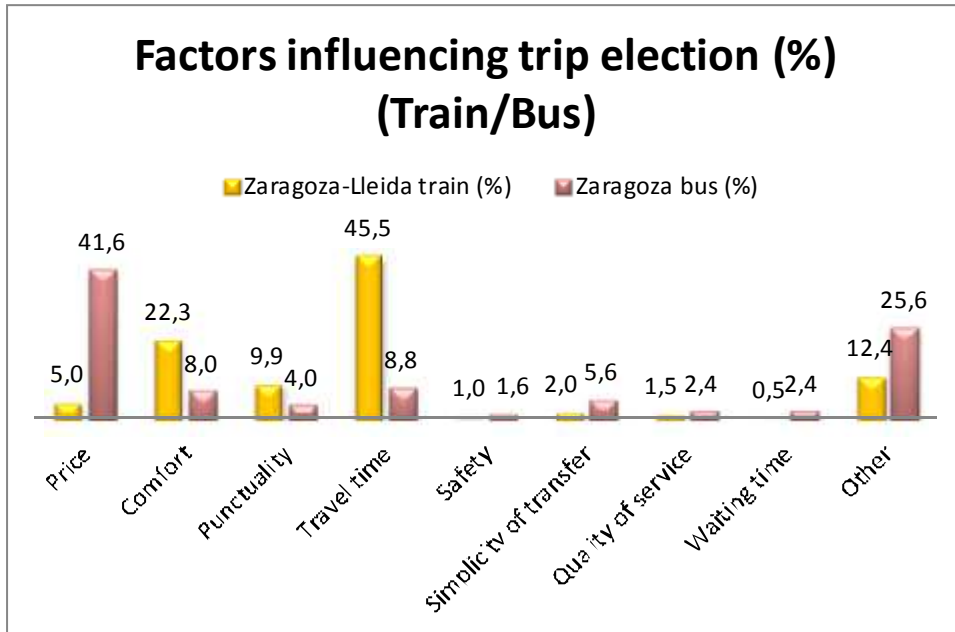


Figure 6.158 Influencers.

6.3.7.3 Time

In this section time has been considered as an indicator for the quality of the services; and trans-boarding time (total time that passengers are going to spent at the interchange) has been divided as follows:

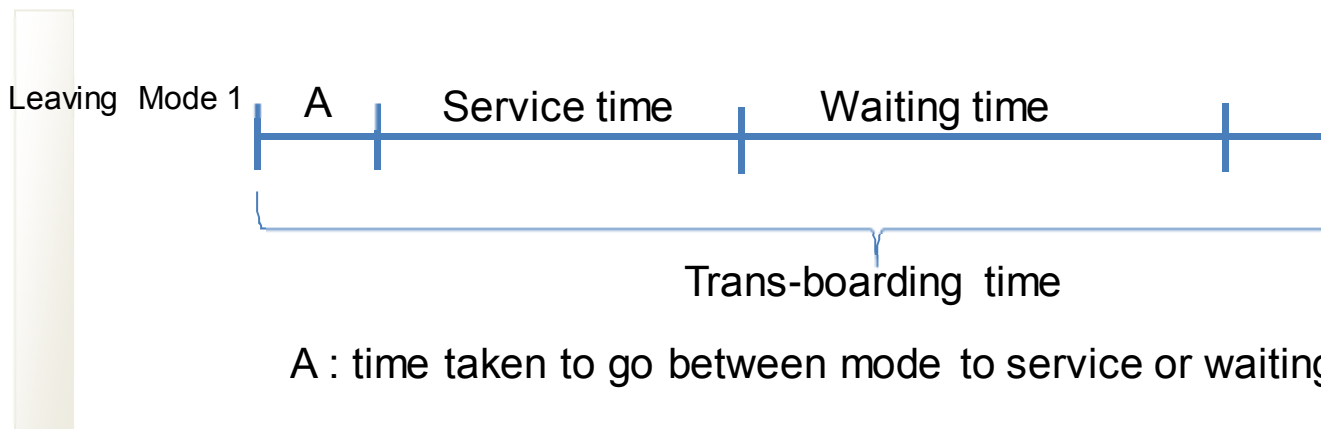


Figure 6.159 Time division.

6.3.7.3.1 Service time

Passengers were asked about two aspects of service time: time dedicated to baggage and time for disabled to reach different points at the interchange.

Most passengers were quite satisfied with both aspects specially with time baggage and specially passengers at Lleida.

		Service time (%)				
		Very diss.	Quite diss.	No sat. or diss.	Quite sat.	Very sat.
Zaragoza	Time baggage	1,0	4,0	13,0	40,0	41,0
	Time disabled	6,0	13,0	23,0	36,0	21,0
Lleida	Time baggage	0,0	0,0	14,0	30,0	55,0
	Time disabled	16,0	23,0	5,0	38,0	18,0

Figure 6.160 Service time

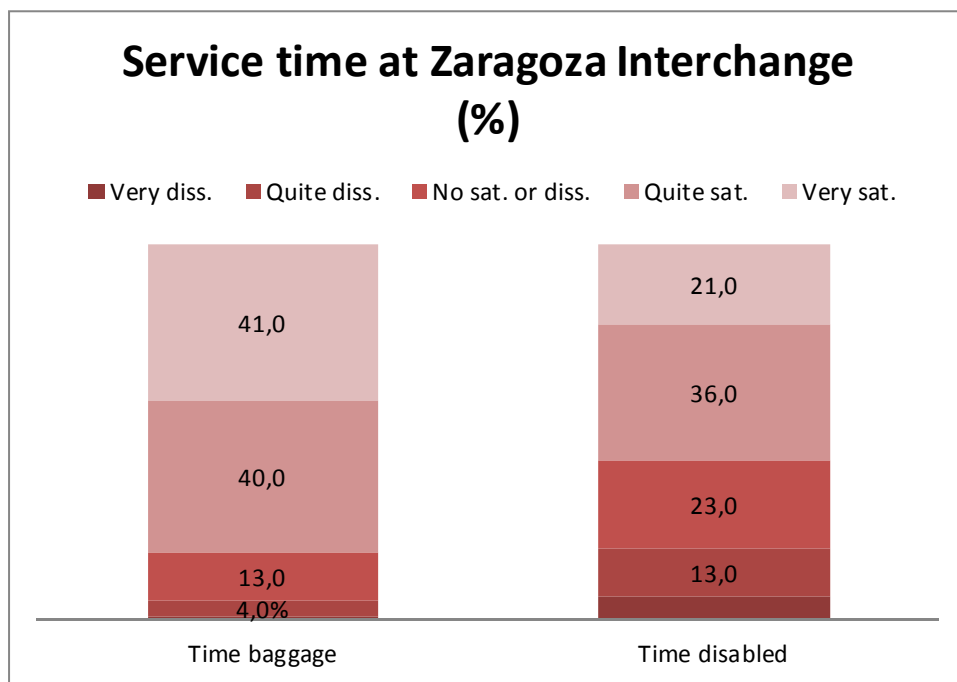


Figure 6.161 Zaragoza Interchange. Satisfaction with service time.

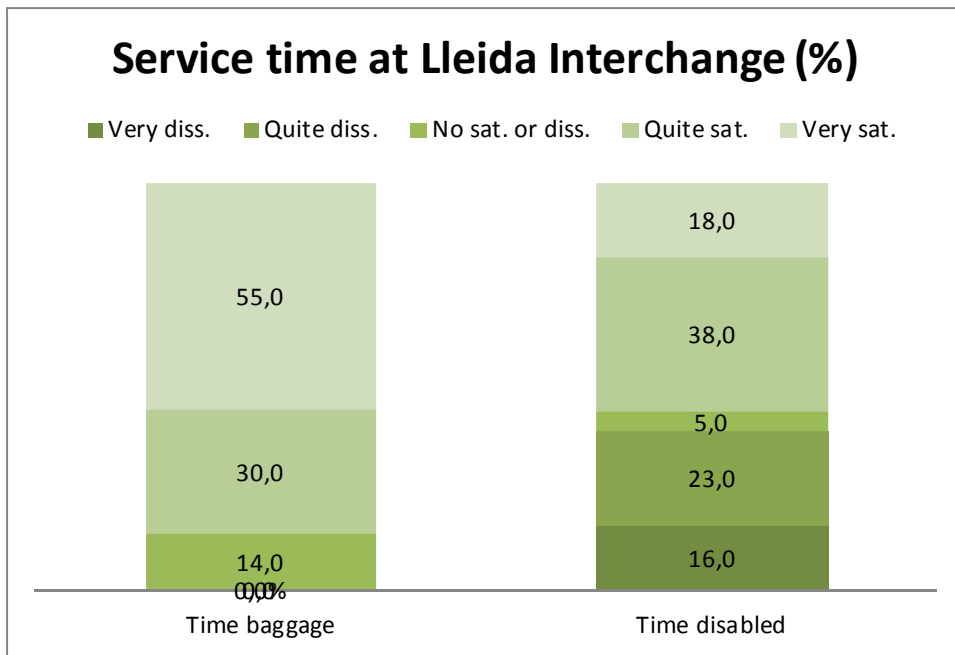


Figure 6.162 Lleida Interchange. Satisfaction with service time.

6.3.7.3.2 Waiting time

Passengers were asked about total waiting time and about punctuality.

Most passengers were very satisfied with these aspects especially with punctuality, and specially passengers at Lleida

		Waiting Time (%)				
		Very diss.	Quite diss.	No sat. or diss.	Quite sat.	Very sat.
Zaragoza	Punctuality	0,0	1,0	10,0	34,0	55,0
	Total waiting time	2,0	7,0	21,0	49,0	21,0
Lleida	Punctuality	0,0	2,0	1,0	44,0	54,0
	Total waiting time	6,0	11,0	19,0	21,0	42,0

Figure 6.163 Waiting time

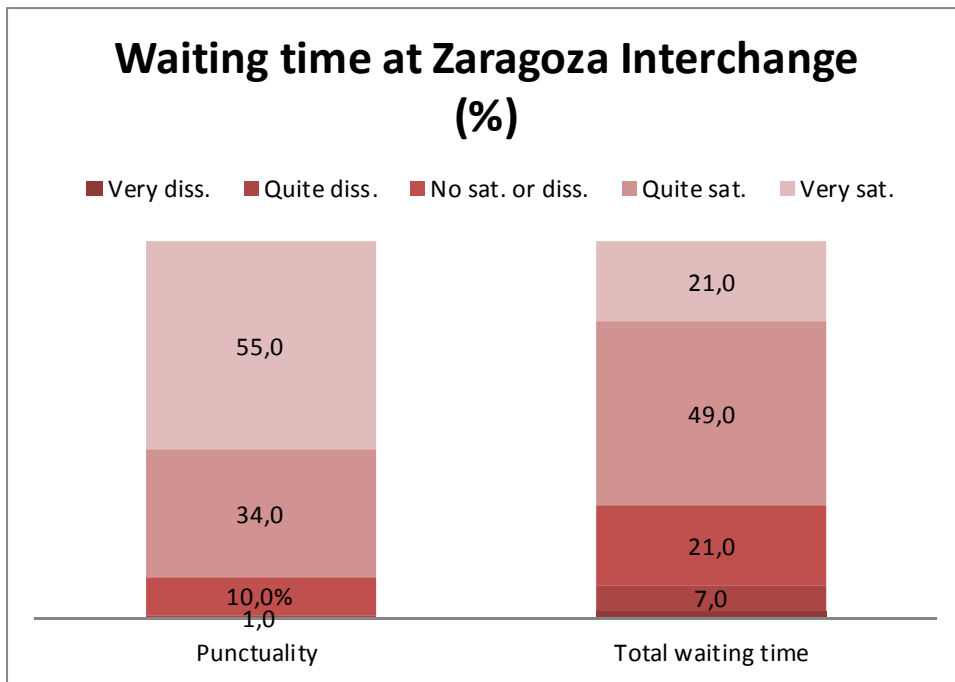


Figure 6.164 Zaragoza Interchange. Satisfaction with waiting time.

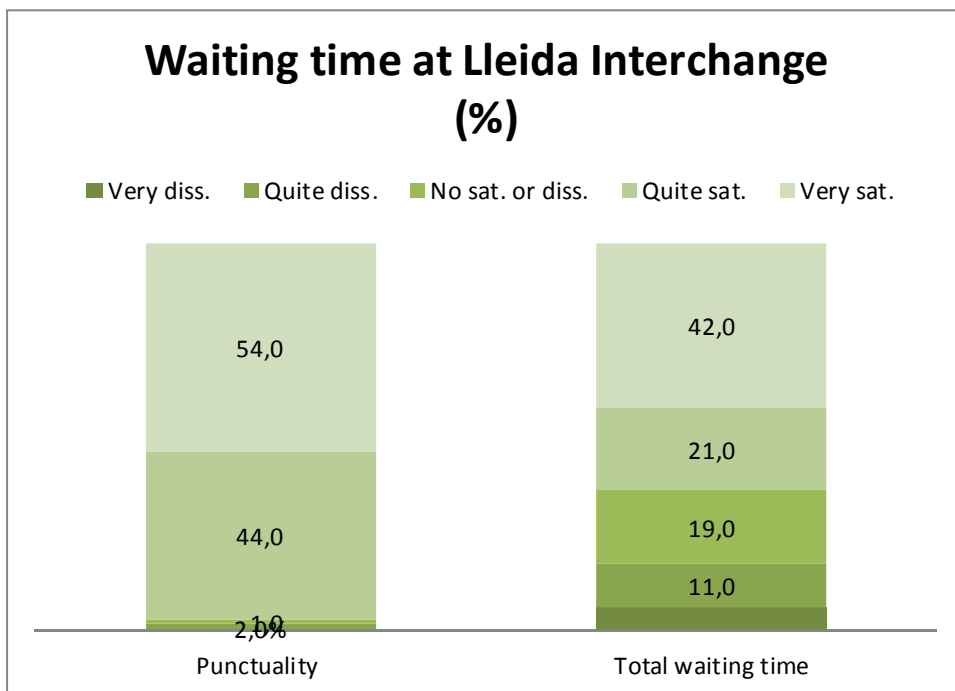


Figure 6.165 Lleida Interchange. Satisfaction with waiting time.

6.3.7.3.3 Trans-boarding time

Trans-boarding time is here understood as total time that passengers spent in the interchange. Despite the high level of satisfaction passengers had with punctuality and waiting time; most of

the respondents were going to spend between 16 and 45 minutes at the interchange (45-50 %), but only 2-3 % due to delays.

Total Time	Zaragoza (%)	Lleida (%)
< 5 min	1,0	2,0
5-15 min	12,0	20,0
16-45 min	48,0	45,0
> 45 min	38,0	33,0

Figure 6.166 Trans-boarding time

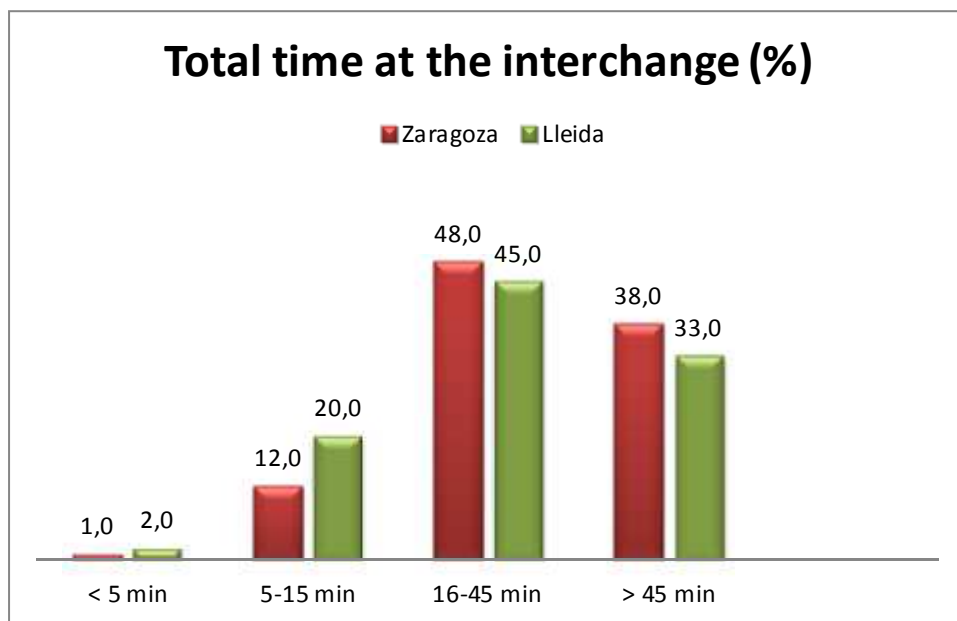


Figure 6.167 Trans-boarding time.

6.3.7.4 Space

In this section space has been considered as an indicator for the quality of the services and has been divided as follows:

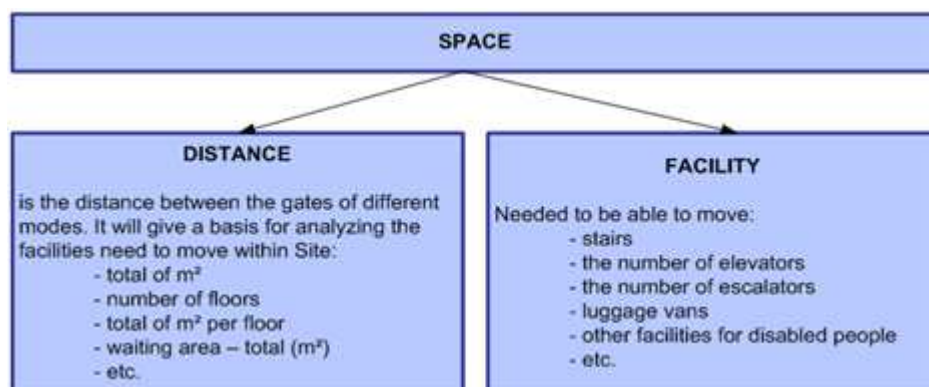


Figure 6.168 Space division.

Regarding space we had to evaluate distance as well as facilities. In order to evaluate both; the first questions were how familiar passengers were with the interchange and how easy had been to find next transport mode.

Respondents had found generally easy to find next transport mode, especially in Lleida. Although knowing that most passengers were familiar with both interchanges (70- 80 % answered they were quite or very familiar) results may not be as good as they seem.

Findability	Zaragoza (%)	Lleida (%)
Very hard	2,0	0,0
Quite hard	5,0	1,0
Neither one	12,0	40,0
Quite easy	37,0	5,0
Very easy	44,0	54,0

Figure 6.169 Findability of next transport mode

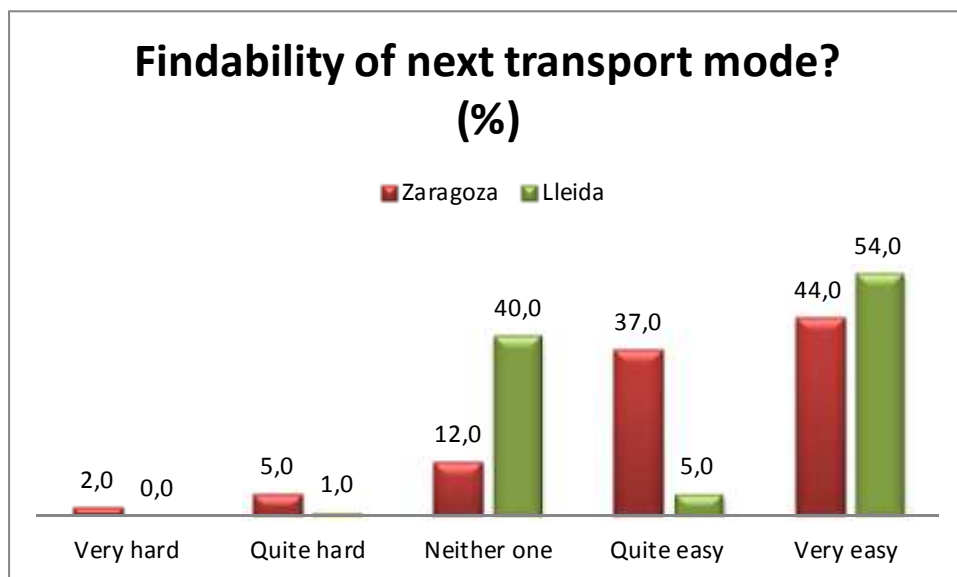


Figure 6.170 Findability of next transport mode.

6.3.7.4.1 Distance

Three aspects about distance have been evaluated: space at station, seating capacity and access to luggage store.

About space at station and seating capacity most passengers feel rather satisfied, and passengers at Zaragoza were much more satisfied than the ones at Lleida.

On the other hand most respondents felt indifferent about access to luggage storage.

Factors about distance

		Very diss.	Quite diss.	No sat. or diss.	Quite sat.	Very sat.
Zaragoza	Space station	2,0	6,0	7,0	34,0	51,0
	Seat capacity	2,0	10,0	11,0	36,0	42,0
	Acc lugg storage	5,0	12,0	34,0	34,0	15,0
Lleida	Space station	9,0	25,0	22,0	36,0	7,0
	Seat capacity	16,	26,0	19,0	34,0	5,0
	Acc lugg storage	18,0	12,0	51,0	15,0	4,0

Figure 6.171 Factors about distance

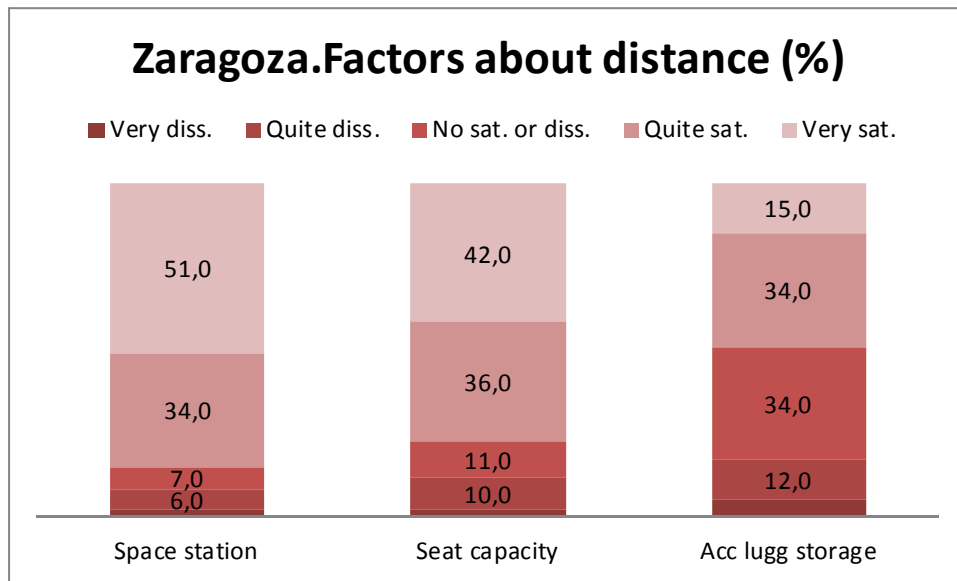


Figure 6.172 Zaragoza Interchange. Satisfaction with distance.

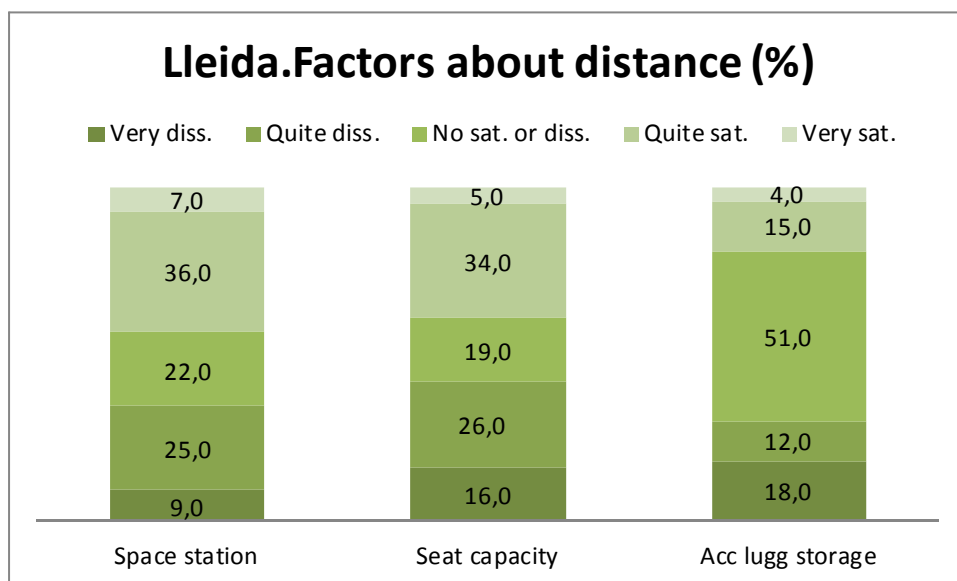


Figure 6.173 Lleida Interchange. Satisfaction with distance.

6.3.7.4.2 Facilities at the site

In this section we analyse facilities by tree questions: the first question passengers had to answer was if they had missed any facility; those who had missed something were asked what was it; and last question was to evaluate the main facilities at the interchange: elevators and escalators.

Very few of the respondents had missed any information (11 % in Zaragoza and 5 % in Lleida).

Out of them most had missed firstly more information and signalling especially at Zaragoza, and a high number at Lleida had also missed more elevators or escalators.

Missing information?	Zaragoza (%)	Lleida (%)
Yes	11,0	5,0
No	89,0	95,0

Figure 6.174 Missing information?

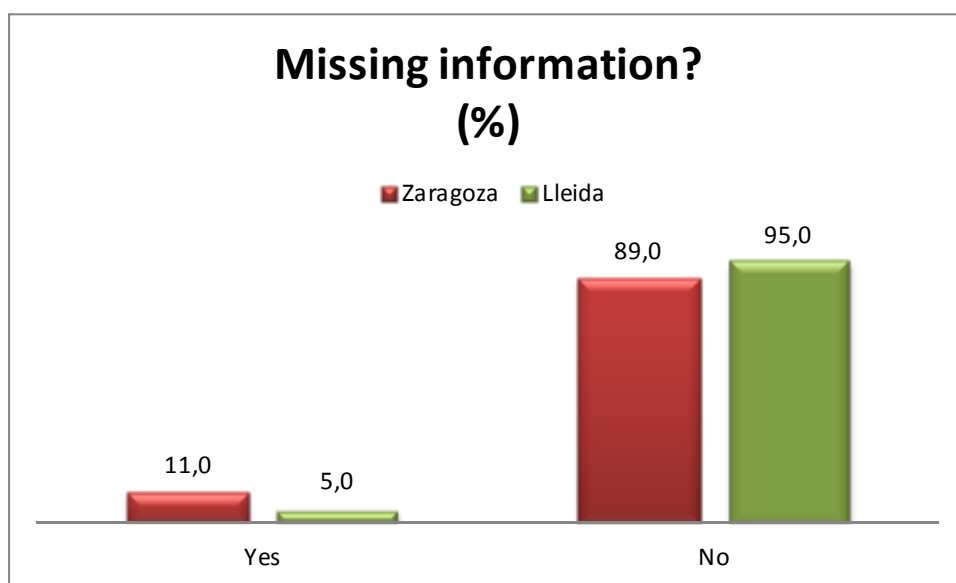


Figure 6.175 Information.

What are you missing?	Zaragoza (%)	Lleida (%)
Signaling/info	88,0	67,0
Access/exit gates	0,0	0,0
Mode connections	8,0	0,0
Elevators/escalators	0,0	17,0
Trolleys	0,0	0,0
Others	4,0	17,0

Figure 6.176 What are you missing?

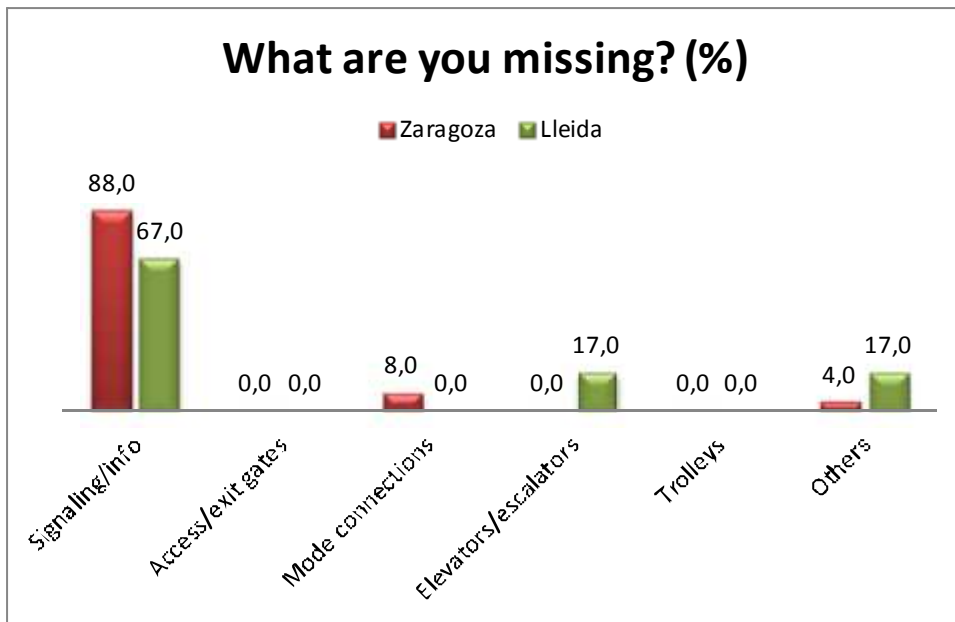


Figure 6.177 Information.

Passengers use mainly escalators at Zaragoza (52 % of the respondents) and walkways at Lleida (used by a 70 % of the respondents).

Use of facilities	Zaragoza (%)	Lleida (%)
Elevators	11,0	2,0
Escalators	52,0	7,0
Walkways	25,0	70,0
Other	12,0	20,0

Figure 6.178 Use of facilities

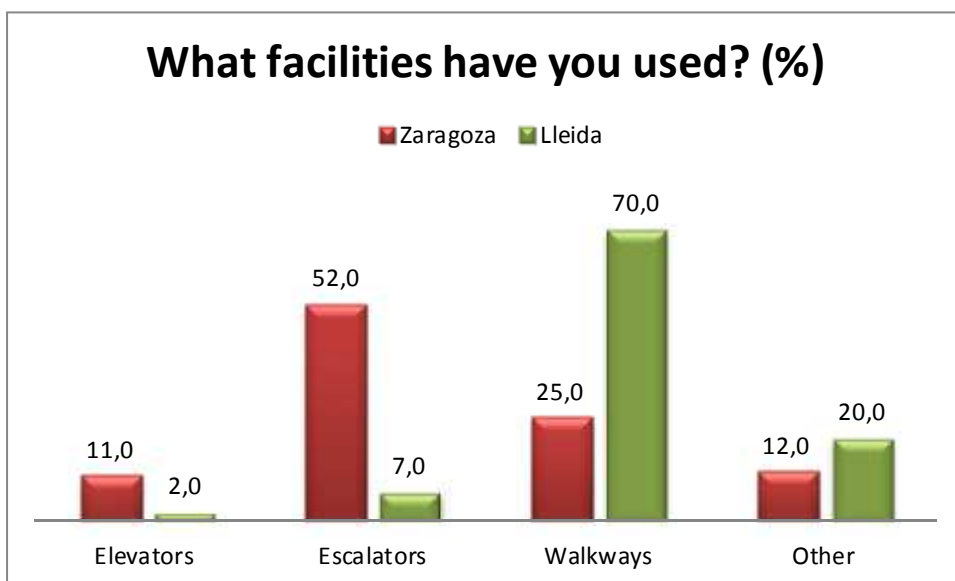


Figure 6.179 Facilities.

Most passengers were very satisfied with all facilities at Zaragoza Interchange, we could not say the same about passengers at Lleida Interchange (there are less facilities and respondents were not very satisfied), although with walkways passengers are quite satisfied.

		Satisfaction with facilities (%)				
		Very diss.	Quite diss.	No sat. or diss.	Quite sat.	Very sat.
Zaragoza	Elevators	0,0	13,0	4,0	22,0	61,0
	Escalators	1,0	7,0	7,0	35,0	50,0
	Walkways	9,0	2,0	14,0	35,0	40,0
	Other	0,0	0,0	54,0	46,0	0,0
Lleida	Escalators	14,0	29,0	29,0	29,0	0,0
	Walkways	1,0	3,0	18,0	32,0	46,0

Figure 6.180 Satisfaction with facilities

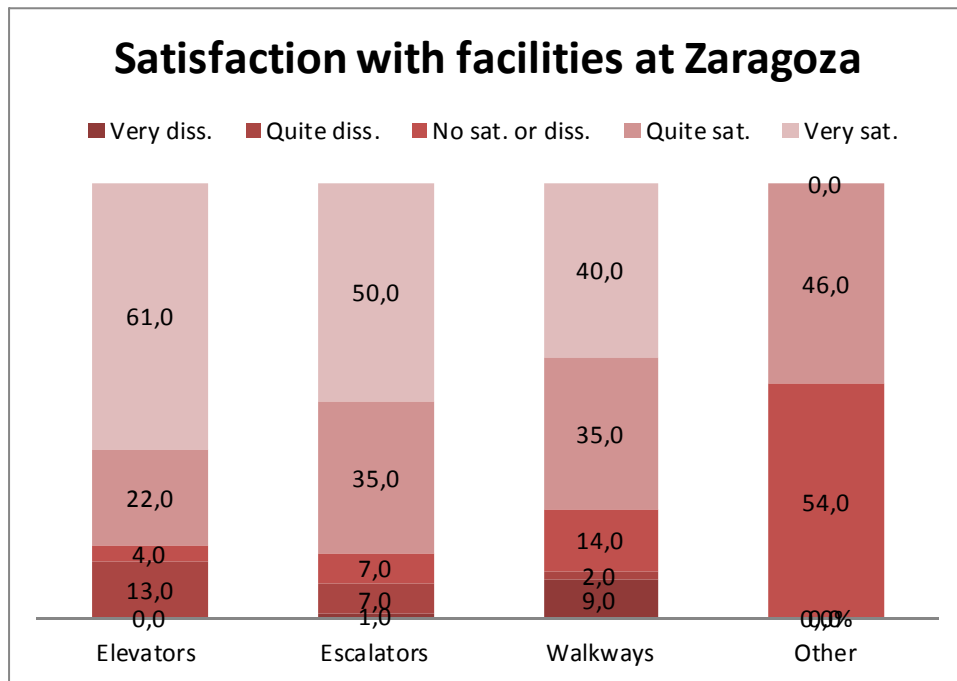


Figure 6.181 Zaragoza Interchange. Satisfaction with facilities.

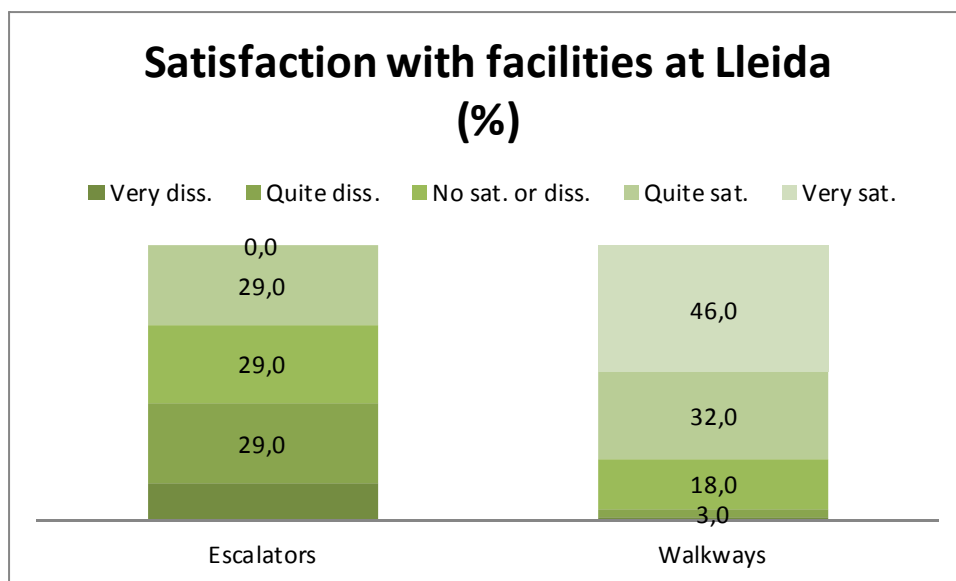


Figure 6.182 Lleida Interchange. Satisfaction with facilities.

6.3.7.5 Information, Ticketing and Check-in Services

Regarding information, ticketing and check-in, passengers were asked to evaluate the existing systems. Answers were quite unanimous and most passengers seemed to be quite satisfied with all aspects about information and ticketing services at both interchanges.

		Information and ticketing services (%)				
		Very diss.	Quite diss.	No sat. or diss.	Quite sat.	Very sat.
Zaragoza	Information Signs	3,0	9,0	19,0	51,0	19,0
	Information counters	4,0	7,0	29,0	36,0	24,0
	Tickets machine	5,0	5,0	29,0	40,0	21,0
	Tickets at counters	2,0	6,0	18,0	43,0	31,0
	Counters' personnel	3,0	4,0	14,0	41,0	37,0
	Reschedule tickets	7,0	7,0	15,0	43,0	29,0
Lleida	Information Signs	10,0	21,0	17,0	32,0	20,0
	Information counters	3,0	6,0	13,0	55,0	23,0
	Tickets machine	9,0	4,0	13,0	52,0	22,0
	Tickets at counters	5,0	3,0	11,0	45,0	36,0
	Counters' personnel	4,0	7,0	7,0	44,0	38,0
	Reschedule tickets	6,0	15,0	12,0	35,0	32,0

Figure 6.183 Information and ticketing services

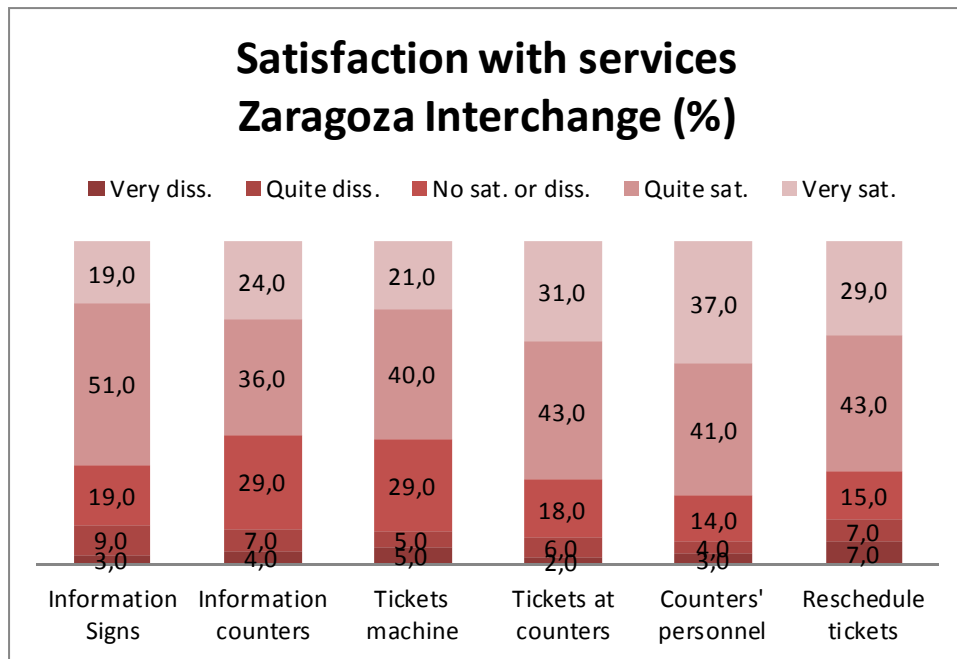


Figure 6.184 Zaragoza Interchange. Satisfaction with services.

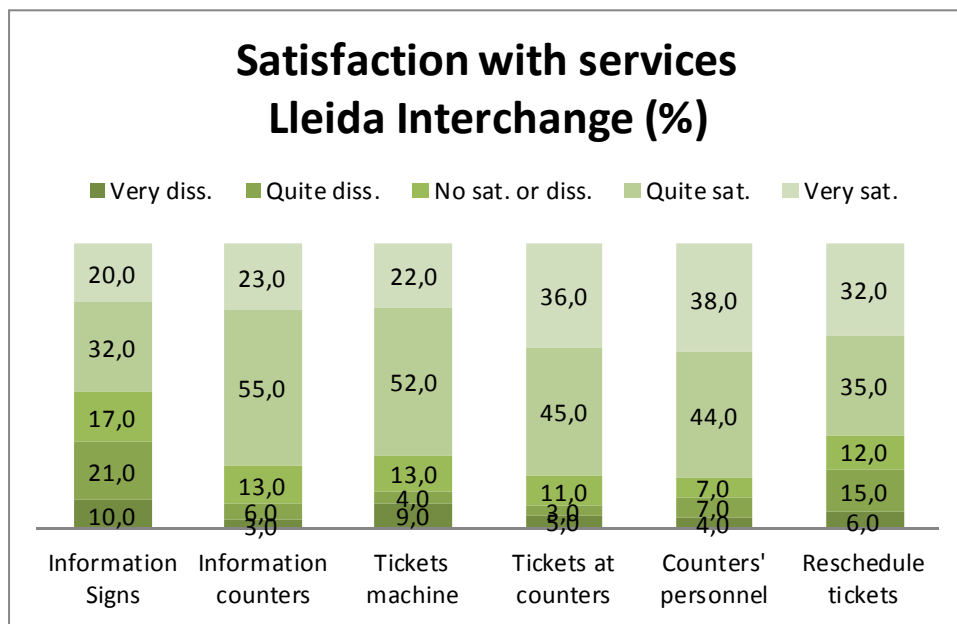


Figure 6.185 Lleida Interchange. Satisfaction with services.

6.3.7.5.1 Information

The more important aspect about information is if passengers would have liked to receive more information.

Regarding this, most passengers had not noticed a lack of information about the interchange or alternative modes, although passengers at Zaragoza were worse informed than passengers at Lleida.

Lack of information? (%)		Yes	No
Zaragoza	About the interchange	13,0	87,0
	About alternate modes	12,0	88,0
Lleida	About the interchange	4,0	96,0
	About alternate modes	6,0	94,0

Figure 6.186 Lack of information

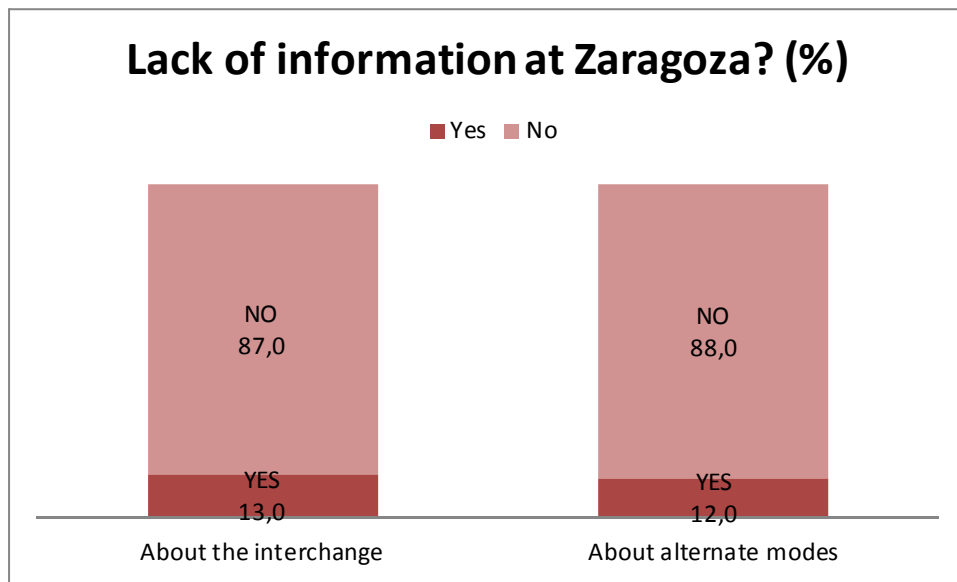


Figure 6.187 Zaragoza Interchange. Information.

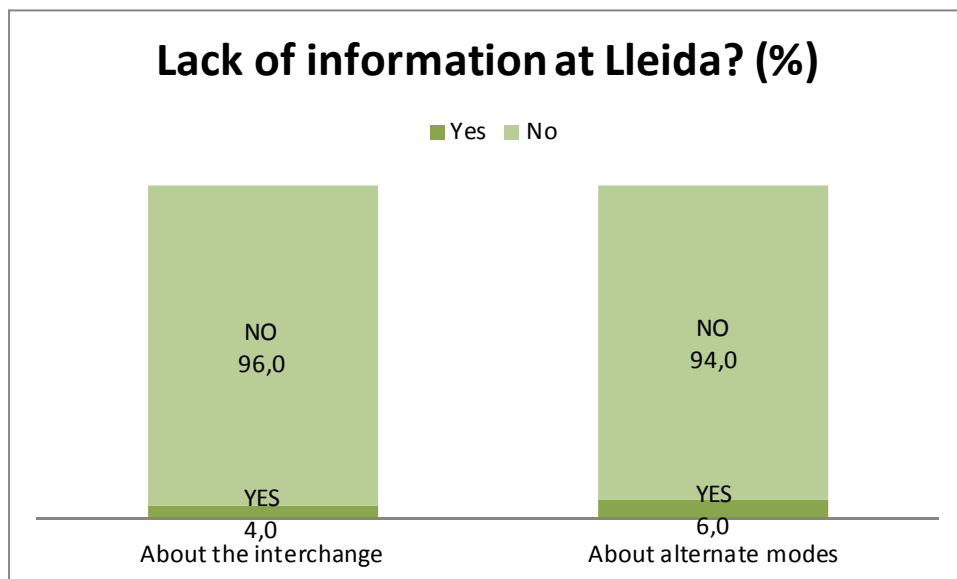


Figure 6.188 Lleida Interchange. Information.

Those passengers who would have liked to receive more information, missed mainly modes schedule and information in the interchange, while none of the respondents missed WIFI.

What have you missed?	Zaragoza (%)	Lleida (%)
Modes schedule	21,0	67,0
Info in the interchange	45,0	33,0
Info services	34,0	0,0
WIFI	0,0	0,0

Figure 6.189 Information

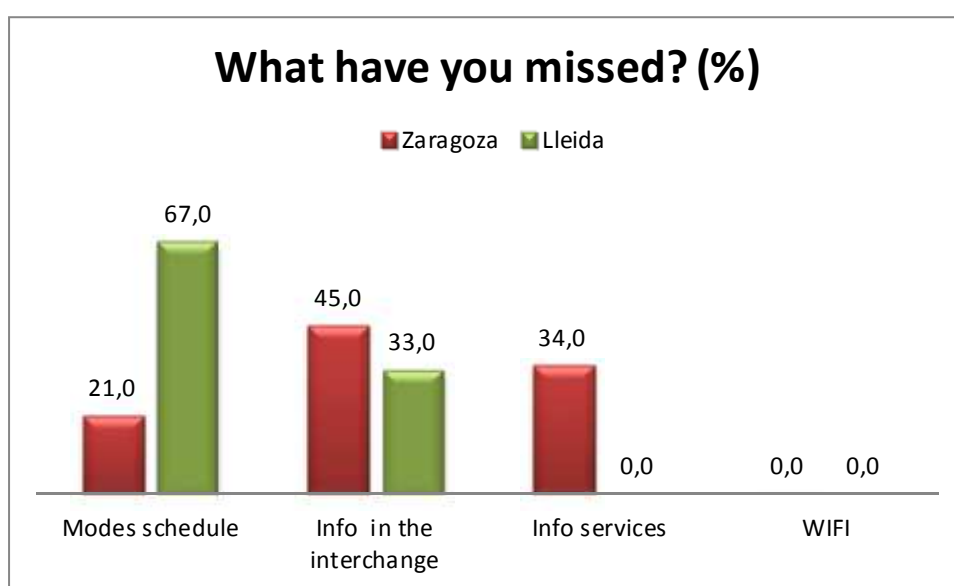


Figure 6.190 Information.

6.3.7.6 Added value at the site

Firstly we asked the passengers to give their opinion of different aspects about added value.

Passengers were quite satisfied with almost all aspects with some exception; they felt indifferent about services and childcare at Zaragoza or shopping at Lleida, and very dissatisfied with childcare in Lleida.

		Added value (%)				
		Very diss.	Quite diss.	No sat. or diss.	Quite sat.	Very sat.
Zaragoza	Shopping	6,0	22,0	28,0	31,0	12,0
	Services	4,0	23,0	41,0	25,0	7,0
	Access to toilets	3,0	7,0	19,0	45,0	26,0
	Cleaning toilets	4,0	10,0	25,0	41,0	21,0
	Cleaning station	0,0	4,0	16,	44,0	36,0
	Access lounges	2,0	1,0	13,0	50,0	33,0
	Access other modes	3,0	11,0	19,0	47,0	21,0

	Ventilation	6,0	11,0	18,0	44,0	21,0
	Safety/security	1,0	6,0	22,0	44,0	28,0
	Disabilities people	5,0	15,0	20,0	39,0	20,0
	Childcare	24,0	22,0	35,0	12,0	8,0
Lleida	Shopping	9,0	27,0	34,0	23,0	8,0
	Services	33,0	0,0	0,0	33,0	33,0
	Access to toilets	2,0	7,0	29,0	33,0	29,0
	Cleaning toilets	8,0	24,0	24,0	35,0	10,0
	Cleaning station	1,0	1,0	7,0	66,0	25,0
	Access lounges	0,0	6,0	18,0	34,0	41,0
	Access other modes	2,0	14,0	13,0	26,0	45,0
	Ventilation	3,0	16,0	16,0	43,	22,0
	Safety/security	0,0	3,0	16,0	53,0	29,0
	Disabilities people	26,0	19,0	9,0	19,0	28,0
	Childcare	91,0	9,0	0,0	0,0	0,0

Figure 6.191 Added value

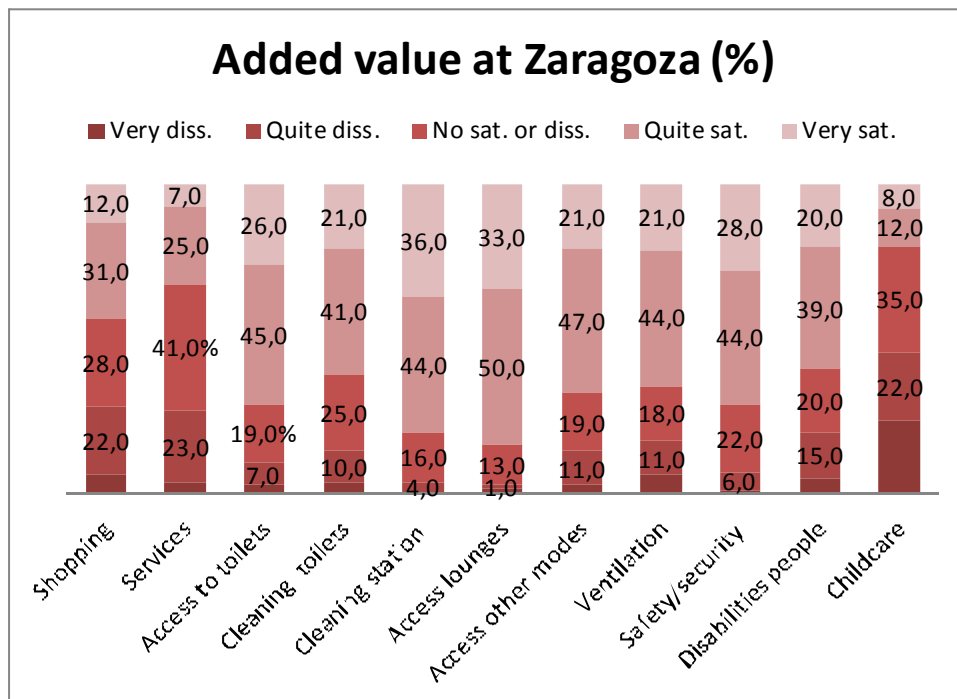


Figure 6.192 Zaragoza Interchange. Satisfaction with added value facilities.

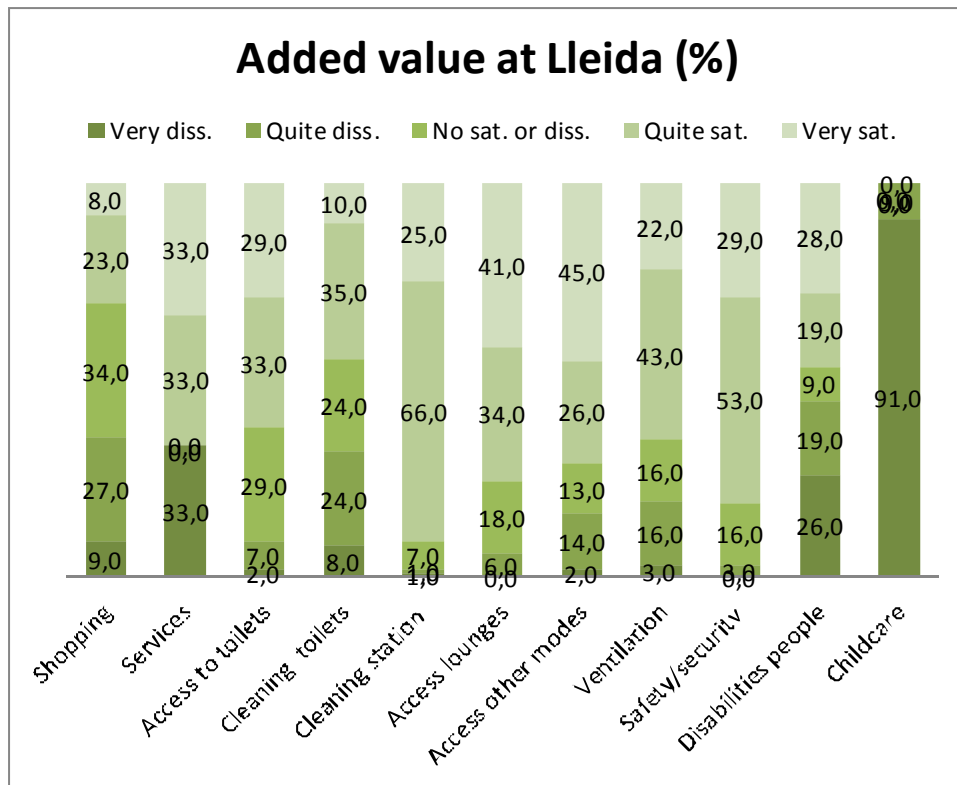


Figure 6.193 Lleida Interchange. Satisfaction with added value facilities.

After giving their opinion, we asked what should be developed to make the interchange more efficient. Despite the bad opinion passengers had about childcare facilities, very few thought that to improve them is a priority. On the other hand a high number of respondents said services should be more developed at Zaragoza while passengers at Lleida requested to develop WIFI.

Improvements	Zaragoza (%)	Lleida (%)
Services	27,3	11,1
Shops	23,6	3,7
Disable people	0,9	0,0
Childcare	0,0	0,0
Luggage store	0,0	29,6
More info	22,7	3,7
Ventilation	7,3	0,0
Wi-fi	10,9	44,4
Others	7,3	7,4

Figure 6.194 Added value - improvement

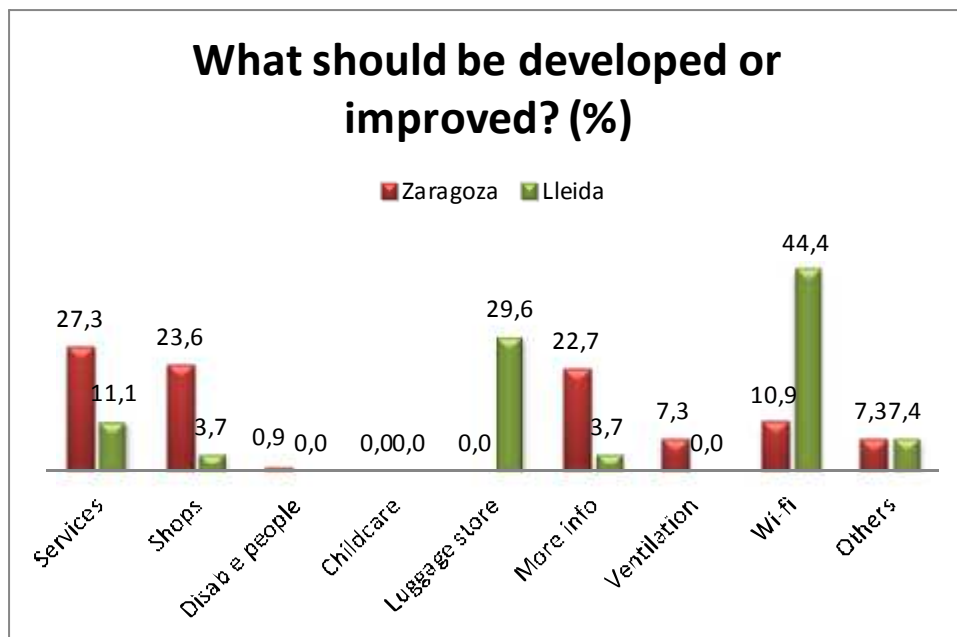


Figure 6.195 Added value improvement

6.3.8 Analysis for improvement of interconnectivity

6.3.8.1 Comparison between customers and stakeholders

6.3.8.1.1 Travel demand/Passenger flow

Regarding travel demand versus passenger flow both stakeholders and customer groups show a high level of satisfaction (a high percentage were very or quite satisfied)

6.3.8.1.2 Time

The Manager of railway stations of the area of Zaragoza believes that time is not enough optimised, in the bus operator manager's opinion especially waiting time should be reduced.

However passengers are quite satisfied with this issue especially with punctuality.

6.3.8.1.3 Space

Regarding space, stakeholders believe there are physical barriers in both cases (in Lleida too much distance, in Zaragoza a fence preventing the passage) among railway stations and bus stations, but passengers didn't show complaints about it.

6.3.8.1.4 Information, Ticketing and Check-in Service

Regarding this issue, Terminal Managers of both interchanges believe that there is a lack of information, especially of integrated information (bus and train)

According the surveys passengers missed information (88 % at Zaragoza and 67 % at Lleida), rather than access or escalators.

6.3.8.1.5 Added value at the site

For the Manager of railway stations of the area of Zaragoza, the main complaints are those regarding accessibility and comfort.

Passengers complained about facilities for childcare, but most of them were satisfied with aspects of added value.

6.3.8.2 Validation of findings in WP3/WP4

From the information gathered through WP3 and WP4 (stakeholders' surveys, customers' satisfaction surveys, and "free" questions analysis), it could be stated that there are five key barrier clusters, relevant for all modes and stakeholders

- Need for passenger to receive integrated information
- Need to remove physical barriers between different modes (specially between train and bus)

- At Zaragoza Station, the physical barrier is a fence separating railway station and bus station
- At Lleida Station, there is too much distance (1,7 km) and bad connections between railway station and bus station
- Need for a Terminal Manager less involved with railway services
- Need for Local Transport Authorities to play a more important role on the Management of the stations as well as on the decision making process.
- Coordination and cooperation between different Transport Operators; short and long distance and bus and rail

On the other hand, from the stakeholders' perspective, barriers show specific patterns, as follows:

- Decision Makers and Terminal Managers focus the attention on facilities and comfort at Station, but not on stimulating intermodality.
- Decision Makers and Terminal Managers are too involved with railway services (the company in charge of the Stations is the railway infrastructure owner in Spain), and do not pay enough attention to bus services.
- Local Transport Authorities do not make decisions at Stations, and are not involved in the Management. Therefore public short distance modes are not considered in design.
- Transport Operators focus their attention on providing a good service to users during the trip but they do not provide information about other modes (there is not even integrated information between short distance and long distance modes); therefore they do not foster transfer.
- Finally, the User Associations claim for the availability of the intermodal services and information.

It is interesting to note that there are no significant correlations between barrier clusters and mode combinations, and that rail and bus interfaces are separated in terms of cooperation among operators.

6.3.8.3 Missing links and new Value Proposition

After gathering and analyzing all the information above, according to the Gap analysis carried out by WP2, it could be stated that in Zaragoza-Lleida stations low integration between transport services has been identified, in short the gap analysis carried out in the analytical process.

Particular problems for each case of study can be classified into three groups: bad information or signalling, lack of physical integration and non adequate relationship between agents.

(WP2-WP5) in Zaragoza-Lleida stations a bad intermodal transfer has been identified, due to the lack of integration between the long distance and the short distance services.

In short, the gap analysis carried out in the analytical process.

6.3.8.3.1 Zaragoza

6.3.8.3.1.1 Bad information and signalling

At Zaragoza Station, services provided by long distance buses, long distance trains and public local/regional buses (six lines with good frequencies) and trains is quite good and complete, but there is no integrated information about all existing modes at Station:

- At the information point there is information about train services and at the bus station, staff inform passengers about long distance bus service. For local buses timetables and schedules users must go outside the station (bus stops).
- Real-time displays at station are quite good and frequent for railway services; poor for long distance/ regional buses; and nonexistent for local buses.
- Information about railway services and long distance/ regional bus services is available in different websites, and none of them provide information about local buses schedules, time tables or routes can be found.

6.3.8.3.1.2 Physical Integration

There is a physical barrier (a fence) separating railway station and bus station, therefore despite both stations are adjacent, passengers have to walk a long way to go from one to another; this affects intermodality between long distance bus and train (according to the surveys only a 2,1 % of the respondents to the surveys did this transfer)

There are car parks at the train station side, and as a consequence of this physical barrier, the street facing the bus station side is congested, cars are illegally parked which affects to local buses and taxi services.

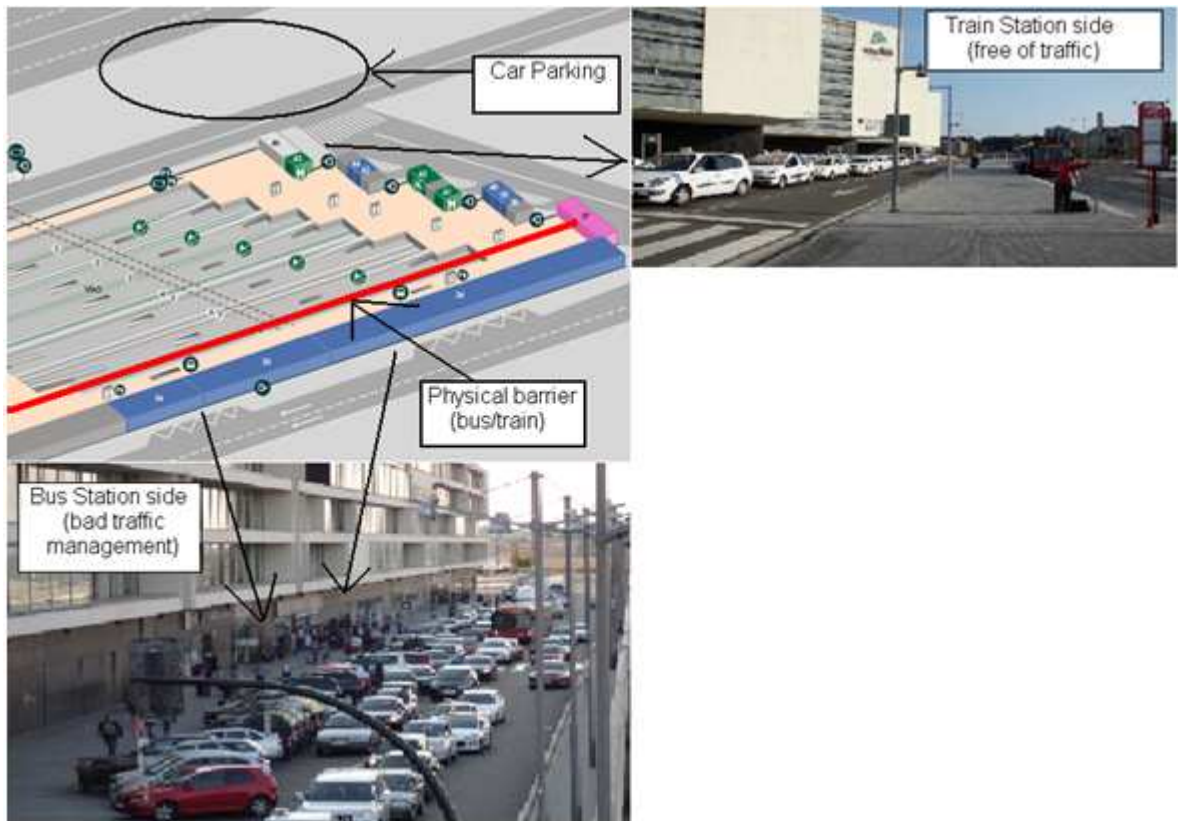


Figure 6.196 Physical barrier. Consequences.

6.3.8.3.1.3 Relationships between agents

- The Terminal Manager, as well as Decision makers, are appointed by Adif, the owner of the railway infrastructure in Spain, and both are too focused into railway services, not in intermodality between train and long distance/regional buses, and not even between train and public local buses.
- Local Transport Authorities are not involved in station management, or decision making process.
- There is no collaboration between bus and train Transport Operators.

6.3.8.3.2 LLeida

6.3.8.3.2.1 Bad information and signalling

At LLeida Station, there is no information about other services other than railway services:

- At the information point, as well as in the web-site; there is only information about routes, timetables and schedules of railway services (there is not even information about public local buses, with stop in front of the station)
- Real-time displays at station are quite good but only for railway services.

6.3.8.3.2.2 Physical barriers

- Despite the fact that most passengers arrive to the station by car (42 % of the respondents went by car), there is no parking at the station.
However, a 600 car places parking will be constructed. It would be necessary to give priority to this facility.
- Four bus lines stop in front of Lleida Station, but frequencies are very uneven (depending on the time and the line) ranging from 15 to 40 minutes, providing a very poor service of public local buses (compared to expected by train users, especially HSR passengers who have a high value of time).
This should be improved, especially in those lines connecting the bus station (three of them).

6.3.8.3.2.3 Relationships between stakeholders

- The Terminal Manager, as well as Decision makers, are from Adif, the owner of the railway infrastructure in Spain, and both are too focused into railway services, and not in intermodality between train and public local buses.
- Local Transport Authorities are not involved in station management, or decision making process.

6.3.9 Actions for improvement of interconnectivity

6.3.9.1 Proposal

In general terms from the analysis carried out through the different surveys, to overcome the barriers existing in the current model, different actions should be needed. In this paragraph we will describe feasible actions to overcome barriers and to improve the intermodal transport service, presenting and justifying a new proposal.

6.3.9.1.1 Information and signalling (Zaragoza- Lleida)

- There should be **integrated information** about all modes at stations. All the information should be **placed in common** in the existing **information points at stations** (where nowadays only information about railway services is available), and in a **web- site** for each station.
- There should be also **real- time displays** for all modes at station.
- Long distance modes should foster the use of public local and regional buses. We propose agreements between long distance and short distance operators to **provide information about public local and regional buses** (timetables, schedules and routes) **when acquiring long distance tickets**.

6.3.9.1.2 Physical integration (Zaragoza)

- **Accesibility between bus and train stations should be improved** (in terms of time, space and comfort).
This **fence** could be overcome by an **underpass** or a **overpass**.
- Parking management in the street facing the bus station should be improved (cars badly parked affect to congestion and therefore to bus and taxi services)
We propose some **kind of surveillance to enforce car drivers follow regulations**.

6.3.9.1.3 Physical integration (Lleida)

- The lack of car places and the high number of passengers arriving by car make the future **construction of the new parking lots** a **priority**.
- The **frequencies and service of local buses with stop in front of the station** is an issue to be *improved* (nowadays frequencies are too uneven, and the service is poor), and at least some of the four existing lines with stop in front of the Station should have **regular schedules and time tables**, for a more **reliable service; especially those with stop at the Bus station** (1,7 km separate both stations)

6.3.9.1.4 Relationships between stakeholders (Zaragoza-Lleida)

- **Local Transport Authorities should be more involved in Terminal Manager and Decision Makers** (both from Adif) **activities**; in order to promote the use of public local transport modes in short-long distance intermodality.

For this, **some relevant staff for station management** should be **appointed by local transport authorities**.

- All **Transport Operators** and **Terminal Managers** should collaborate and coordinate their activities in order to:
 - foster transfer and **provide a good service to users** during the **whole trip; including transfer** as a very important step of it.
 - **To ease transfer** between **long distance bus** and **long distance train**.

6.3.9.2 *Description of proposed service using the concept of Agents*

6.3.9.2.1 Objectives and Goals

a) Decision Makers and Terminal manager

As surveys and interviews have evidenced the main objectives of Zaragoza-Lleida station decision makers' are focused on fostering the use of HOV trains by facilitating the access to the station. In such a case, the main obstacle is the cooperation with the local transport authorities in order to coordinate the schedules with the local public transport, to facilitate the last mile.

b) Transport Operators

The public train operator RENFE (who operates on private basis), focus its interest on maximizing their benefit. To do so, they must attract people from private modes (car and taxi mainly)

Public transport operators are focused on reducing costs (to benefit society), long distance bus operators are also focused on reducing costs because their customers demand it.

c) Users

Bus users' objectives regards mainly to minimize costs and reduce transfer time.

Train users' objectives regards mainly to minimize travel time and to maximize comfort.

6.3.9.2.2 Strategies

In this paragraph we deal with possible actions to be taken by the agents to achieve its objectives through feasible and realistic actions.

a) Decision Makers/terminal manager (ADIF)

Fostering coordination with local buses and trains to reach short distances could be achieved through agreements between both authorities (ADIF and Local Transport Authorities)

Terminal Manager should assure coordination and collaboration between bus and railway operators.

b) Bus/train Operators

Collaboration between bus and train operators could be translated into integrated information and schedules.

To attract more users to buses and commuter trains in order to maximize benefits a good coordination between agents is needed. Otherwise people will continue using taxis to cover the last mile (or any short distance)

6.3.9.2.3 Interactions between agents and graphical representation

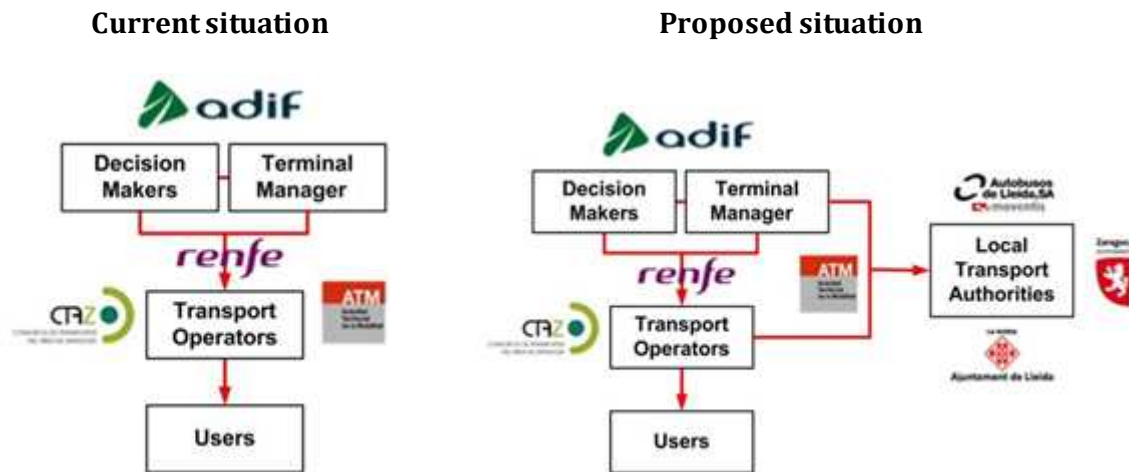


Figure 6.197 Interaction between agents in current and proposed situation

Terminal Manager and **Decision Makers** working together with **Local Transport Authorities** and coordinate **Transport Operators**

Terminal Manager manages the Stations, defines contract agreements, and enforce regulations to be fulfilled by **Transport Operators**.

Transport Operators pay operating fees to **Terminal Managers** for the use of infrastructures

Transport Operators and indirectly **Terminal Manager** provide service to users.

6.3.9.3 *Functions and Indicators to show enhancement*

6.3.9.3.1 Functions of validation

6.3.9.3.2 Integration and signalling (Zaragoza-Lleida)

The lack of information makes people spending more time at the interchange looking for the next transport mode, and also makes some travellers going by taxi or by car, more comfortable and more expensive; but do not require any special knowledge about schedules, combinations or maps.

Therefore an improvement on the information and signaling at the interchange would reduce the time spent at the Interchange and would induce some passengers getting there by public transport modes, hence saving money.

If information of buses and trains would be provided together, more passengers could transfer between long distance bus and long distance train.

6.3.9.3.3 Physical integration (Zaragoza)

The improvement of access between railway station and bus station should foster intermodality between both of them.

If illegal parking was removed from the street facing the bus station; traffic management would be improved and therefore frequencies on public local buses and taxis would also get better so waiting time would decrease. Finally, around the station, the level of noise, congestion and pollution would be reduced.

6.3.9.3.4 Physical integration (Lleida)

All passengers arriving at the station by car (most of them) have no specific place to park, and parking on the street, it is therefore necessary to provide parking lots.

Train users at Lleida station have more or less the same profile than train users at Zaragoza, so if frequencies and services at Lleida were at least as these existing at Zaragoza, the percentage of passengers using public local buses would be, at least, the same it is in Zaragoza. (33 % instead of 21 %); and this could even be improved.

6.3.9.3.5 Stakeholders relationships (Lleida-Zaragoza)

If local transport Authorities were more involved in the management of the stations and in the decision making process, improvement actions would be focused on promoting the use of public local buses.

If terminal Managers worked together with transport operators; the service would be improved during the whole trip, including transfer.

6.3.9.3.6 Indicators of validation

6.3.9.3.7 Zaragoza

PROPOSALS		INDICATORS	RESULTS	POTENTIAL DEMAND
Information and signaling	<ul style="list-style-type: none"> • Integrated information about all modes at Station (bus/train and short /long distance): <ul style="list-style-type: none"> - Real-time display at Station - Information point at Station - Web site of the Station • Information about short distance bus and trains altogether provided with long distance modes ticket 	Time spent at the Station (in min)	Reduction	<ul style="list-style-type: none"> • Mostly passengers from outside Zaragoza • Mostly passengers arriving by taxi or car • New passengers attracted by transfer facilities
		Percentage of passengers travelling on public local transport modes	Increase	
		Money spent in the whole trip (↑ PT)	Reduction	
		Number of users (passengers/year)	Increase	
		Percentage of travelers transferring between long distance bus to long distance train	Increase	

Physical integration	<ul style="list-style-type: none"> Elimination of the physical barrier between railway station and bus station (by an underground step or a top step) 	Number of users (passengers/year)	Increase	<ul style="list-style-type: none"> New passengers attracted by transfer facilities Satisfaction of passengers who transfer between long distance buses and long distance trains 	
		Percentage of travelers transferring from long distance bus to long distance train	Increase		
	<ul style="list-style-type: none"> Improvement in traffic management around the Station (to enforce car drivers follow regulations) 	Waiting time for local buses, taxis and car	Reduction		<ul style="list-style-type: none"> All
		Level of congestion	Reduction		
Level of pollution		Reduction			
Relationships between agents	<ul style="list-style-type: none"> Local Transport Authorities more involved in Terminal Manager and Decision Makers (both from Adif) activities; in order to promote the use of public local transport modes in short-long distance intermodality. 	Number of relevant staff for station management; occupied by personnel from Local Transport Authorities	Increase (nowadays non-existing)	<ul style="list-style-type: none"> All New passengers attracted by simplicity of transfer Satisfaction of passengers who already transfer between long distance buses and long distance trains 	
		Number of initiatives (improvement actions) focused on the use of public local transport at the Station	Increase		
	<ul style="list-style-type: none"> Terminal Managers less focused on rail services and more focused on transfer at Station Collaboration between Terminal Managers, and bus and rail Transport Operators; in order to: <ul style="list-style-type: none"> Foster transfer between long distance bus and long distance train Provide good service to users during the whole trip (including transfer) 	Number of meetings between Terminal managers and Transport Operators	Increase		
		Number of users (passengers/year)	Increase		
		Percentage of travelers transferring from long distance bus to long distance train	Increase		

Figure 6.198 Indicators of validation Zaragoza

6.3.9.3.8 Lleida

PROPOSALS	INDICATORS	RESULTS	POTENTIAL DEMAND	
Information and signaling	<ul style="list-style-type: none"> Integrated information about all modes (bus/train and short/ long distance): <ul style="list-style-type: none"> Real-time display at Station Information point at Station Web site of the Station Information about short distance bus and trains altogether provided with long distance train tickets 	Time spent at the Station (in min)	Reduction	<ul style="list-style-type: none"> Mostly passengers from outside Lleida Mostly passengers arriving by taxi or car New passengers attracted by transfer facilities
		Percentage of passengers travelling on public local transport modes	Increase	
		Money spent in the whole trip (↑↑ PT)	Reduction	
		Number of users (passengers/year)	Increase	
Physical integration	<ul style="list-style-type: none"> Priority to the construction of parking lots (it is already in process) 	Number of users (passengers/year)	Increase	<ul style="list-style-type: none"> All Satisfaction of passengers who already go by car
		Time spent at the Station (↓↓ cars badly parked, ↑↑ traffic management, ↑↑ services of buses, taxis...)	Reduction	

	<ul style="list-style-type: none"> Improvement of frequencies and services of the four local bus lines with stop at Lleida Train Station (especially those with stop at bus station (1,7 km separate the both stations)). 	Number of users (passengers/year)	Increase	<ul style="list-style-type: none"> New passengers attracted by a better service of public local buses New passengers attracted by long distance bus services Satisfaction of passengers who already use local buses
		Waiting time (in min)	Reduction	
Relationships between agents	<ul style="list-style-type: none"> Local Transport Authorities more involved in Terminal Manager and Decision Makers (both from Adif) activities; in order to promote the use of public local transport modes in short-long distance intermodality. 	Number of relevant staff for station management; occupied by personnel from Local Transport Authorities	Increase (nowadays non-existing)	<ul style="list-style-type: none"> All
		Number of initiatives (improvement actions) focused on the use of public local transport at the Station	Increase	
	<ul style="list-style-type: none"> Terminal Managers less focused on rail services and more focused on transfer at Station Collaboration between Terminal Managers and Transport Operators; in order to: <ul style="list-style-type: none"> Provide good service to users during the whole trip (including transfer) 	Number of meetings between Terminal managers and Transport Operators	Increase	
		Number of users (passengers/year)	Increase	

Figure 6.199 Indicators of validation Lleida

6.3.9.3.9 Methods and tools

There should be a quality survey among passengers carried out by the Terminal Managers. With the information collected, statistics about some relevant issues should be produced to evaluate if improvements and changes are working as expected.

Indicators calculated by these surveys and statistics could be:

Total time spent at the interchange, and **waiting time**

Percentage of passengers using each mode from those offered at the stations

Money spent in travelling by passengers

Indeed, the frequency in carrying out these surveys is an indicator by itself:

Number of surveys or quality test per year

This indicator gives an idea to the Terminal Managers about the need for improvement the services provided to users. They should be done at least once a year.

Flow measures should be calculated at the Interchange, also under the responsibility of the Terminal Manager.

These flow measures would allow calculating:

Number of passengers per year using the station.

Percentage of passengers per mode from those offered at the interchange

In Zaragoza, around the station, facilities are needed to be measured:

Congestion (**number of cars per minute**)

Noise (**decibels**)

Air contamination (**emissions**)

We could evaluate the relationships between stakeholders by means of surveys among the Terminal Manager, Decision Makers and Managers of the transport operators companies, asking about:

Number of staff managers appointed by **the local transport authorities**.

Number of meetings per year among Decision Makers, Terminal Manager and Transport Operators.

Improvement actions or decisions focused on the use of public local transport at the station.

6.3.9.4 *Demonstration and Evidence of Improvement*

Improvement actions should be translated into the following results:

- Flow measures should yield a major number of passengers per year using the stations.
- The distribution of passengers between short distance modes would change: more passengers would use public local and regional modes because of the better information.
- Facilities installed to measure comfort should help to reduce emissions and decibels as well as improve congestion, because of the improvement of traffic management. Surveys among the passengers should demonstrate also an increase in the user's satisfaction levels.
- Passengers should spend less time at the stations and save money in the whole trip since it would be easier to access public transport modes due to the improvement of the information provided.
- There should be some relevant staff in station management.
- Stakeholders (Terminal Managers and transport Operators) should hold meetings as frequently as possible, to attend passengers needs and requirements, to provide a good service during the whole trip, including transfer.

All decisions and improvements should be translated into more satisfied users, and surveys should allow checking it.

6.4 Gare de Oriente, Portugal

The case study here presented refers to the connections from the Portuguese north rail-line (Linha do Norte) to small cities nearby, in the Greater Lisbon area. Nowadays, connections to these small cities are provided by bus from Lisbon although rail stations in north rail-line could represent a closer starting point for these cities.

It was our belief that there could be enough passengers whose final destination is a city geographically near from a rail station in the north rail-line that could justify the creation of new transport connections from those railway stations, instead of having to travel (southward) by rail till Lisbon and take the bus there (northward) to those small cities.

Our motivation was to check whether it would be possible to provide better transport service to those rail passengers in the final link to their destinations, without affecting the railway service on a negative way.

6.4.1 Main features of the site

Linha do Norte (North rail-line in English) is the main railway line in Portugal. This line connects the two main Portuguese cities: Lisbon and Oporto. In its 314 km, it crosses some other cities, for example Vila Franca de Xira, Santarém, Coimbra, Aveiro, Gaia and Oporto (see Figure 6.200). It is the backbone of the Portuguese railway system for freight and passengers, running daily hundreds of wagons of both types.



Figure 6.200 – Location of the North rail line

The most emblematic and important railway station in the north rail-line is Gare do Oriente Intermodal Terminal, in Lisbon. This terminal is located some 10 km away from the city center and was design by Santiago Calatrava at the time of the 1998 World Exhibition. The terminal is located in Parque das Nações, in the Noth-Eastern area of Lisbon. The surroundings are composed by business centers, residential areas (around 15.000 residents), a mall, bars and restaurants, museums, and art galleries. Figure 6.201 below presents an overview of this station.



Figure 6.201 – Overview of Gare do Oriente Intermodal Terminal

Gare do Oriente is the largest passenger interchange in Portugal. It gathers subway, short and long distance rail, taxis and local, suburban and long-distance bus transport services. There are also rent-a-car services at the site and an underground parking lot. It has five levels: one for the subway, one for the parking lot, terrain level with buses and taxis, a level with train waiting areas and ticket sells, and an up level with train lines. Figure below shows two of the levels.

Data from 2008 show that this terminal served 75 Million passengers per year. With the extension scheduled (High Speed Rail - HSR integration) it is expected to reach the mark of 90 Million passengers per year. Terminal security is provided by a companie named Prestibel that operates 24 hours a day with video surveillance and security guards.



Figure 6.202 – Terminal levels: terrain and parking lot level

The terminal is directly connected to the Vasco da Gama shopping mall, so passengers can shopping while wait for their transport. This mall is also connected to an important city green space near the river where several cultural equipments are installed, for example, Lisbon Oceanarium, a Science Museum and the Casino.

Another relevant station in the north rail-line is Vila Franca de Xira (Figure 6.203). In this station circulates inter-urban, inter-cities and regional trains. Vila Franca de Xira station is 20 km away from Gare do Oriente.



Figure 6.203 –Vila Franca de Xira rail station

The cities surrounding the Vila de Franca de Xira are presented in Figure 6.204, where there is a significant population concentration within a 10 km radius from the station (92,656 inhabitants). The main cities in the vicinity of the station are Vila Franca de Xira, Alverca do Ribatejo, Alhandra and Vialonga. This population concentration might justify the creation of dedicated feeder services from these locations to the Vila Franca de Xira station.

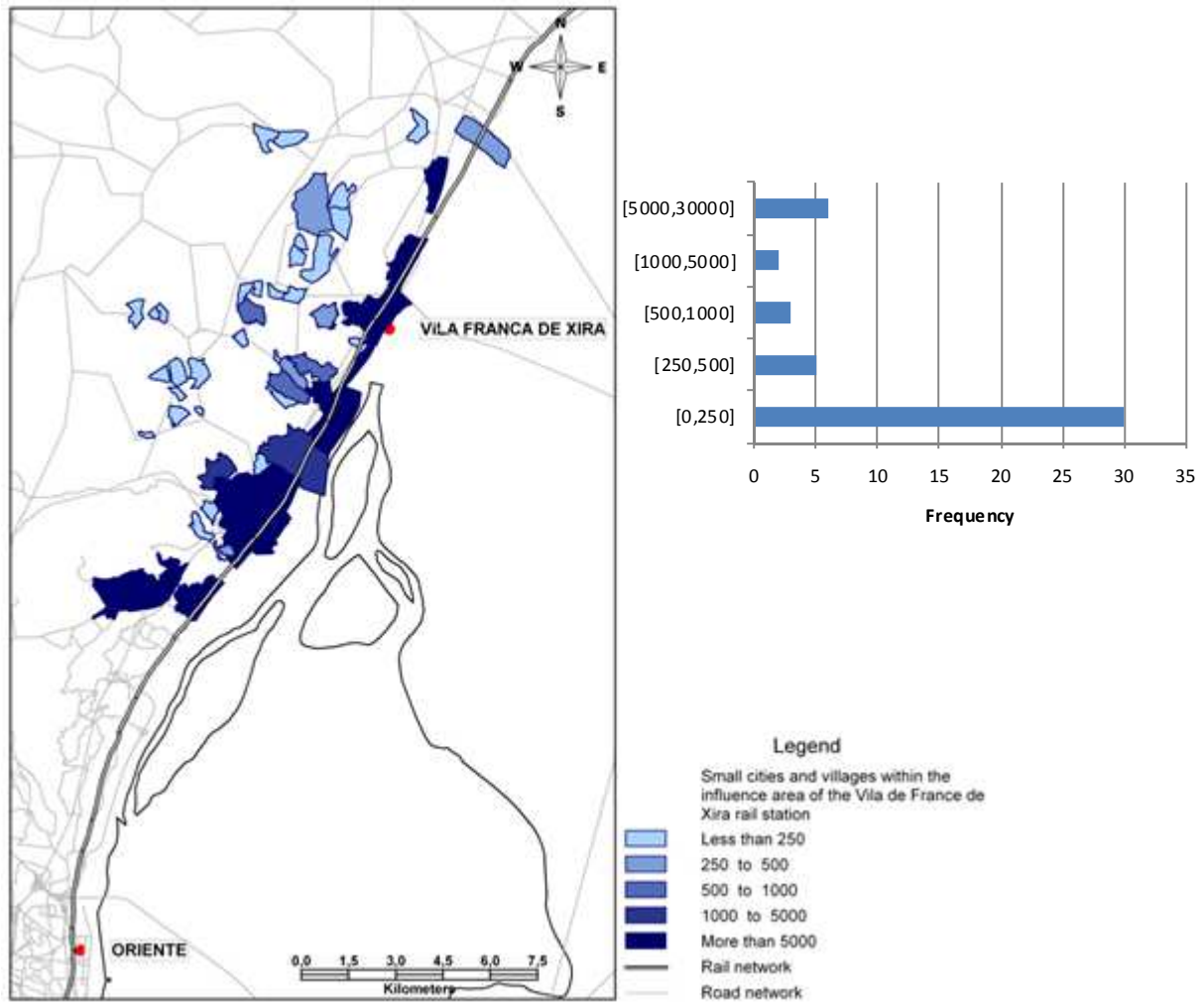


Figure 6.204 - Vila Franca de Xira rail station

6.4.1.1 Identification of the site

Transport mode connections at Gare do Oriente Intermodal Terminal will now be characterized in terms of the services provided. The Lisbon subway network as four different lines, each one of them crossing all the others in at least one station. Figure 6.205 shows the network diagram with the Oriente station marked with a black circle. Subway operates every day from 6 a.m. until 1 a.m..



Figure 6.205 – Lisbon subway network diagram

The rail station at Oriente is located on the top of the terminal with six different boarding platforms that can be accessed by escalators or lifts. The most important passenger train connections of long distance (national and international) have a stop in Oriente: Oporto, Faro, Aveiro, and Coimbra among others. There are also direct interurban train connections here with Sintra and Azambuja lines. The most important rail connection within the national rail network is Lisbon - Oporto, with high flow of daily trains.

Bus connections provided in Gare do Oriente are diversified. CARRIS operates urban buses to several places in Lisbon and a direct link to the airport, 4 km away from this terminal. There are also other companies providing longer distance bus services, for example, RENEX has buses to Algarve and the to the north of Portugal and TST has suburban buses to the south bank of Tagus River. The underground parking lot has a capacity of 2000 vehicles. And there are also other parking lots near this one, for example at the mall, with more than 1000 parking spaces.

Vila Franca de Xira will be addressed as a potential intermodal/distribution node since it has a privileged location and is closer to Lisbon, which allows a proper and rigorous field analysis.

Vila Franca de Xira is a traditional station with double track and is located 20 km from Gare do Oriente (Lisbon). This intermediate location allows a short and faster connection to other medium-sized cities, located closer to Vila Franca de Xira than to Gare do Oriente. Currently, there are taxi services and short-distance bus trips to small villages provide by BoaViagem connecting this station and small-sized cities closer to it, but the schedules of those bus services are linked much more to the suburban rail services than to the long distance rail services.

6.4.2 Method for data collection

6.4.2.1 Introduction

In order to assess the market potential of new bus transport services to and from train stations along the Lisbon North railway corridor before arriving to the final station at Oriente at stations like Vila Franca de Xira, a survey to clients of intercity trains was administered at the Oriente Station. The main goal of the survey was the identification of the origin location (residential or not) of the clients to these services along the day, thus allowing subsequent estimation of the potential for those new bus services from other stations.

The survey was conducted during two different week days (Wednesday and Friday) to clients of seven intercity services with origin at the Oriente station (from 7:39 am to 9:39 pm).

The obtained sample resulted in a total of 1,653 responses (511 in Wednesday and 1,142 in Friday), surveying an average of 76% of the customers, which is a significant sampling rate to evaluate the spatial pattern and mobility profile of the customers of this service. The results obtained show a significant difference in number of passengers between a regular Wednesday and a Friday (90% of passengers increase), evidencing a significant share of travellers that might use this service to exit the city or return to their home town during the weekend. Nonetheless, the total number of clients taking this service at the Oriente station for seven rail services during a whole day is not very high, obtaining values around 500 passengers during a regular, doubling during Fridays.

The distribution of activities before the rail trip during the day is presented in Table 6.1. The results show an even distribution of trips during the day; yet, the types of activities are mainly from home and work or study.

Table 6.1 – Distribution of types of activities before travel per period of the day

Activity before travel	Afternoon	Between peak hours	Morning	Night	Total
Home	97	196	185	106	584
Leisure or shopping	42	96	47	48	233
Other	18	31	6	4	59
Work or study	205	233	56	283	777
Total	362	556	294	441	1,653

The spatial distribution of the surveys is presented in Figure 6.206, where a greater concentration of origins within Lisbon can be observed, followed by a considerable number of passengers from the Sintra and Cascais corridors in the North part of the Lisbon Metropolitan Area (LMA).

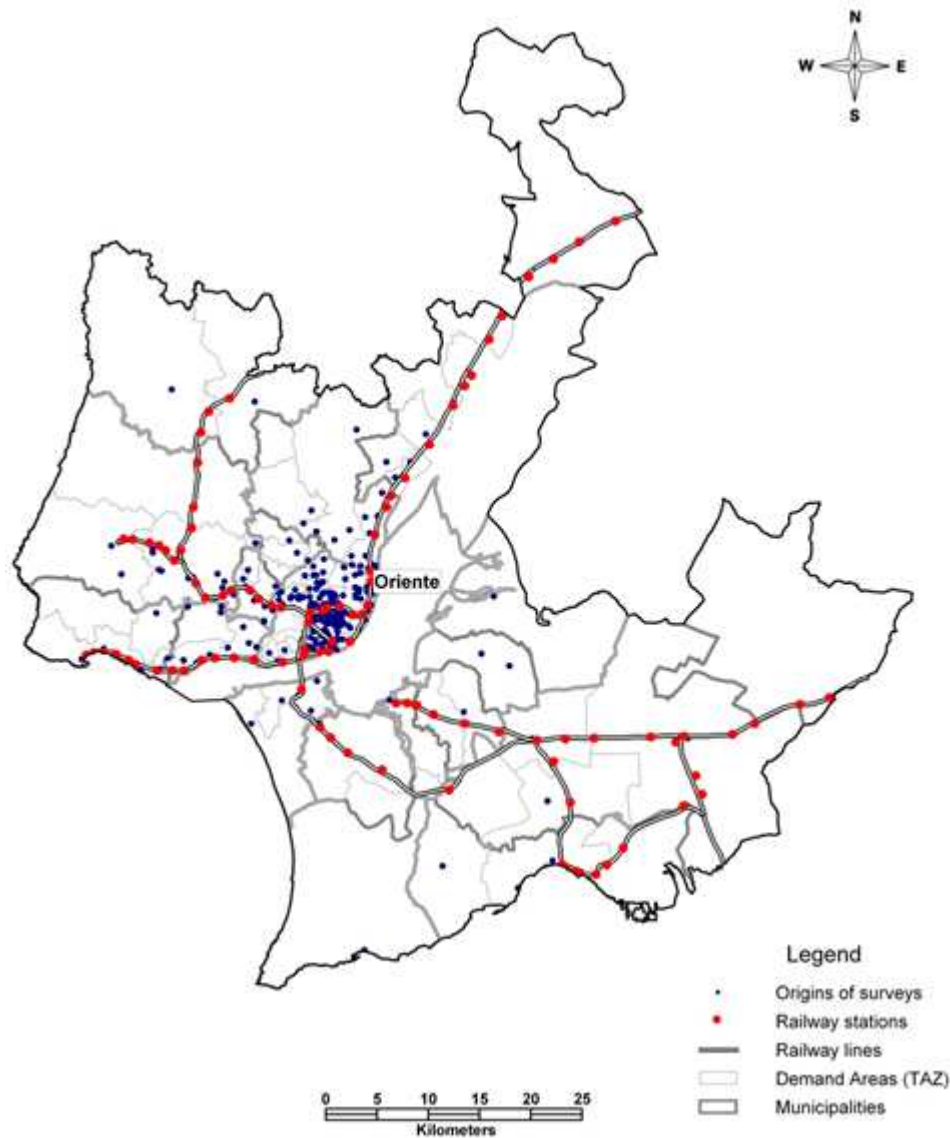


Figure 6.206 - Spatial distribution of the surveys

The aggregation of the surveys into different demand areas in the LMA (66 zones) shows a pattern similar to that identified in the previous map (Figure 6.207). However, in this figure a greater relevance of the North corridor along the Tagus River is perceived than in the previous analysis. This fact is derived from demand with origins close to Lisbon and the Oriente station but already inside the neighbour municipality of Loures. This spatial distribution is visible in

greater detail in Figure 6.208 where we can see than the demand observed at the Oriente station for intercity rail services is mainly located within a 5 km radius from this station.

Using this estimated spatial pattern of the demand of rail intercity services in the Lisbon's North railway corridor, we can conclude that there is no sufficient demand located close to other intermediate rail stations of this service to justify the development of new bus services. The total number of customers on the sample located closer to Vila Franca de Xira than from the Oriente station was 28 for the whole day, that using the survey sample rate would lead to 37 passengers distributed along the day. This low estimated demand does not justify the creation of an alternative bus feeder service at the Vila Franca station, resulting in an average of 5 clients per train. This level of demand estimated would be only sufficient for taxi services, which already exist on the Vila Franca de Xira station.

The analysis of the measured demand patterns shows that the market to feed this railway service is already balanced between demand and supply, and passengers are already well served in terms of public transport accessibility by the large amount of urban and suburban services available at the Oriente station (rail, subway and bus).

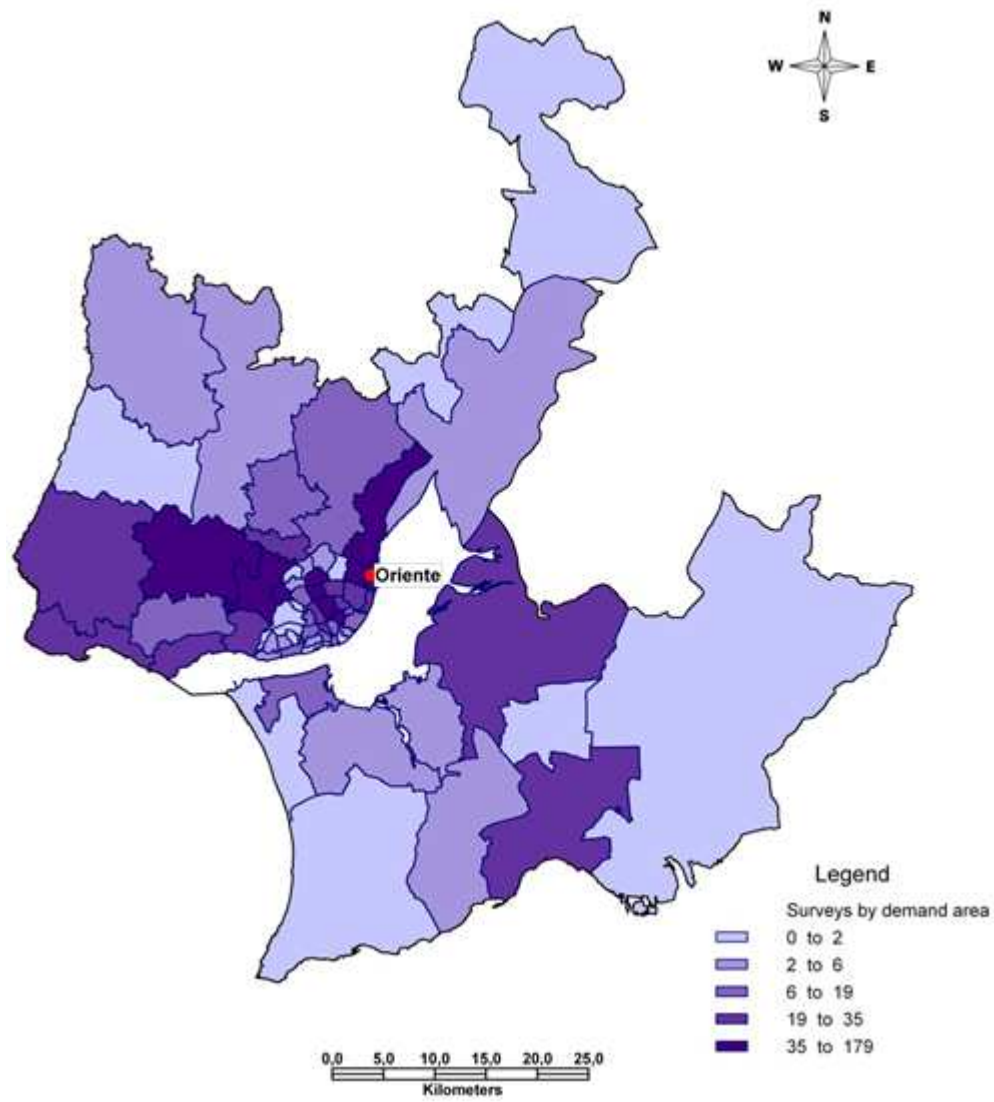


Figure 6.207 - Aggregation of the surveys into different demand areas in the LMA

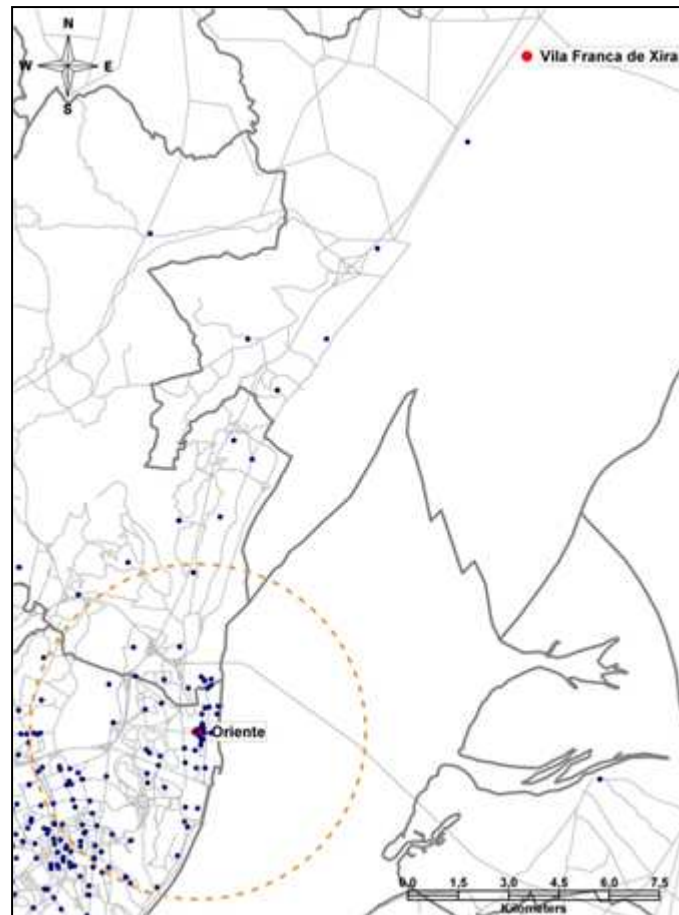


Figure 6.208 – Detailed analysis of the demand around Oriente and Vila Franca de Xira station

6.4.3 Stakeholders/Agents at the site

Linha do Norte stakeholders are:

- CP – responsible for the railway operations;
- REFER – responsible for the railway infrastructure management.

CP and REFER are public companies, owned by Portuguese Government. CP is the owner and operator of trains. REFER is the responsible for infrastructure management and maintenance. Train schedules are produced by CP and validated by Refer.

Responsibility for the management of Gare do Oriente terminal lies with a company called GIL (Gare Intermodal de Lisboa). GIL is a public company responsible for the management, coordination and cooperation of all terminal related concerns.

Other stakeholders at Gare do Oriente are:

- **Public Decision Makers:** Municipality of Lisbon - owner of the land and car-parking;

- **Transport Operators:** short and long distance bus companies - CARRIS, RENEX, TST, Rodoviária de Lisboa), subway operator (ML), trains operator (CP), railway infrastructure management (REFER) and taxis;
- **Users association:** DECO.

Vila Franca de Xira train station stakeholders are:

- **Public Decision Makers:** REFER (owner of the railway stations) and the municipality of Vila Franca de Xira;
- **Transport Operators:** short distance bus operator (BoaViagem) and taxis;
- **Consumers' Association:** DECO.

DECO, the national consumers' association, does not usually interact with GIL or transport operators but if any passengers complain the association may intervene and contact GIL in order to defend passengers' rights whenever it is necessary.

The relevant agents for the definition of the business models are:

- Passengers;
- CP;
- Taxis;
- Bus operator;

6.4.3.1 Objectives and Goals

The objectives and goals of each agent are as follows:

- **Passengers:** minimize travel time and cost;
- **Transport operators:** maximize customers number and revenues;
 - CP
 - Taxis
 - Short -distance bus operator (BoaViagem)

6.4.3.2 Strategies

The strategies of each agent to attain the abovementioned objectives are now presented:

- **Passengers:** although we may classify the passengers in different clusters according to diverse attributes (such as: purpose of the travel, with whom are they travelling, who has booked the trip, how often do they travel, etc), ultimately all of them share a common goal: to reach the final destination safely, with reasonably low travel time and transport costs. What changes among them is the willingness to pay for getting different services, and how do they perceive the quality of the service;

- **Transport operators:** (taxi and public transport companies) ultimately, these agents seek to increase the profits. In this case study, and for simplification purposes, we assume that this may be achieved through an increase in the throughput of passengers (since prices are strongly regulated by the National Government).

6.4.3.3 Interactions between agents

The following matrix presents the interactions between each pair of agents. The interactions have been classified as follows:

- Service Provider: when there is a client – provider relationship between the pair of agents;
- Competition: when the two agents compete against each other.
- Cooperation: when the pair of agents cooperate to improve the quality of the service to the passengers.

Table 6.2 - Interactions between agents

<i>Agents</i>	<i>Passengers</i>	<i>Trains</i>	<i>Taxi</i>	<i>Buses</i>
<i>Passengers</i>		<i>Service Provider</i>	<i>Service Provider</i>	<i>Service Provider</i>
<i>Trains</i>			<i>Cooperation</i>	<i>Cooperation</i>
<i>Taxi</i>				<i>Competition</i>
<i>Buses</i>				

6.4.3.4 Graphical representation

Based on the concept of agents and on the web of interactions between the various agents, the following figure represents the current business model according to Agent Based Model representation (Figure 6.209).

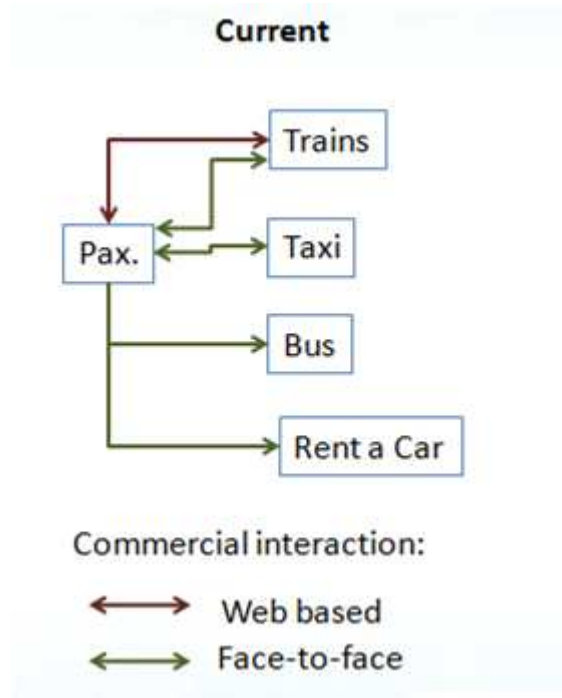


Figure 6.209 - Agent Based Model Graphical representation of current Business Model

6.4.4 Current short-long interconnectivity problems/opportunities

Gare do Oriente Interchange Station has very good and diverse transport connections as it was mentioned above. Nevertheless, connections to these small cities are only provided by bus from this station although there are rail stations in north rail-line that are geographically closer from these cities.

Our expectation is that there could be an interesting number of passengers whose final destination is a city geographically near from a rail station in the north rail-line that have to departure from Lisbon since there are no transport connections from the other rail stations. This is the case of Vila Franca de Xira rail station, which is closer to some of those small-cities than the oriente station in Lisbon, but does not offer adequate bus transport connections.

Our intention is to provide better transport service to rail passengers without affecting the quality of the rail services.

The main problems identified along the north rail line are:

- Poor connections to small-sized cities from train stations in the greater Lisbon area (most connections are only provided from Gare do Oriente);
- Poor or inexistent information about further connections (besides train) or adjustments of connections;
- Poor information signaling in the stations;

We had also identified the opportunities at the site:

- Good road connections from other train stations besides Gare do Oriente to small-sized cities;
- Space for information desks at train stations or information displays;
- Good access for people with special mobility needs.

6.4.5 Current value proposition

Current value proposition is characterized by good railway service in the Linha do Norte rail link, with good integration to bus services from Lisbon Oriente to small-cities . Passengers with destinations in the greater Lisbon area always have to use Lisbon as an origin point despite other rail stations being geographically closer to serve these small-cities. Vila Franca de Xira, for instance is closer to Coruche than Lisbon but there are no bus connections nowadays from there. Other example is Santarém which is closer to Peniche than Lisbon but once again there are no bus connections to Peniche except from Lisbon.

Vila Franca de Xira is the city that we choose to analyse for the reasons described on chapter 2.1. Vila Franca de Xira is the rail station that we choose to address in this study. Decision was based on the fact that this station is the closest to Gare do Oriente where we first notice that passengers have to go backwards (to Lisbon) to reach small-cities near from Vila Franca de Xira that currently are not served by any transport connection from there.

6.4.6 Description of current business model

According to Osterwalder (2004) there are nine building blocks Customer Segments (CS), Value Propositions (VP), Channels (CH), Customer Relationships (CR), Revenue Streams (R\$), Key Resources (KR), Key Activities (KA), Key Partnerships (KP) and Cost Structure (C\$).

6.4.6.1 Customer Segments (CS)

The Railway operator (CP) does not have data regarding customer segments or origin/final destinations information. It only has information concerning entrances and exits on rail stations.

In 2010, more than 470,000 passengers arrived in Gare do Oriente in inter-city trains and more than 28,000 arrived in Vila Franca de Xira in this class of trains. Suburban and regional trains are not accounted for in these numbers.

Suburban trains carry in the pick-hour period more than 500 passengers per train between Vila Franca de Xira and Gare do Oriente. As these two cities are close and have frequent services between them, we have a huge number of daily home-to-work and home-to-school trips.

6.4.6.2 Value Proposition (VP)

From Gare do Oriente Intermodal Terminal passengers can use direct or indirect connections to urban, national or international destinations. Terminal offers long and short distance trains, subway to city centre, short and long distance bus connections, taxi services and rent-a-car is also an option. Lisbon Airport is 4 km away from the terminal and a few buses provide fast connections between these two sites.

Bus, subway and suburban trains can be accessed with the same card – Viva Viagem – valid for the Greater Lisbon area, which passengers can charge. Long distance trains require a particular ticket as well as long distance buses.

Long distance trains present two different travel classes that passengers can choose according to their preferences. Buses do not present different travel classes. Short distance buses can be accessed by people with reduced mobility as well as the subway. In general, trains are not design to receive people with reduced mobility; most of them are quite old. Nevertheless, the new ones are appropriate.

Trains and bus present very high levels of reliability and punctuality (punctuality is around 97%). Bus reliability are also high but punctuality is lower than the other two modes since buses do not have a continuous dedicated traffic lane as trains have.

Passengers usually prefer subway over bus due to longer travel times in the latter. Nevertheless, buses are a common option due to their travel routes and destinations that subway does not serve.

Vila Franca de Xira station does not have all these connections. In Vila Franca de Xira station passengers can find taxis and a few bus connections to small towns nearby.

6.4.6.3 Channels (CH)

A website integrating information about the services of all local and regional public transport operators in the Greater Lisbon area is available to the public. Passengers can plan their trip based on the available information on that site. CP and Carris, for example, provide timetables, prices and also the possibility to find the best route for any O/D pair in the region.

Gare do Oriente Intermodal Terminal has several displays with information about trains timetables and departure platforms. This is the transport mode with more information at the terminal. The other transport modes only have signpost indicating where passengers can find them (taxis, subway and buses). Here taxis are available at the terminal 24 hours a day. Subway operates between 6 a.m. and 1 a.m. Carris (urban buses) provides displays at bus stops with information on waiting time for the next bus.

Urban bus ticket sales are made at appropriate spots, usually on bus terminals. Long distance bus tickets are sold on appropriate spots inside the corresponding bus terminal. Subway tickets are sold on subway entrance through automatic machines or a counter with an agent. Long distance train tickets are sold in the train terminal by an employee or through the operator's website. Short distance train tickets are sold through automatic machines at the stations.

Transport operators advertising is present in the platforms used by the operators and also inside their transport vehicles. Each transport operator only has ads for his own services.

6.4.6.4 Customer Relationships (CR)

Train stations are a privileged site for the relations between passengers and transport operators, since stations work as an intermodal node. Gare do Oriente Intermodal Terminal presents good signalling that passengers easily understand and follow. Customers can wait for the trains at the platform, which can be windy and uncomfortable in cold days, or use dedicated waiting areas at a level below the platform. The bus waiting areas are located in the street with no protection from wind or cold.

In Vila Franca de Xira, train station information is scarce and dispersed. Passengers have to deduce that buses and taxis are available outside the station. Bus waiting areas at this stations are also exposed to wind or cold.

Transport operators present either of these railway stations (Gare do Oriente and Vila Franca de Xira) do not have specific loyalty programs for their passengers. Nevertheless, short distance travel by train, bus or subway can be supported with a monthly card that is much cheaper than buying single tickets for every trip (some 40% discount in average).

The subway and trains have at Gare do Oriente information desks, which can be used also to buy tickets. Yet, most of the passengers use the self-service ticket machines. Bus information desks are scarce at both stations. These information desks are also the place where passengers can buy a bus ticket (as well as on-board, at a higher price).

6.4.6.5 Revenue Streams (R\$)

The main revenue sources of the railway operator are ticket sales. Besides passengers, cargo transport also represents a (much smaller) source of revenues for this company. Subsidies from the National Government are also a regular and important source of revenue, mostly connected to the provision of Public Service Obligations.

The urban bus operator at Gare do Oriente, Carris, is also a public company. Its main revenue source is ticket sales and indemnities for Public Service Obligations. Advertising at vehicles is also an interesting revenue source. The revenue streams for the Subway operator, Metropolitano de Lisboa, are the same as described for Carris.

The bus company present at Vila Franca de Xira is BoaViagem. This is a private company, as opposed to other public transport operators mentioned above, relies integrally on tickets sells and private transport services provided. The company receives a small public subsidy associated with its participation in the monthly card scheme at very discounted prices.

Long distance buses, available at Gare do Oriente, are provided by private companies with no subsidy at all. Their main revenue sources are ticket sales and chartering buses for non regular services.

6.4.6.6 Key Resources (KR)

Each stakeholder has its own set of key resources depending on its business and positioning in the transport chain. In general terms the resources can be divided into the following types:

- Vehicles
- Infrastructure
 - Physical infrastructure (includes: airport terminal, parking lots, parking stands, front desks, etc)
 - Technological infrastructure (includes: websites, communication systems, etc)
- Human Resources

6.4.6.7 Key Activities (KA)

The key activities are related with the provision of transport services. Like the previous building block, the activities are function of the stakeholder's positioning in the transport chain. In general terms these can be divided in the following ones:

- Customer oriented activities:
 - Information and Marketing - activities related with the promotion and advertisement of the transport services, communication with the passengers and selling of tickets;
 - Transferring - activities, services and amenities aiming to provide a comfortable experience to the passengers while changing modes at the Oriente station (including: resting areas, small shops, food courts, etc).
 - Transport service - activities related with the transport of the passengers;
 - Parking - temporary storage for private vehicles, particularly travellers in the long distance railway services;
- Stakeholder (or internal) oriented activities:
 - Financing and Economics - activities related with the assessment of costs, revenues, financing and similar activities.
 - Planning and Management of Operations - activities related with the planning of the transport services (in terms of scheduling, paths, costs, etc) and related with the daily execution of operations.

6.4.6.8 Key Partnerships (KP)

Railway operator (CP) has partnerships with rent-a-car companies that give to clients discounts in car renting. This operator also has partnerships with the company managing the Gare do Oriente, under which discounts on the parking prices are provide to those clients who can exhibit a railway ticket corresponding to the period of stay of the car at the park.

In Vila Franca de Xira station no partnerships were registered although the rail operator is the same.

6.4.6.9 Cost Structure (C\$)

The cost structure is specific of each stakeholder. Yet, the main items of the cost structure include:

- Human resources;
- Vehicle and fleet (acquisition, rental and maintenance);
- Infrastructure (planning, building and maintenance);
- Fuel;
- Debt, amortization and other. What kind of economies does the company have (e.g.: scale, density and scope)?

6.4.7 Analysis for improvement of interconnectivity

6.4.7.1 Missing links and new Value Proposition

It was already pointed out that despite the quality of the railway service, and the several connections from Lisbon to small-cities provided by bus, passengers always have to come to Lisbon to reach these small-cities despite the existence of rail stations that are geographically closer. Vila Franca de Xira, for instance does not have any bus connection to Coruche which is a small-city 60 km away. Passengers have to come to Lisbon and here take a bus despite Lisbon is 85 km away from these city.

As there is a considerable population concentration around Vila Franca de Xira, the passengers from the nearby locations could take the train at this station instead of going to Oriente, if they could have a quick and efficient bus connection to the Vila Franca de Xira station. This means that passengers have to move backwards since if they are for instance in Vila Franca de Xira, they have to come south to Lisbon and then northwards from there to the final destination.

It could be interesting to provide quick transport connections to small-cities relatively near the Linha do Norte that nowadays are only served by bus connections starting at the Oriente station in Lisbon. Our intention is, as it was mentioned above, to assess the feasibility of creating a proximity transport service to population that live in these areas, taking advantage of rail stations that already exist since this service has good quality levels. This study aims to evaluate, as mentioned above, the potential demand for the creation of a proximity transport service to population that live in these areas.

6.4.8 Actions for improvement of interconnectivity

6.4.8.1 Proposal

The analysis of the survey results clearly shows that our initial hypothesis was not confirmed, thus leading to the conclusion that it does not make sense to develop new direct bus services from Vila Franca de Xira rail station to small-cities nearby. With such a small market potential the new transport service is not feasible.

The analysis of the measured demand patterns shows that the market to feed railway service is already balanced, and passengers are already well served in terms of public transport accessibility by the large amount of urban and suburban services available at the Gare do Oriente station.

6.4.8.2 Description of new business model

Since the initial hypothesis was not confirmed, no new services are needed and no change in the prevailing business models is necessary. As it was mentioned above, transport market regulated and balanced, so, passengers that need to travel to the small-city are using other transport (i.e. private car) and not train plus other mode.

In theory, because surveys were only done at the railway station, it is possible that there are several potential customers for those bus services feeding the intermediate railway stations that currently use another transport mode for their long distance trip, for example, private car. We believe this is not the case, because in any case the travel time by car or bus from those small cities to the Oriente station is rather short (always below 30 minutes) and so the advantages of using the rail for the long distance trip are already within reach.

6.4.8.3 Added value from the case study to the HERMES project

Although this case study did not allow developing a new feasible proposal and consequently a new business model, it is important to point out a few aspects.

First of all, this case study feeds the prototype presented in Work Package 2 that related with issues on the links. Despite the conclusion that there is not enough customers to create a new transport service it is certain that transport provision are not the ideal but the possible. So it is undeniable that there is a low quality service for a few locations although the general provision is good.

Secondly, this case study allows understanding that our hypothesis was not correct at least based on the survey results for train users. However, this let us understand that

interconnectivity at the terminal can be very good, but 20 km away from this terminal the situation is the opposite.

6.5 Intermodal Network of Lyon Metropolitan Area, Part Dieu Station, France

The REAL project (REAL is a French acronym for Express Network for the Lyon Metropolitan Area) aims to develop intermodality at the Lyon metropolitan Area. To achieve this goal, involved partners reinforce public transport networks integration and coordination. The plan of actions is composed by five items:

- Transport service coordination ;
- Rail station development and associated services for passengers : modernization and creation of exchange nodes, development of fall-back parking areas;
- Accessibility to stations : adaptation to disabled persons, organization of modal shifts;
- Multi-modal services : information system for users, pricing and ticketing services;

These common items concern also several projects participating in the development of intermodality in the Lyon Metropolitan Area like the Rhone-Express tram-line between Part-Dieu and Lyon St. Exupéry airport in 2010, the T3 tram-line (between Part-Dieu and Meyzieu) in 2006 and the new Jean Macé railway station in 2009.

Many institutional actors are involved in this project: Regional Council (Rhône-Alpes Region), General Councils (Département du Rhône and Département de l'Isère), Grand Lyon (Lyon and 55 others communities), Villefranche urban communitie, Nord-Isère communitie, SYTRAL (Syndicat des transports en commun de l'agglomération lyonnaise), SNCF (Société nationale des chemins de fer français), RFF (Réseau ferré de France).

The REAL project is a huge and very ambitious project not only focusing on a station or a transport mode but referring to interconnection between every public transport modes at short (local or regional by urban public transports or regional trains and bus) and long distance (national or international by train or plane). To bring out some lessons for intermodality coordination and integration, the contribution to the project will focus on the specific case of the Part-Dieu intermodal station.

6.5.1 Main features of the site

The Part-Dieu intermodal station was put into service in 1983 as a part of a new urban planning policy aiming at building a second urban city centre in Lyon (see Figure 6.210). The station implementation is concomitant to the development of an administrative, financial and commercial centre in its neighbourhood. The Part-Dieu station is today one of the most important station in Europe for transit passenger traffic. It is served by rail lines like national and international high-speed lines (TGV), national rail lines (Intercités and Lunéa), regional lines

but also by urban public transport lines and since august 2010 by a new tram-line to link with the St. Exupéry Airport.



Figure 6.210 : Overview of the Part-Dieu station
(photo : Aurélie Mercier)

6.5.1.1 Identification of the site

6.5.1.1.1 Geographical coverage

The Part-Dieu station is composed by a concourse of 8348 m² (around 65 meters over 120 meters) under a concrete viaduct supporting tracks (see Figure 6.211 and Figure 6.212). The Part-Dieu station is opened from 05:00 AM to 00:45 AM. It proposes and connects different transport modes (rail, bus, car and two-wheel modes) at long and short distances (see Figure 6.213).



Figure 6.211 : Part-Dieu station concourse
(photo : Aurélie Mercier)



Figure 6.212 : Stairs to access to the tracks
(photo : Aurélie Mercier)

The **rail mode** is composed by four main passenger lines :

- Long distance high speed lines (TGV) serving national and international cities among them Paris, Marseille, Genève, Bruxelles;

- Long distance national lines (Intercités and Lunéa lines) serving cities outside the Rhône-Alpes region;
- Short lines serving cities inside the region Rhône-Alpes or at its periphery with regional rail lines (TER lines) and serving areas inside the Grand Lyon (tram lines).
- The third main rail transport mode is **RhôneExpress tram-train line** (light rail transit) linking the Part-Dieu and the St. Exupéry Airport is not exactly an urban mode but cannot be considered as a Regional rail-line.

The second group of transport modes refers to **bus mode**. The Part-Dieu station is served by 15 different urban/interurban bus.

The third transport mode is car with taxi, private and rental car possibilities for shorts and long distance interconnections.

The Part-Dieu station is therefore a multi intermodal station. Different inter-connections are possible:

- high-speed rail lines or national rail lines (long distances rail lines)- regional/urban rail or bus lines (short distances), and the opposite
- high-speed rail lines or national rail lines (long distances rail lines) – cars (short distances), and the opposite
- regional/urban rail or bus lines (short distances) – regional/urban rail or bus lines (short distances)
- regional/urban rail or bus lines (short distances)- cars (short distances), and the opposite

Long distance high-speed (TGV), and other networks (Intercités, Lunéa and TéoZ) are represented in Figure 6.214, Figure 6.215, and Figure 6.216. Lyon urban network is illustrated Figure 6.217.

Beyond transport services, the Part-Dieu station offers associated services like a “Salon Grand Voyageurs”, restaurants or take-away food shops (11 restaurants), one bank, one perfume shop, one record and bookseller, two shops for clothes and two press retailers.

Transport modes / services	Rail services	Bus services	Car services
Geographical coverage			
Long distance services >100 km	1) International rail service 2) Interurban rail service		1) Taxi 2) Privat car 3) Rental car
Short distance services <100 km	1) Metro service 2) Tram service 3) Commuter train service 4) Interurban rail service	1) Interurban bus service 2) Urban bus service 3) Shuttle service	1) Taxi 2) Privat car 3) Rental car

Figure 6.213: Long-distance services per mode and short-distance services per mode



Figure 6.214 : French long-distance high-speed network (Guide TGV. Information voyageurs SNCF, Juillet 2010)



Figure 6.215 : Intercités network (Guide Intercités. Information voyageurs SNCF, Juillet 2011)

Figure 6.216: Lunéa and Téoz networks (Guide Lunéa. Information voyageurs SNCF, Juillet 2011)



Figure 6.217 : Lyon urban network

(http://www.tcl.fr/index.asp?page=plan_reseau)

6.5.1.1.2 Transport modes and services per transport mode

6.5.1.1.3 The rail mode

For a weekday in December 2009, the Part-Dieu station has been served by 577 trains (tram and subway lines are excluded from these data) : 377 departures, 375 arrivals and 70 trains without stops. Among them, 55% are short distance lines (Regional lines), 26% are long distance lines, 18% are fret or other lines (see Marie-Line MEAUX, 2009). The station is also served by 2*12 underground trains per hour and 2*16 tramways (2*8 for the T1 line and 2*8 for the T3 line). The RhôneExpress shuttle operates from 05:00 AM to 12:00 PM with a tram-line every fifteen minutes from 06:00 AM to 09:00 PM and every thirty minutes from 05:00 AM to 06:00 AM and to 09:00 PM to 12:00 PM.



Figure 6.218 : Daily rail traffic from Part-Dieu station to other regional metropolises located outside the Lyon urban area (origin : Egis and RFF – July 2010)

6.5.1.1.4 The bus mode

This mode represents 13 bus urban lines, two of them are trolley bus lines. Standard urban bus has a capacity around of 50 passengers and trolley bus can contains 110 passengers with 34 seats. The bus frequency is estimated between 6 (for the trolley bus lines) to 15 minutes (for other lines) according to the lines and the hour of the day. Note that the bus network will completely be changed at the end of August 2011 with a new bus lines hierarchy and a network simplification. Two interurban bus lines complement the urban bus network. Each of these two interurban short lines has a frequency of 1 bus per hour.

6.5.1.1.5 The car mode

Private car is the most commonly private motorised mode used from or to the Part-Dieu station. Five car parks are currently listed around de station (a drop-off car park where the first 20 minutes is free and four charged parks). Total of car parks near the Part-Dieu station proposes more than 5,500 parking places with a decreasing rate of charge closed to 1,9€ per hour. Each car park offers parking places for disabled travellers but their number has not been spread out. To complete the car associated services, four taxi companies (with a total of 96 places) and six car rental shops are located in the station.

6.5.1.1.6 The two-wheels modes

A free two-wheel modes parks, with 20 places, is offered to the station users. The Part-Dieu station is also served by the bike service called Velo'v with three stations close to the rail station.

According to the terminal manger data, 35% of the rail station users come by car; 6% by taxi; 1% in two-wheel modes; 48% by public transport and 7% walking (see Gares & Connexions, 2011).

6.5.2 Methods for data collection

6.5.2.1 Observations and collected material

6.5.2.1.1 Transport demand/Passenger flow

Three different types of passenger flows are needed to study the Part-Dieu station item: regional rail lines passengers, other rail lines passengers (high speed lines, national lines) and urban lines passengers. Note that an intermodal passenger using the Part-Dieu station can be both a rail (short and long distance) and an urban system user or a short distance and long distance rail line user. Traffic estimations are collected from the appropriate stakeholder:

- Rail transport demand estimations are available on the Regional Council (for regional rail demand) and on the SNCF (for regional, national and high-speed lines).
- Urban public transport demand data is hold by the Organizing Authority (i-e the Sytral) and the operator Keolis Lyon.

These passenger flow data are tally with Lionnel Grand's informations (Lionnel Grand is the Part-Dieu station project director).

6.5.2.1.2 Time data

Service times are available to the public whatever the transport mode (regional or other rail lines, urban public transports). These service times are often available on web-sites (www.sncf.com; http://www.ter-sncf.com/Regions/Rhone_Alpes/fr/Default.aspx; www.tcl.fr). Waiting time on the Part-Dieu station can be estimated comparing different modes timetables or analysing customer survey.

Note that we have to include a walking time in trans-boarding time to cross totally or partially the station. This trans-boarding time depends on period of the day and on the level of congestion on the station. Trans-boarding time will be evaluated both from in-field observations and from surveys. These surveys don't aim to evaluate exact trans-boarding time but trans-boarding time as perceived by Part-Dieu users (cf. item n°13 : "Approximately, how long will you be staying at the station?").

6.5.2.1.3 Space data

Physical configuration of passenger facilities is a key issue on the Part-Dieu station analysis. A new configuration of both travelling stores and departures-arrivals boards has been tested in

2010 to increase passenger walking lanes. A two-level investigation has been operated as follows:

- Part-Dieu terminal manager interviews to highlight space congestion problems and to consider solutions to remedy saturation.
- Part-Dieu users' interviews will allow comparing user and manager points of views of spacing issue perception (cf. Item n°16 : "How easy or hard do you think it was to find your way?"; item n°17: "How satisfied or dissatisfied are you with the space at the station?")

6.5.2.1.4 Information, Ticketing and Check-in Services data

The Part-Dieu station includes different types of information and ticketing services. In spite of an intermodal tariff for regional rail passengers using urban public transports, each transport mode (rail or urban public transports) has its own information and ticketing service. Thus, different investigations have been conducted according to the specificities of transport modes. For the rail mode, the investigation refers to the Part-Dieu terminal manager interview. The interview mainly focuses on transmission of information to the rail users (arrivals and departures board, soundtracks...) and the problems it generate (for example, in the Part-Dieu station one the two biggest arrivals and departures boards has been replaced by smaller ones to limit mobs of people behind the two boards). The customer survey is also investigated to analyse users' opinion on information and ticketing services (cf. Part 2d : Information and ticketing services).

For urban public transport modes, only users will be questioned on their information and ticketing service perception and satisfaction (cf. Part 2d : Information and ticketing services).

6.5.2.2 *Customer survey*

6.5.2.2.1 Sample size

See Table "Lyon Case Study customer survey"

6.5.2.2.2 Distribution of the questionnaires

See Table "Lyon Case Study customer survey"

6.5.2.3 *Stakeholder interviews*

Two stakeholders interviews (Lionnel Grand : Part-Dieu station project director and Sylvie Hamelin-Thibaud from the Rhône-Alpes Region – the Organizing Authority for regional rail transport) have been performed in formed of "one to one debate" based on questionnaires proposed by the WP2/WP3. These interviews have been conducted between the end of 2010 and the first quarter of 2011. They have been supplemented by non-formal interviews with

Rhône-Alpes Region or SYTRAL (the Organizing Authority for urban public transport of Lyon that represent the Urban Community of Lyon and the Rhône department) representatives.

PART-DIEU STATION CUSTOMER SURVEY				
	TOTAL	Rail lines users (excepted regional rail lines)	Regional rail lines users	Urban public transports lines users (Bus, tram, metro)
ONLY INTERMODAL USERS ARE QUESTIONNED				
Period of survey	Between the 18th of april to the 13th of may 2011 : from monday to friday			
Number of answers	746	235	266	245
Place of survey		On and nearness the Part-Dieu station enclosure	On and nearness the Part-Dieu station enclosure	On and nearness the Part-Dieu station enclosure
Period of the day		80 in peak hour + 20 in off	80 in peak hour + 20 in off peak	80 in peak hour + 20 in off peak
<i>Morning peak hour : 06:30 - 10:00</i>		0	20 (7%)	14 (6%)
<i>Off-peak hour : 10:00 - 17:00</i>		119 (51%)	111 (42%)	86 (35%)
<i>Evening peak hour : 17:00 - 21:00</i>		116 (49%)	135 (51%)	145 (59%)
Number of pollsters		5	8	5

Figure 6.219 : Lyon Case Study customer survey

6.5.3 Stakeholders at the site

A large number of stakeholders are identified on the Part-Dieu station. The first one is the terminal manager with “Gares et Connexions”, a recent SNCF business unit in charge of French rail stations. As explained by Sophie Boissard, Executive Manager of Gares & Connexions (see : <http://www.gares-connexions.com>), “Gares et Connexions” is in charge of managing the stations. It is also responsible for station development and investment plans, in collaboration with stakeholders. It has two key commitments - making progress in the fundamentals of station service, and modernising and adapting the stations. The second group of stakeholders refers to public decision makers. Each public decision makers is in charge of a specific transport policy but they have to coordinate their decisions:

- The Grand Lyon is in charge of urban mobility plans, urbanism, land-use planning and community facilities.
- The SYTRAL is the Organizing Authority for urban public transport of Lyon that represent the Urban Community of Lyon and the Rhône department
- The Rhône-Alpes region is the Organizing Authority for regional (rail) transport
- The Rhône department is the Organizing Authority for departmental transport

The main operator involved in the Part-Dieu station is the SNCF, the only rail operator. We can associate RFF, owner and manager of the French railway network. If RFF is not directly involved in the station development, is in charge of developing railway structure. Two other operators are also identified : Kéolis Lyon, the urban public transport operator, and Véolia Transport, the RhôneExpress operator. Transport operators are linked to one or more organizing authority by

a contractual relationship. The contract determines, among other things, characteristics of the public transport supply.

The last group refers to user associations. The two main ones are the “National Federation of the Transport User’s Association” and “To travel differently in the Lyon Metropolitan Area” but rail lines committees are also influential. These associations are public transport lobby groups representing public transport passengers.

6.5.3.1 *The stakeholders from an Agents perspective*

Three main categories of agents have been identified in the Part-Dieu case study:

- The terminal manager
- Public decision makers
- Users (with users’ associations)

Transport operators, also using the Part-Dieu station are not really involved in the inter-modal transfer issue.

6.5.3.1.1 Objectives and Goals

Terminal manager aims to improve transport operators and passengers welcome. To achieve this objective, terminal manager provides and maintains facilities, equipment and information to transport operators and users. The transfer time minimization and the in-station passenger flow management are two key intermediate goals.

Public decision makers, in charge to define –and to finance- transport policies aims at improving intermodal transport. To achieve this goal, they have to reinforce public transport networks integration and coordination.

Part-Dieu station users aim at decreasing modal or intermodal transfer time and improving waiting and transfer time quality with appropriated facilities and equipment.

6.5.3.1.2 Strategies

To achieve transfer time minimization and in-station passenger flow improvement, terminal managers can implement passenger traffic lanes. These traffic lanes should be clearly delimited with stopping areas. Visual signs and/or personnel should be used to inform the Part-Dieu station user.

Part-Dieu station user could adopt a new strategy changing departure and/or arrival time in the Part-Dieu station for non-constrained trips. First, they don’t suffer any more from passenger traffic congestion and then, they limit congestion in peak-hour. Another strategy, more radical

than previously, consists in changing the departure/arrival station. Indeed, most of short and long distance trains serve both the Part-Dieu station and the Perrache station. The last station is not congested and is also linked to metro, tram and bus network.

The strategy of public makers is more complex. It consists mainly in coordination between urban, departmental, regional and national transport policy makers to limit transport network development around the Part-Dieu station and therefore the station-crossing by public transport users. Another strategy, not really feasible today, is to extend the station with an underground level.

6.5.3.2 *Interactions between agents*

From \ To	Terminal Manager	Public Decision Maker	Users
Terminal Manager		Cooperation Negociation	Cooperation Commercial relationship (indirect)
Public Decision Maker	Cooperation Regulation Hierarchical relationship		Electoral Commitments
Users	Cooperation Negociation	Negociation (election)	

6.5.3.3 *Graphical representation*

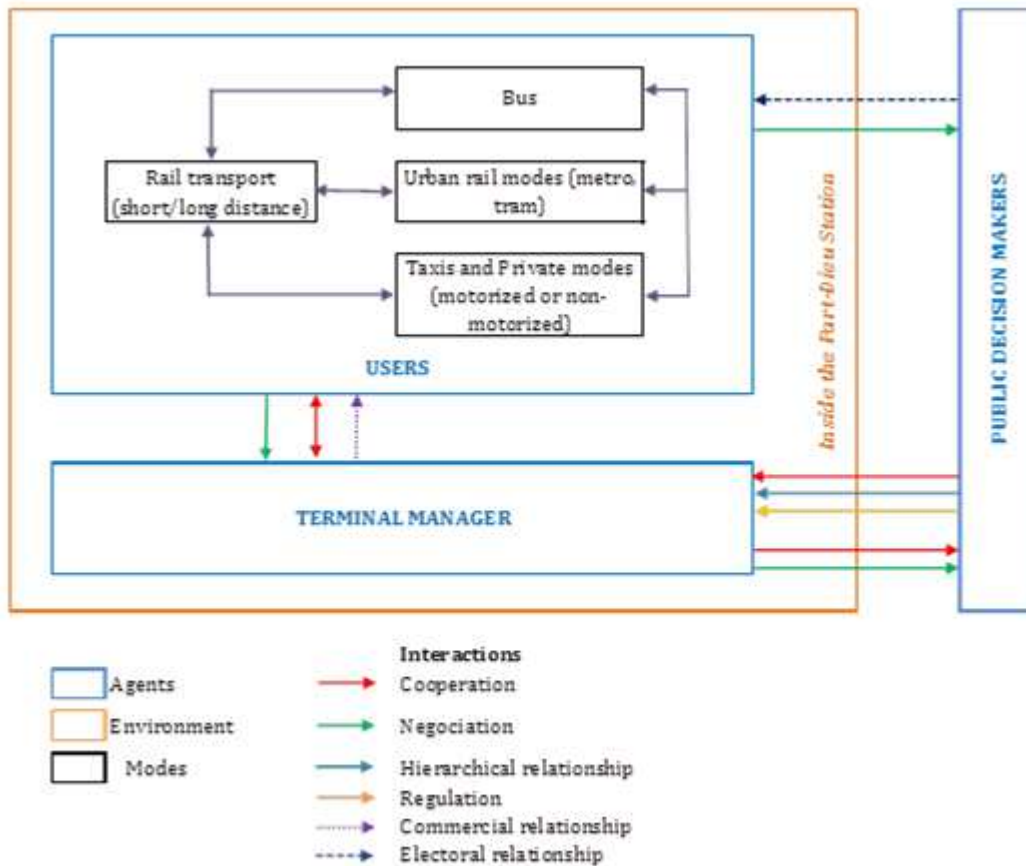


Figure 6.220 : Interaction between agents in current scheme

6.5.4 Current short-long interconnectivity problems/opportunities

6.5.4.1 Context and identified problems

The Part-Dieu station has been planned in 1983 for a daily traffic of 35.000 passengers. In 2001 its traffic hit 80.000 daily users. The number of persons using the Part-Dieu station at the end of 2008 is estimated to 135.000 per day (22,8 million per year) with among them 105.000 rail passengers (see RFF, 2011). More than one user in five crossing or spending time on the Part-Dieu station is not a rail passenger. Note that RhôneExpress shuttle carries between 1.900 and 2.500 passengers per day. In this context, the crucial point for the Part-Dieu station managers is to improve passenger quality of services and more precisely the following items:

- Passengers information (on delays, train track...);
- Signage improvement;
- Modal and intermodal transfer time improvement;
- Facilities development: shops and other services;
- Safety, comfort improvement in waiting areas;

- Cleaning and hygiene.

Linked to the saturation point of the Part-Dieu station, the variety of users with different constraints is also a specific problem identified. Businessmen bump into holidaymakers or commuters. Then occasional and regular users are observed. Needs and expectations of these different passengers are different. While holidaymakers often have a low value of time when they cross the station, businessmen with a high value of time try to limit their connection time.

6.5.4.2 Architecture and physical organisation: a current critical factor

The 8,348 m² of Part-Dieu station have been built following a two-level configuration. Two main entrances are located on its West side (Vivier Merle entrance) and on its East side (Villette entrance). The station entrances are on the ground floor where station facilities (booking office, convenience stores, waiting rooms ...) are also located. All station users (rail passengers or not) have to enter or to cross this station concourse. Platform, raised on the first level, can be reached by stairs, escalators and elevators. The station is composed by 5 platforms and 10 tracks.

The Part-Dieu station is served by urban public transport lines (bus, metro, tram-lines) both on its east and west sides. Tram-line T3 and RhôneExpress shuttle terminus are on the east side while bus, tram-line T1 and subway line stops are on the opposite side. This configuration force T3 and RhôneExpress users to cross the station to join the subway or other lines.

6.5.4.3 Transport networks development: a future critical factor?

According to forecasts, the number of daily passengers should increase to 130,000 in 2013 and 156, 000 in 2020 (see RFF, 2010). Such an increase can be explained first by a higher demand for short rail trips from or to Lyon, mainly for home to work trips. Between 2004 and 2009, short rail trip demand has increased by 7% per year and the tendency should continue (an increase hypothesis of 4.8% until 2030 is announced by RFF). Short rail trip demand explosion is linked to three factors:

- Urban and suburban configuration tends to favor short rail trips with travel distances inferiors to 100 kilometers and a possibility of flow organization in a "hub and spoke" model;
- An intermodal scheme development as presented in section 6.5.4;
- A short rail transport supply development with the implementation since December 2009 of a train every thirty minutes from Lyon to main regional destinations.

The second main factor explaining an increase of the Part-Dieu station daily passengers is the long distance rail network improvement. The rail network in the Lyon metropolitan area will be impacted by new long distances rail lines. Three main projects are planned for the 20 next years. The 1st phase of the both fret and passenger Lyon-Turin line – this project should be ended

closed to 2030- and the Rhin-Rhône high speed infrastructure put into service at the end of 2011. These two projects are leaning back against the “Lyon rail by-pass” to improve free flow.

6.5.4.4 *An improvement program as a possibility to limit congestion*

To prevent from a saturation increase and to renovate the station, a multi-phased improvement program is planned (origin: RFF):

- Phase 1 (2010): traffic flow improvement with passenger walking lanes, new platform access and signage improvement scheme. A new passenger rail track – at the eastern part of the station- will be put into service at the end of 2011. This is the eleventh track of the station. Previously it was only a “service track” used for fret.
- Phase 2 (from 2012-2013): central walking lane widening, east entrance improvement, new track development, plan to improve intermodality on the station neighbourhoods;
- Phase 3 (long term): total renovation and re-development of the station with the “Lyon rail node” implementation.

6.5.5 **Current value proposition**

The Part-Dieu station has four main Value Propositions that rely four main capabilities.

1/ The main attraction and value proposition of the Part-Dieu station is to welcome rail operators (mainly the SNCF) to provide regional, national and high-speed rail transport services.

2/ More generally with the intermodal transport development, the second value proposition is to attract non-rail transport operators and to propose a multimodal mobility. The Part-Dieu station proposes connections between rail transports, urban public transports, non-urban public transports (mainly with the RhôneExpress shuttle), cars and self-service bicycles

3/ In the context of rail traffic passenger increase and intermodal transport development, one of the Part-Dieu station objective is to improve quality of the services for passengers. This quality includes passengers’ information (on delays, train track...) in the station but also real-time remote information, signage improvement for different transport modes, shops and other services, a modal and intermodal transfer time improvement (with a better organisation of traffic flow), safety, comfort improvement in waiting areas, cleanliness and hygiene. “Gare & Connexions”, the Part-Dieu station owner has built a “10 promises services” project and 4 of these 10 guarantees refers to users information:

- 1/ You are informed on facilities proposed at the station
- 2/ You can easily find your way
- 3/ Intermodal interconnections are easy

4/ You are informed on delays and traffic disruptions and alternative solutions are proposed.

4/ The Part-Dieu station offers different types of in-station services (ticket office, “Salon Grand Voyageur”) and shops.

6.5.6 Description of current business model

According to Osterwalder (2004) there are nine building blocks Customer Segments (CS), Value Propositions (VP), Channels (CH), Customer Relationships (CR), Revenue Streams (R\$), Key Resources (KR), Key Activities (KA), Key Partnerships (KP) and Cost Structure (C\$).

6.5.6.1 Customer Segments (CS)

Four types of Part-Dieu station customer segments are identified

1/ Passengers: rail passengers (high speed or national lines, regional lines), urban public transport passengers, or other passengers. Passengers can be divided in various segments with intra-modal passengers (rail/rail passengers, public transports /public transports passengers), inter-modal passengers (rail/public transports passengers, rail passenger/car user, rail passenger/walker, metro/shuttle passengers...), or to a lesser extent a mono-modal user (walker, for example). A great customer heterogeneity is observed within the Part-Dieu users. Businessmen bump into holidaymakers or commuters. Then occasional and regular users are observed. The passenger customer segment can be seen as the mass market with diversified profiles.

The number of persons using the Part-Dieu station at the end of 2008 is estimated to 135.000 per day (22,8 million per year) with among them 105.000 rail passengers.

The two-third of the rail station users (bus, metro and tram-lines users are excluded) are short distance users. Figure 6.221 gives the repartition of short users destinations (See RFF, 2011):

Origin - destination	Part (%)
Lyon - Saint-Etienne	30%
Lyon - Grenoble	18%
Lyon - Bourg en bresse	12%
Lyon - Mâcon	12%
Lyon - Valence	9%
Lyon - Roanne	8%
Lyon - Chambéry	6%
Lyon - Annecy	5%

Figure 6.221: Short rail distance destination

A variety of users with different constraints uses the station : businessmen bump into holidaymakers or commuters. Then occasional and regular users are also observed.

2/ Railway companies are the main terminal manager clients. They access to the facilities and equipment in the station to operate passenger train services. The main railway company client is the SNCF. This segment represents a niche market.

3/ Non-rail transport operators are the third customer segment. The Part-Dieu station can provide in-station facilities, specific signs, and passenger information to allow non rail public transport operation. Two non-rail operators are present at the Part-Dieu station: Keolis Lyon which operates urban public transport lines and Véolia which operates the RhôneExpress shuttle.

4/ The last segment is trading partners like everyday shops, gifts shops, or firms... which rent out retail unit space or offices at the heart of the Part-Dieu station.

6.5.6.2 Value Proposition (VP)

The Part-Dieu station has four main Value Propositions referring to different customer segments. These VP rely four main capabilities.

1/ The main attraction and value proposition of the Part-Dieu station is to welcome rail operators (mainly the SNCF) to provide regional, national and high-speed rail transport services. The rail service presents mainly two travel classes. The second class, the cheaper, and the first class. The first class is mainly in long distance used for professional trips (for example, between Lyon and Paris). Passengers with a “Grand Voyageur” season ticket can access to “Grand Voyageur’ lounges, in particular in the part-Dieu station (note that these lounges are not offered in every station and Perrache, the 2nde highest station in Lyon doesn’t offer this facility). The “Grand Voyageur’ lounges offer an internet access, magazines and newspapers, desks... The first class also exists for regional trains (short rail distances) but is not really used. Note that more and more regional trains only propose one passenger class.

2/ More generally with the intermodal transport development the second value proposition is to welcome non-rail transport operators to propose a multimodal mobility. The Part-Dieu station proposes connections between rail transports, urban public transports, non-urban public transports (mainly with the RhôneExpress shuttle), cars and self-service bicycles. In urban transports, only one class is proposed to passengers.

3/ In the context of rail traffic passenger increase and intermodal transport development, one of the Part-Dieu station objective is to improve quality of the services for passengers – including for disabled people who access all modes and trains (long distance, short distance and urban distance). This quality includes passengers’ information (on delays, train track...) in the station but also real-time remote information, signage improvement for different transport modes to reduce in-connection time, shops and other services, a modal and intermodal transfer time

improvement (with a better organisation of traffic flow), safety, comfort improvement in waiting areas, cleanliness and hygiene.

4/ The Part-Dieu station offers different types of in-station services (ticket office, “Salon Grand Voyageur”) and shops.

The main reasons for passengers to choose this company over another (the Lyon Perrache station, for example), can be divided into five classes:

- the number of rail connections proposed in the Part-Dieu station either at a regional level, or at a national or international level
- the number of urban connections proposed at the station
- the location of the station in a business area. Due to its location, job accessibility from the Part-Dieu is the higher of the Grand Lyon area.
- the shopping center nearness;
- facilities proposed at the station

The Part-Dieu station service level is measured by transport services and transport associated services. Transport service is linked to the following items:

- the number of trains (and their passengers capacity) crossing or stopping in the station;
- the train punctuality

Transport associated services are the following:

- waiting rooms and their seating capacities;
- shops and facilities proposed to users;
- space devoted to passenger traffic;
- cleanliness of the station.

6.5.6.3 Channels (CH)

The Part-Dieu station offers its Value Propositions through different distribution channels.

1/ The first distribution channel, at passengers destination, is the transport operators (rail or non-rail operators). Operators are thus considered as passengers interface elements. Most of time a passenger uses the Part-Dieu station because he has to take a train or another mode.

2/ The second distribution channel refers to the web-site <http://www.gares-connexions.com>. This web-site provides many information on the Part-Dieu station organisation, mainly for the rail user point of view. It also offers a real-time information board for departure and arrival times.

3/ The third distribution channel refers to Medias (magazines or different medium of communication).

Train tickets are sold by four different distribution channels:

1/ The first one, the least used, corresponds to travel agencies. This channel is mainly used by companies for (long distances) professional trips but individuals for commuting or leisure travel don't use it.

2/ The second channel is the SNCF web-site (www.voyages-sncf.com). The web-site use is increasing and people buy more and more long distance rail tickets by the site. Using the web-site they can also print their ticket at home, pick up the ticket at a counter or have their tickets sent at home.

3/ The third channel is the counter in station. At the Part-Dieu station, counters are opened from 05:15 à 22:00 every days.

4/ The fourth channel refers to ticketing machines. Two types of machines are proposed in the Part-Dieu station: ticketing machines for regional travels and ticketing machines for long distance high-speed travels. With these machines, it's possible to buy but also to pick up or to exchange tickets.

Urban tickets are mainly sold by ticketing machines at the bus station but it is also possible to buy tickets at a counter office located outside the Part-Dieu station or in the bus. Note that bus ticket prices are 0.20€ higher when bought directly to the bus driver.

Nor real customer after-sale customer support is offered by the station. The only one could be the ticket exchange. To exchange a ticket, passengers can ask at the counter or using a ticketing machine dedicated to long-distance tickets.

6.5.6.4 *Customer Relationships (CR)*

A customer-orientated approach is implemented to achieve the passengers satisfaction. The passenger relationship tends to be more personal and efficient. The objective is to understand the passenger needs and requirement and to promote a positive image of the Part-Dieu station. The passenger doesn't have to waste time in station but he has to use waiting time working, doing shopping... More than in-station information, the objective is to give to the passenger real-time information everywhere owing to smartphones and mobile phones web connection.

Relationship with transport operators are established by legal framework. One of the Terminal manager missions is to make connections easier with non-rail urban and interurban transports modes (statutory order n°83-817, 13th September 1983). The Terminal manager as administrator makes rail operators respect specific rules (security, safety...) and access conditions (SNCF, 2010).

A fidelity programs is proposed to passengers by the French rail operator for long-distance trips. Fidelity program is proposed to seasonal card users like “12-25 years old card”, “senior citizen card”, “Frequency card”, “Children card”. It allows to its beneficiary to accumulate “smiles”. These smiles can be then changed into train tickets or gifts.

The Terminal Manager doesn’t manage directly trading partners relationships. A subsidiary is in charge of marking retail unit spaces.

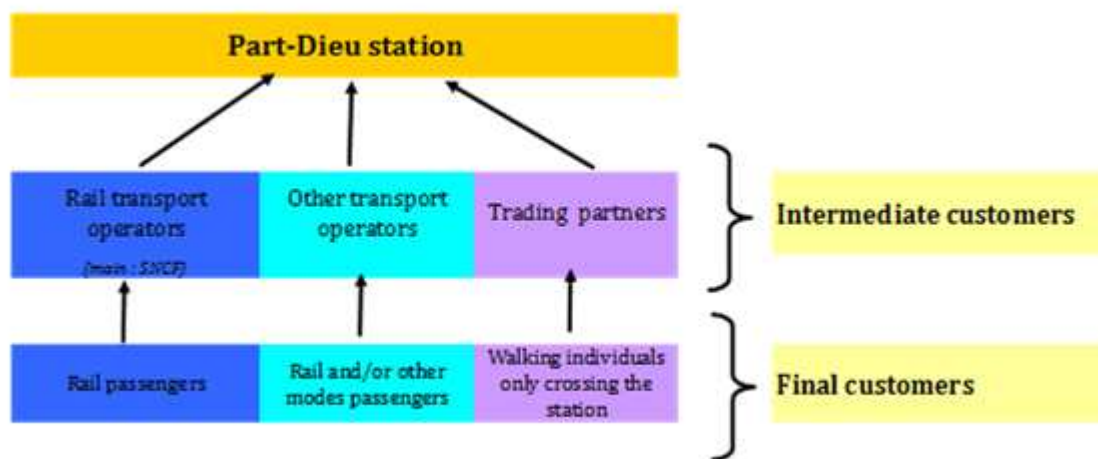


Figure 6.222 : Customer levels for the Part-Dieu station

6.5.6.5 Revenue Streams (R\$)

6.5.6.5.1 Revenue sources

We can identify two main types of revenue streams for the Part-Dieu station. Both refers to the infrastructure:

- licence fee paid by rail operators for using the station. Figure 6.223 indicates licence fees applied at the Part-Dieu station for different types of trains.

	Tariffs 2011 (€ / train at departure)
Régional - <100m	66,89
Régional - >100 et < 7 voit	72,7
Régional - >100 et > 7 voit	84,33
Longue distance - <100m	72,7
Longue distance - >100 et < 7 voit	84,33
Longue distance - >100 et > 7 voit	107,59

Figure 6.223 : 2011 licence fees for train departure at the Lyon part-Dieu station

- receipts from trading renting. The Part-Dieu station proposes trading and offices premises, advertising space etc

Revenue data are not available for the Part-Dieu station. Nevertheless, at a national scale, 66% of stations turnover is made by licence fees and 11% are from receipts from trading renting.

6.5.6.5.2 Ticketing scheme

6.5.6.5.2.1 Rail ticketing scheme

In long distance trains, 2 passenger classes exist. In the first class, only one price level is applied while in the 2nd class, two price levels exist : one for the off-peak period and one for the peak period.

Various seasonal cards are offered to passengers (the general public). They are available both on long and short distance rail lines:

- "12-25 years old cards, for people aging from 12 to 25 years old. They offer a 25% reduction in peak period and a 50% in off-peak period.
- "senior citizen cards, for people aging more than 60 years old. They offer a 25% reduction in peak period and a 50% in off-peak period.
- "Frequency cards, for people aging from 26 to 60 years. They offer between 25% and 40% reduction.
- "Children cards, for people aging from 4 to 12 years old. They offer a 25% reduction in peak period and a 50% in off-peak period.

The specific regional (short distance) rail ticketing scheme consists of 34 different tariffs. They can be grouped into 5 main categories:

- monthly or daily season ticket under the Travel for Work discount scheme
- young people season ticket
- frequency season ticket
- season ticket for unemployed people
- integrated season ticket for regional rail lines and urban public transport lines.

6.5.6.5.2.2 Urban ticketing scheme

Urban ticketing scheme consists of 6 different tickets tariffs:

- individual tickets (buying by Booklet of 10 tickets or not)
- 2 hour "Ticket Liberté", valid for travel during the 2 hours after it is first stamped, from 9am until the last service from Monday to Saturday
- One day "Ticket Liberté" valid for the duration of one day from the time it is first stamped.

- Evening "Ticket Liberté" valid from 7pm until the end of service
- Group ticket, for groups of at least 10 people from the same organisation, travelling together.
- Ticket for large families with at least 3 children under 18 years old

Urban ticketing scheme consists also of 5 different tickets tariffs:

- Season ticket
- Season ticket for people aging more than 60 years old
- Season ticket for couples
- Campus pass, for students under 28 years old

6.5.6.6 Key Resources (KR)

The Part-Dieu station, like other stations located in the French territory is the SNCF property by an affiliated company "Gares et Connexions". As explained previously, financial resources come from rail operators and rents. The French government also bring subsidies to the SNCF and therefore to its affiliated "Gares et Connexions". Human resources dedicated to the Part-Dieu station is not known today.

The whole Part-Dieu station (hall, tracks, facilities) is the "Gares et Connexions" property. Rail slots have been attached by the SNCF with the RFF agreement.

6.5.6.7 Key Activities (KA)

The key activity for the Part-Dieu station (like for other French rail station) is to authorized passenger and freight trains to cross ad stop at the station and to "access to the facilities and equipment that it manages in stations with absolute fairness. a basic service that includes:

- The provision and maintenance of buildings, facilities, equipment and services required for welcoming passengers and helping them access their train
- The operational management of in-station passenger flows
- Assistance for people with disabilities or reduced mobility to reach their train
- The provision of passenger information, both visual and audio, to help them access their train

This basic offer may be supplemented, depending on the station and railway company needs by:

- The provision of facilities and rooms in stations, for technical or commercial purposes,
- The use of train preparation air-conditioning equipment,
- Group welcome and accompaniment".

Therefore, the company's market is both at regional and national level (and at a less extend at an international level).

6.5.6.8 Key Partnerships (KP)

Two types of part-Dieu station partners can be identified: trading partners and institutional ones. Trading partners are also "intermediate" customers (rail operators, non-rail transport operators and trading partners), as presented previously. The Part-Dieu station, as a central point of local, regional and national rail traffic is inevitable for transport and urban policy planners. Therefore terminal managers work closely with institutional actors involved in transportation issues. The main are Regional Council (Rhône-Alpes Region), Grand Lyon (Lyon and 55 others municipalities), SYTRAL (Syndicat des transports en commun de l'agglomération lyonnaise). Such a partnership can be illustrated by the « Lyon railway node ». The Part-Dieu station is a blocking point of the over-congested Lyon railway node. To answer the future rail traffic demand, infrastructures as such as station and technical platforms have to be improved. Propositions have to be made not only by technical managers (RFF or SNCF) but also by local institutional actors (like Grand Lyon or Regional Council) financing a part of this project.

6.5.6.9 Cost Structure (C\$)

The cost structure is very complex and refers mainly to equipment and human resources. Access to stations for rail operators is set by SNCF using licence fees (see Figure 6.223). ARAF (the French authority for the rail activity regulation) notes that accessibility to station is a main stake for rail firms, mainly newcomers. It observes that the current situation is characterized by: an ambiguous infrastructure distribution in a competition sector between the historical rail operator (SNCF is the French stations owner and also a rail operator) and the infrastructure owner and manager RFF. Moreover tariff relationships between rail companies and infrastructure owner are not clear.

6.5.7 Current level of quality of services and customer satisfaction

In April and May 2011, 746 users have answered the survey. For each item we will present results for the total population and, if needed by customer groups.

6.5.7.1 Description general information about the passenger

6.5.7.1.1 Passenger description

In or around the Part-Dieu station, 749 persons (customers) have been interviewed with an equidistribution of men and women. Interviewed persons for the “Urban segment” survey are in majority men (53%) while women are overrepresented in “Short” and “Long distance” surveys.

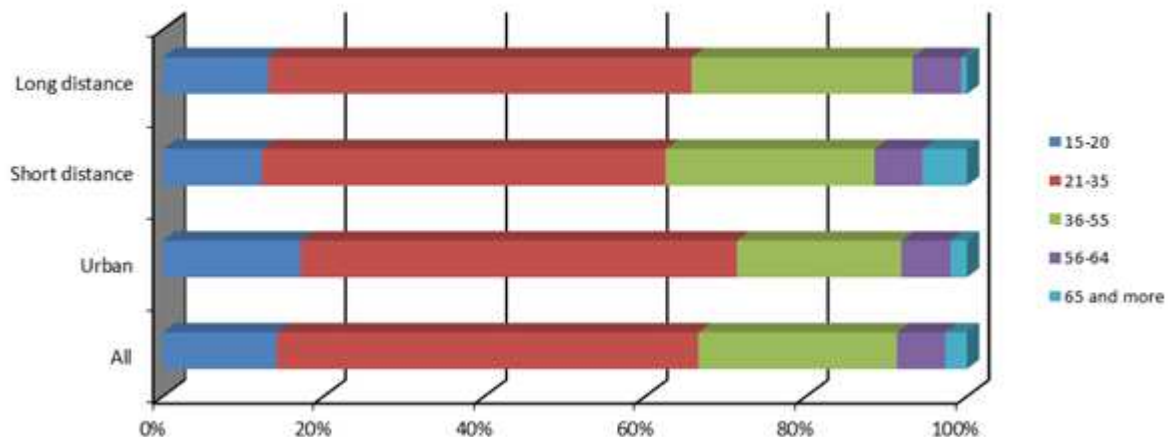


Figure 6.224 : Distribution per age

The survey respondents were broken down in 5 age categories. Population distribution per age group is more or less the same for each segment. Individuals between 21 and 35 years old represent more than 50% of interviewed while persons older than 56 years are only 10% of participants. Following instructions, the survey has been conducted only on people older than 15 years.

Professions have been divided into 7+1 categories. The total response rate for the profession group is approximately 10%. Considering the 749 persons interviewed, two categories are mainly represented: students and employees with respectively 31% and 20% of interviewed. It is interesting to note some disparities between segments. In the “Short distance” segment, no-answer rate is fairly higher (21%) than for other segments. In the “Urban” segment the category “Other”, including professions badly filled, is over-represented (24%). These two specificities can be explained by pollster’s behaviours who didn’t ask the question for the “Short distance” segment or who didn’t filled well surveys for the “Urban” segment. For the “Long distance”

segment, the higher rate of managers (17%) can be explained by business trips to Paris by high-speed trains. The high rate of student (34%) is not surprising because the survey has been partly conducted during spring holidays.

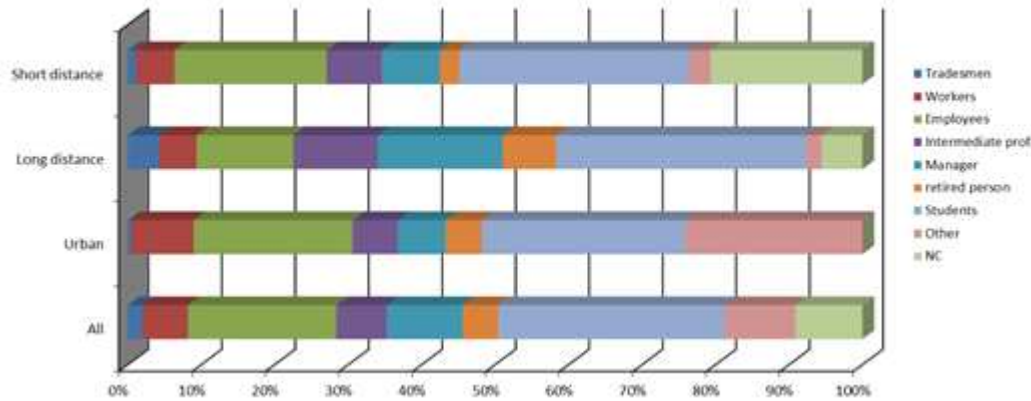


Figure 6.225 : Part-Dieu users' profession

6.5.7.1.2 Passengers' journey

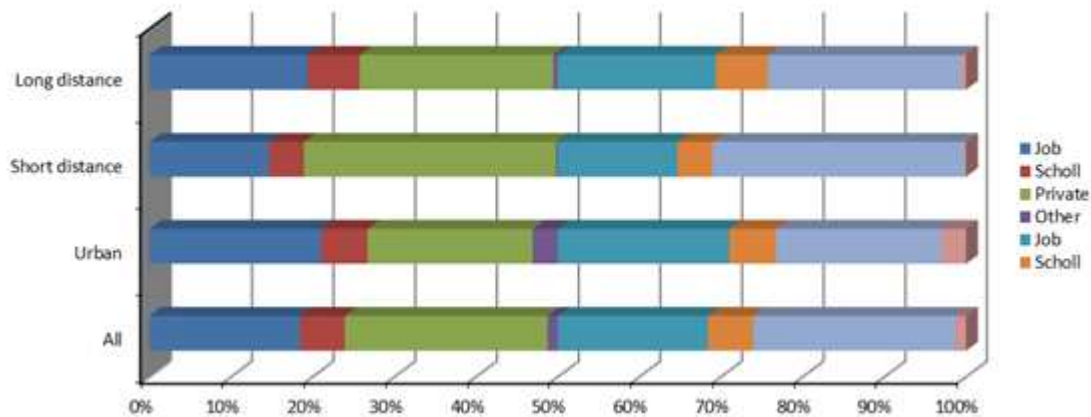


Figure 6.226 : Trip purpose of the Part-Dieu users

Two main trip purposes are observed: trips for job accounted for 37% and trip to personal business destination represent a total of 50%. Approximately only 10% of trips are made to go to school. This result is likely due to both the period of the survey (during spring holidays in Lyon) and the interviewed people over age 15 years. Short distance trips analysis underlines an under-representation of work trips (less than 30%) compared to other distances (approximately 40%). Conversely, private trips accounts for more than 60% of short distances trips while 50% when all modes are considered.

Survey participants were asked the main transport mode used for their current trip. It is therefore not surprising that mode of travel depends mainly on distance segment. More than 90% of short and long distance travelers consider that respectively regional train and high speed train are their main mode of travel. More than 70% of urban travelers answered bus is the main mode of their trip. Nevertheless 17% also consider metro or tram is the dominant mode.

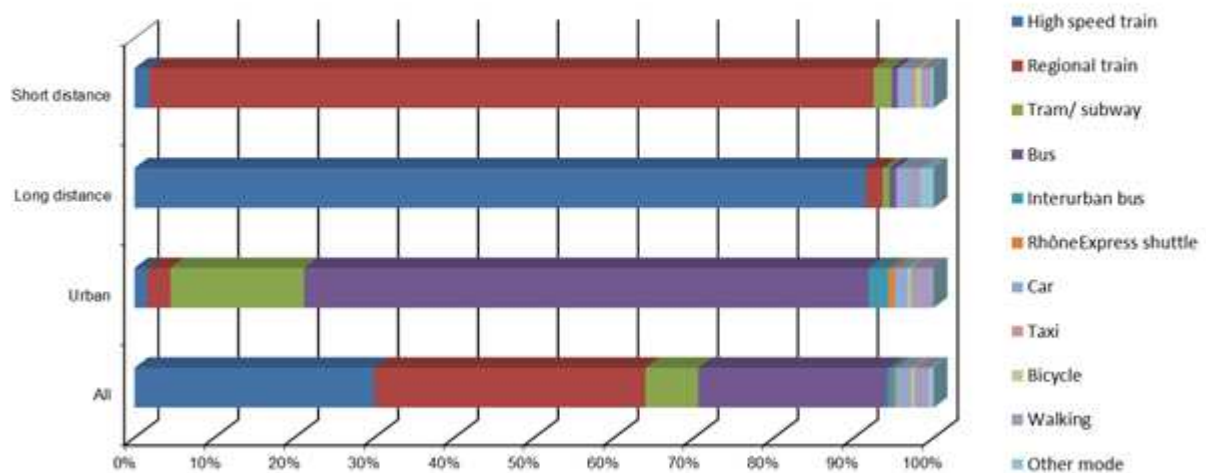


Figure 6.227 : Main mode of travel for Part-Dieu users

The city of Lyon and its suburbs (called Grand Lyon in Figure 6.228 and Figure 6.229) represents more than the two-thirds of places of trip origins. Therefore we observe the more the trip distance increases, the less Lyon is the trip origin: while Lyon and its suburbs represents 90% of trip origin in the urban segment; it is only 66% of origins in the long distance segment. The Part-Dieu station is the second connecting station in France and allows to link French and European metropolis from regional cities.

The same logic is applied for trip destinations which vary according to distances from Lyon. Figure 6.229 underlines also the main role of the Part-Dieu station in interconnectivity both between modes and “distances” with urban, regional and national lines used from the station.

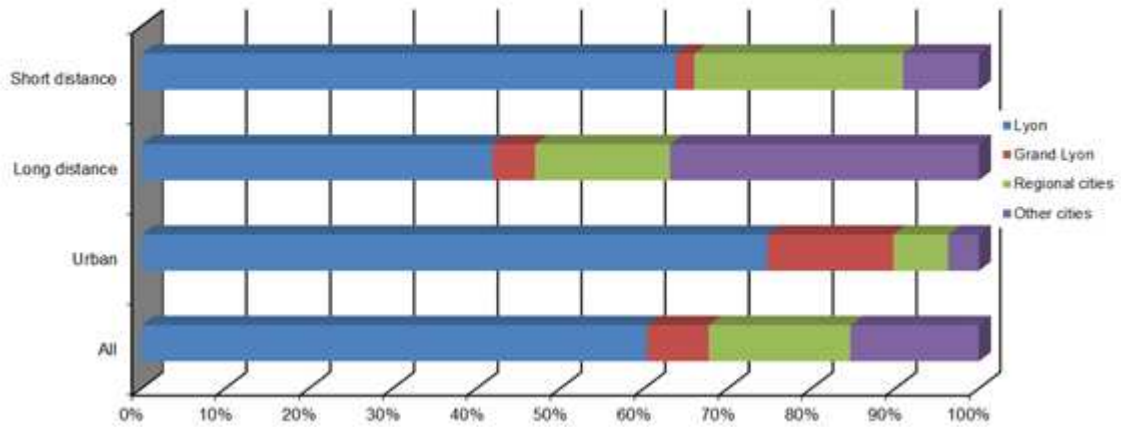


Figure 6.228 : Trip origin

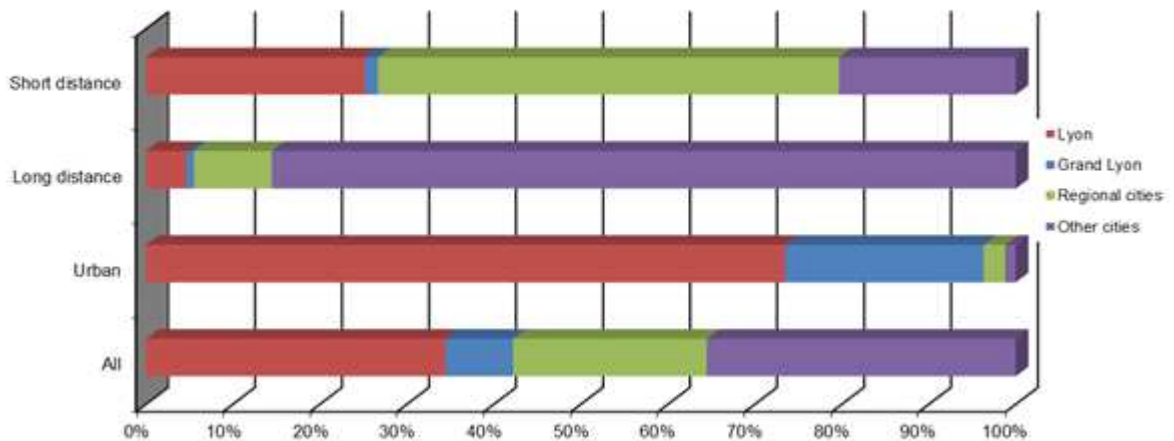


Figure 6.229 : Trip destinations

6.5.7.1.3 Travel to and from the station

This sub-section focuses on trips to and from the station according to the three different segments. We propose in a first time to answer the both questions using Figure 6.230: “How do the Part-Dieu users come to the station?” and “How long do they spent to join the station?”.

Data interpretation can be as follow: 65% of interviewed individual taking a bus at the Part-Dieu station joined it by bus or 65% of interviewed people taking a car to leave the station come from an high-speed train.

	Bus	Metro/tram	High-speed train	Regional train	Car	Other
To the station						
From the station						
Bus	65%	39%	4%	10%	5%	18%
Metro/tram	1%	0%	6%	8%	0%	1%
High-speed train	12%	18%	35%	44%	56%	31%
Regional train	20%	43%	39%	25%	37%	50%
Car	1%	0%	10%	1%	2%	0%
Other	1%	0%	6%	13%	0%	0%
	100%	100%	100%	100%	100%	100%

Figure 6.230 : Mode to travel from the Part-Dieu station according to the mode used to travel to the station

The third and fourth columns are mainly interesting because they concern the majority of the station users. We observed that most of interviewed rail users arriving in the Part-Dieu station don't use an urban or local mode (i-e bus, metro or car) to leave the station but another rail mode. Indeed, 74% (resp. 69%) of people coming to the station by high-speed train (resp. regional train) will take another train at the station. Certainly these data can be explained by the spring holidays behaviour but it underlines the connecting role of the station between modes but also between regional and national rail modes. The rail mode connection can explain time to travel to the station higher than 30 minutes : 11% and 36% of regional and high speed train users spend a travel time higher than 60 minutes to come the station. This share amounts only 4% for urban modes users.

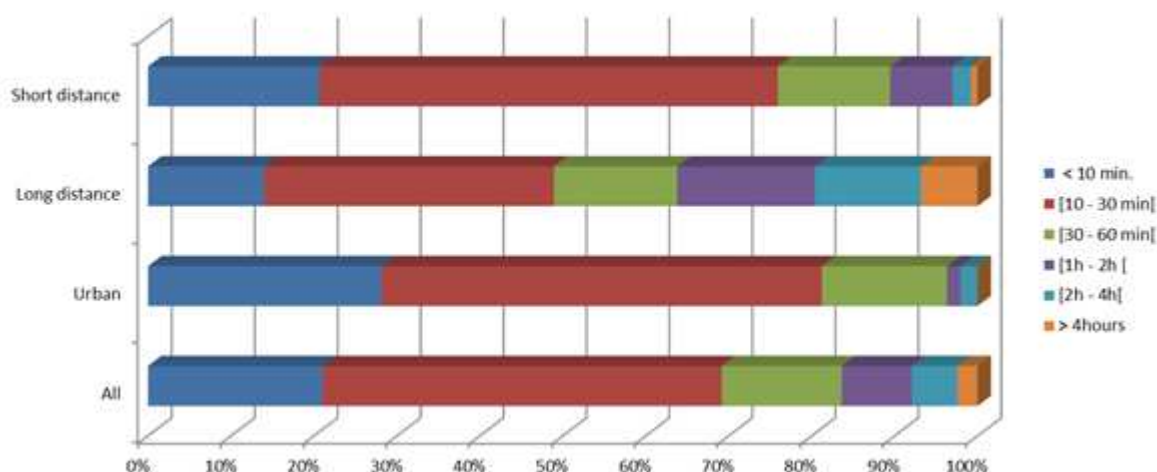


Figure 6.231: Time for travelling to the station

	Bus	Metro/tram	High-speed train	Regional train	Car	Other	
To the station							
From the station							
Bus	47%	37%	1%	5%	1%	9%	100%
Metro/tram	12%	6%	24%	53%	0%	6%	100%
High-speed train	11%	21%	13%	25%	12%	18%	100%
Regional train	13%	37%	11%	11%	6%	22%	100%
Car	10%	0%	70%	10%	10%	0%	100%
Other	10%	0%	19%	71%	0%	0%	100%

Figure 6.232 : Mode to travel to the Part-Dieu station according to the mode used to travel from the station

As previously, we propose now to answer the both questions using Figure 6.232 and Figure 6.233: “How do the Part-Dieu users leave to the station?” and “What time do they spent to join their final destination?”. Analysis focuses mainly on the third and the fourth lines corresponding to individuals taking a (regional or high-speed) train from the station. More than 20% of regional train users are in a rail connection in the Part-Dieu station. Only 50% of interviewed individuals take a bus or a light rail mode after they arrived by rail at the station. This result is still more important considering high-speed train users: a quarter of them come to the station by regional line and 12% by another high-speed line. Less than 35% use urban or light rail mode from the station. The type of travellers using the more the car from the Part-Dieu is the high-speed train users may be due to their high income and value of time. Time from the station to final destination seems to be higher than time for coming to the station. Referring to interviewed persons, the Part-Dieu station seems to be nearest from the origin than to the trip destination. Moreover, individuals may tends to over-estimate time for coming trip than for realized one.

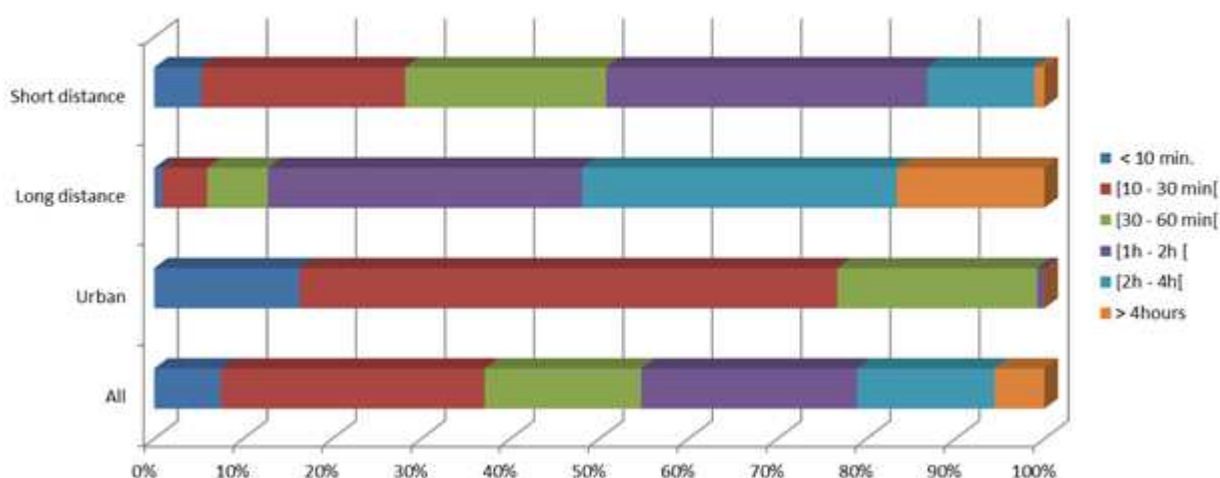


Figure 6.233 : Time for travelling from the station to final destination

6.5.7.2 Travel demand/Passenger flow

The level of daily traffic is estimated to 135,000 daily users (with 105,000 regional or national rail lines users) while the Part-Dieu station has been planned for 35,000. If we consider only rail traffic, number of users is three time as high as estimated. Therefore quality of service is felt by stakeholder and particularly users. Nevertheless, this user dissatisfaction on travel supply does not appear on “transport mode combination” and “travel connections” items. About 70% of individuals are satisfied with transport modes combination. As presented in Figure 6.234 this is in the “short distance” segment where users are the more dissatisfied (12%) or neither satisfied or dissatisfied (16%).

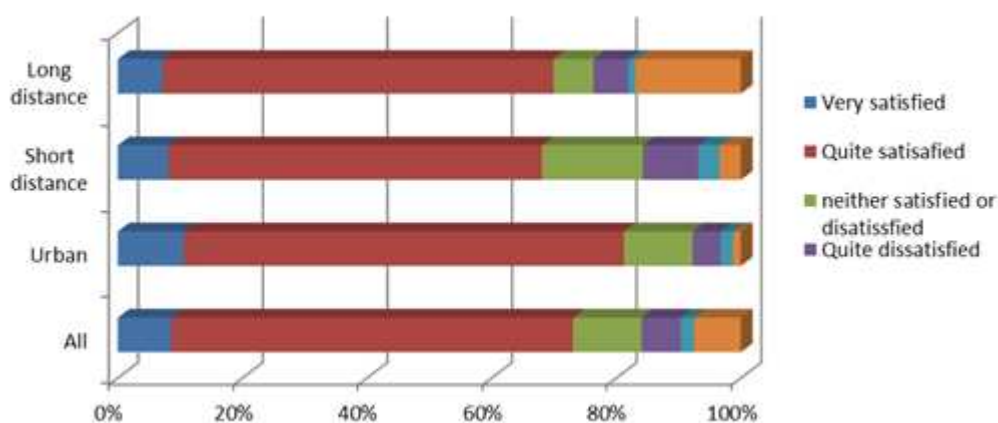


Figure 6.234 : Satisfaction level with transport modes combination

The same distribution is observed concerning level of satisfaction with timetable co-ordination even if the rate of satisfied users is slightly lower than previously (63% versus 73% for transport mode combination). As presented in Figure 6.235, share of dissatisfied people is higher in the evening peak period compared to other satisfaction levels. Nevertheless this result should be analysed with caution because 53% of interviews has been made between 17:00 and 21:00.

	All day	06:30 - 10:00	10:00 - 17:00	17:00 - 21:00
Neither satisfied or dissatisfied	100%	2%	48%	50%
Very dissatisfied	100%	0%	34%	66%
Quite dissatisfied	100%	2%	46%	52%
Quite satisfied	100%	4%	44%	52%
Very satisfied	100%	4%	39%	54%
No opinion/do not know	100%	18%	24%	58%

Figure 6.235 : Satisfaction level on transport mode combination according to period of the day

Four main factors tend to influence the choice of transport mode, whatever the segment considered: travel time; punctuality; comfort and environmental reasons (see Figure 6.236). Long and short distance users mainly favour comfort while urban users declare travel time and environmental reasons as their main influencing items.

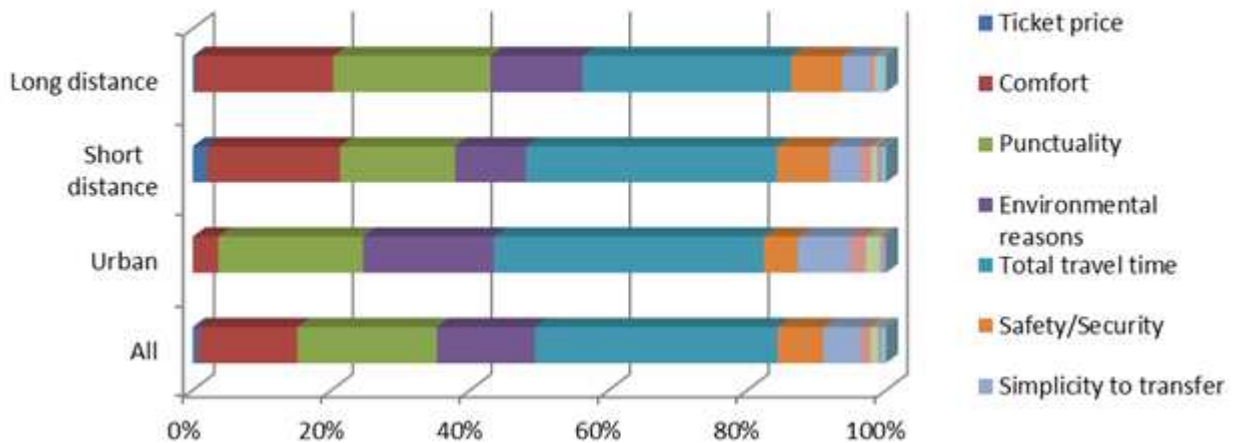


Figure 6.236 : Main factors influencing transport modes

6.5.7.3 Time

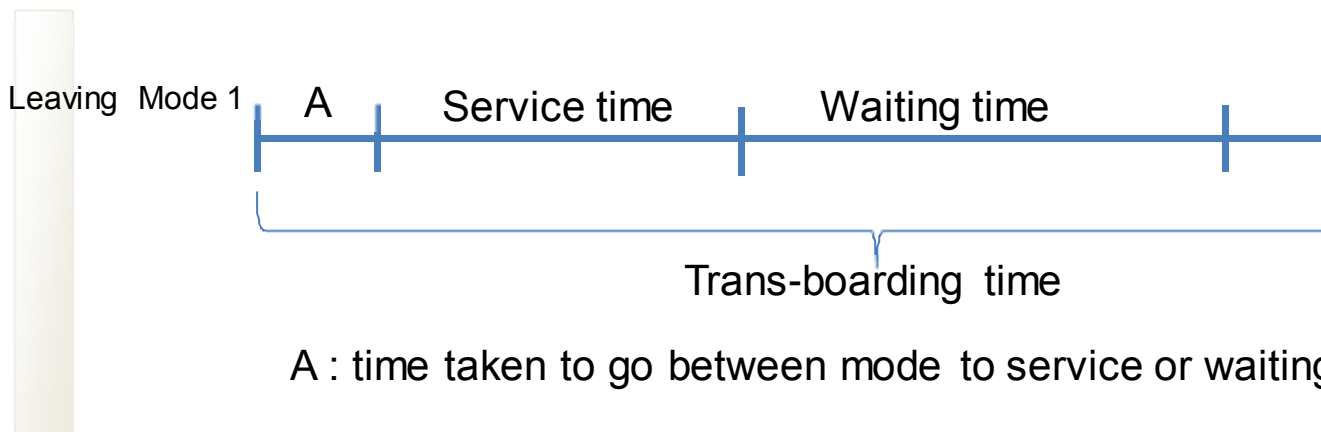


Figure 6.237 : Time division

6.5.7.3.1 Service time

Not considered in the Part-Dieu station case study.

6.5.7.3.2 Waiting time

As expected waiting time in the Part-Dieu station depends mainly on distance segments. While 91% of interviewed people on urban practice stay less than 15 minutes on the station; there are respectively 59% and 16% in “Long distance” and “Short distance” segments. Regional rail users tend to stay longer in the station than national rail ones : 47% short distance interviewed people have a waiting time higher than 45 minutes versus 8% for long distance ones. Two factors may contribute to explain this result:

- About 50% of regional rail users have taken the rail for a leisure purpose. Most of them don't take usually regional train and may prefer taking a long precaution time.
- The share of interviewed people having a train delay amounts 18% for regional lines while only 12% for national lines. About 67% of regional train delays is estimated between 5 and 15 minutes.

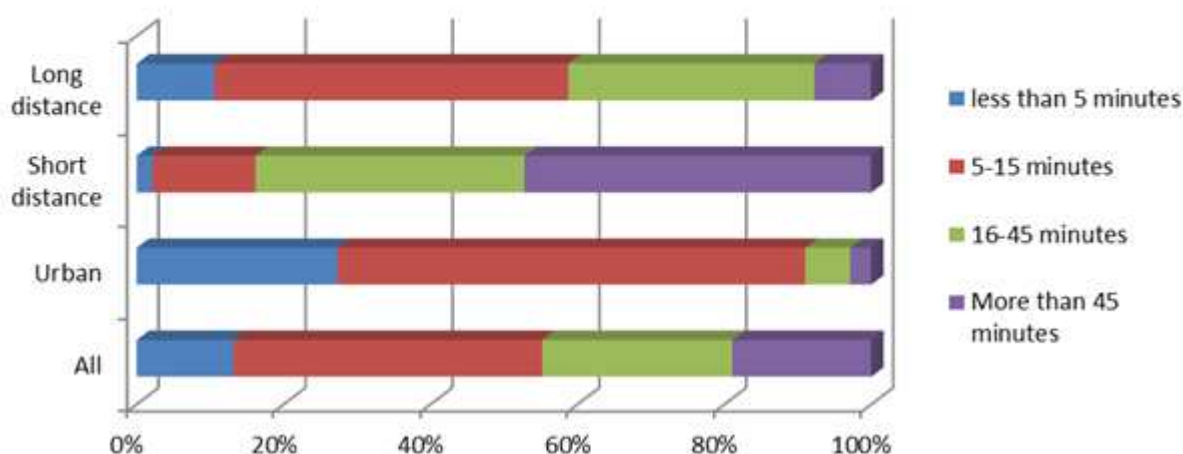


Figure 6.238: Time spent in station

The satisfaction level about waiting time amounts 36% - all passengers considered. Urban lines users are the most satisfied – but their waiting time is the lowest. The most dissatisfied users are long distance one with a 37% dissatisfaction rate. This data confirms these passengers with high income and value of time are more demanding with possibilities supplied to make profitable use of waiting time.

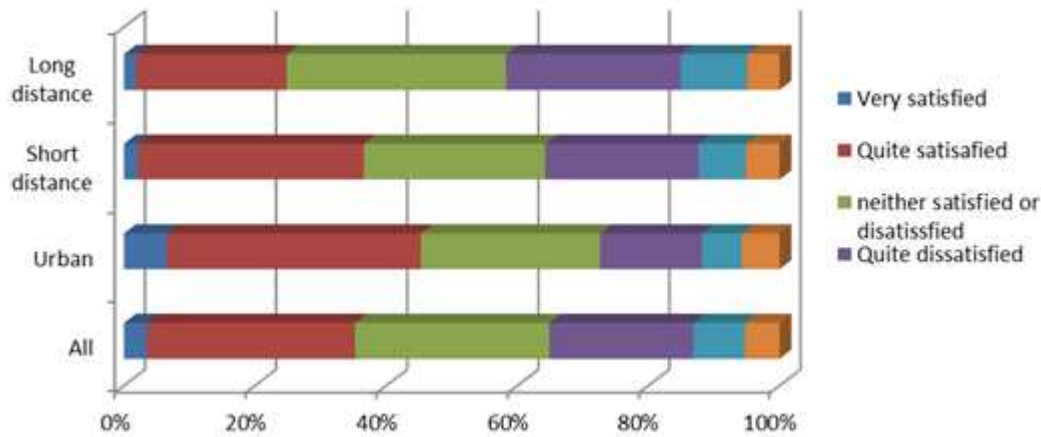


Figure 6.239: Satisfaction towards possibility use of waiting time

6.5.7.3.3 Trans-boarding time

Not considered in the Part-Dieu station case study.

6.5.7.4 *Space*

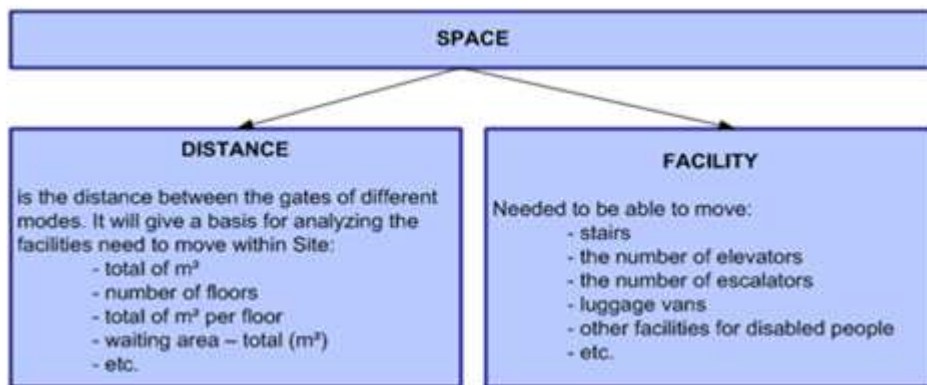


Figure6.240: Space as the measure of the quality of service

6.5.7.4.1 Distance

6.5.7.4.2 Space description:

The Part-Dieu station 8 348 m² is built on 2 floors. The ground floor is dedicated to information kiosks, selling counters (tickets) other facilities as shops, toilets.... The 1st floor is dedicated to tracks. The main waiting area is located on the hall and proposes 37 seats. Porch roofs and shelters with seats are proposed on tracks.

Distances between tracks (connection between regional lines and or national lines) : less than 200 meters, less than 5 minutes (without congestion)

Distance between hall and bus stops : connection between regional/national lines and urban bus lines : between 100 and 150 meters, between 1 and 3 minutes (without congestion)

Interviewed people underline it's not hard to find their way in the station. Only 10% of the part-Dieu users consider it's hard to find the way in the station. Figure 6.241 shows there no correlation between answer and the use of the station. Familiar users as much as occasional ones think it is relatively easy to find their way in the station.

		Very hard	Quite hard	Neither hard nor easy	Quite easy	Very easy
Not familiar at all	100%	0%	12%	41%	41%	6%
Somewhat familiar	100%	1%	11%	24%	59%	4%
Very familiar	100%	2%	5%	13%	62%	17%
Quite familiar	100%	2%	7%	19%	56%	15%

Figure 6.241: Ease of finding the way according to the station knowledge

6.5.7.4.3 Facilities at the site

Facilities / items	Facilities offered in the Part-Dieu station
Stairs	11
Elevators	(5 inside the station to link central ground and tracks + 1 outside to link the "Grands Voyageurs" lounge)
Escalators	5 (to link central ground and tracks)
Luggage vans	0
Other facilities for disabled people	4 inclined lifts + one specific welcome point

Figure 6.242 : Facilities in the Part-Dieu station

When focusing on different space items, Figure 6.243 highlights dissatisfaction of Part-Dieu station users. Total seating capacity (in the station and on platform) and free flow are the two main dissatisfaction items with respectively more than 50% and 44% of dissatisfaction rate. Regional and national rail lines users are most particularly dissatisfied with seating capacities and traffic flow with a dissatisfaction rate amounting respectively 60% and 54%.

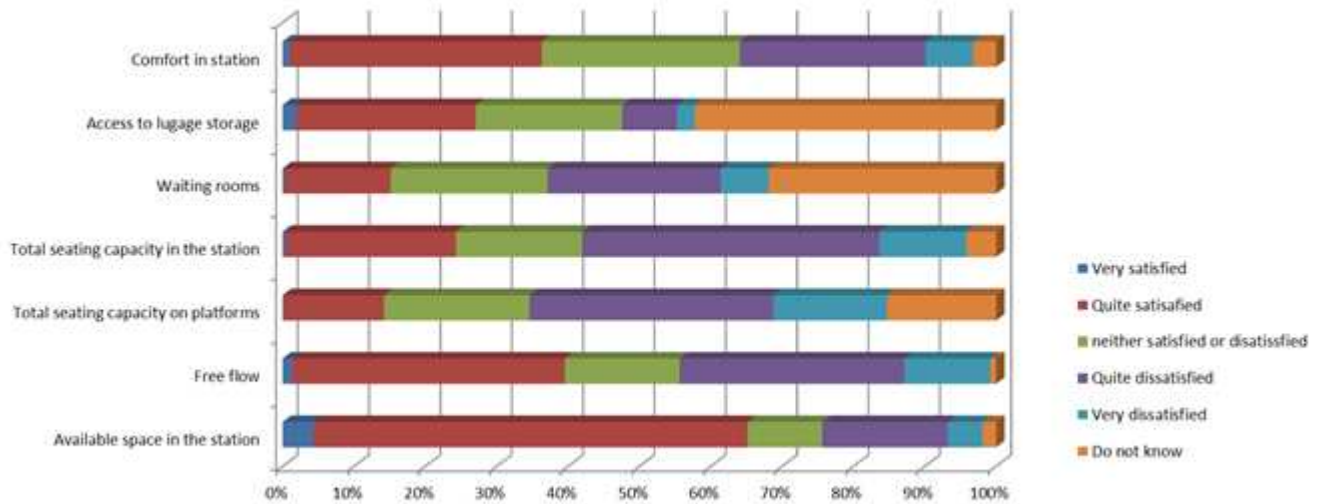


Figure 6.243 : Satisfaction level on space item

6.5.7.5 Information, Ticketing and Check-in Services

Figure 6.244 highlights two positive and two negative aspects on information and ticketing service. It appears that ticketing machines are easy to use for 70% of interviewed people and personnel at counters is very kind to answer the users questions. Nevertheless for more than 35% of users, it is not easy to buy tickets on counters. This dissatisfaction rate may be explained by waiting time in queue to obtain a ticket at counters, mainly in peak hours. The second negative aspect refers to the availability to reschedule ticket: if only 28% of users are satisfied on rescheduling tickets, 40% of passengers have no opinion on this point – maybe because they haven’t ever had to reschedule tickets.

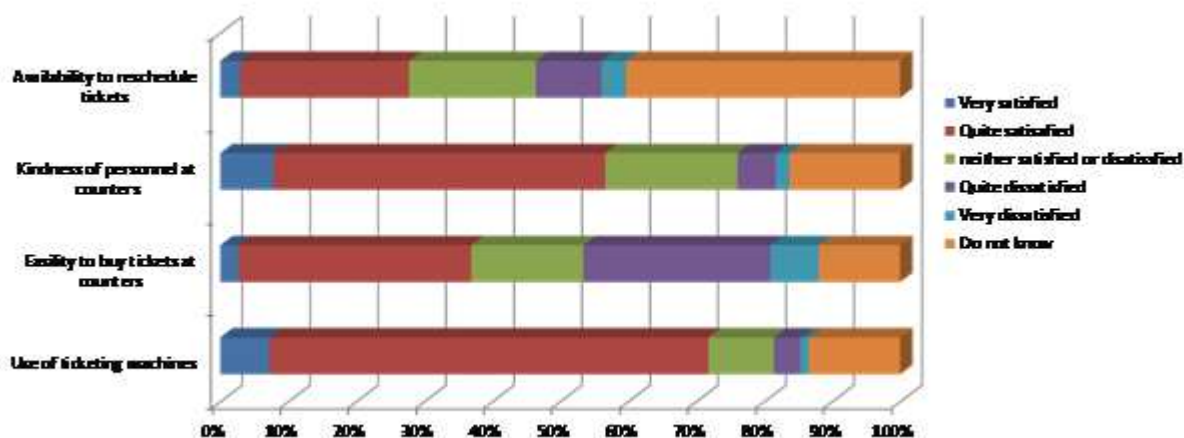


Figure 6.244 : Satisfaction levels on information and ticketing service

An integrated tariff has been implemented since 2007 to couple urban and regional lines seasonal tickets on the same card. As illustrated in Figure 6.245, more than an half of regional rail users do not know this integrated tariff: maybe they don't be concerned by travelling both by regional lines and public transport lines. For those who know this tariff, 55% are satisfied and 26% dissatisfied.

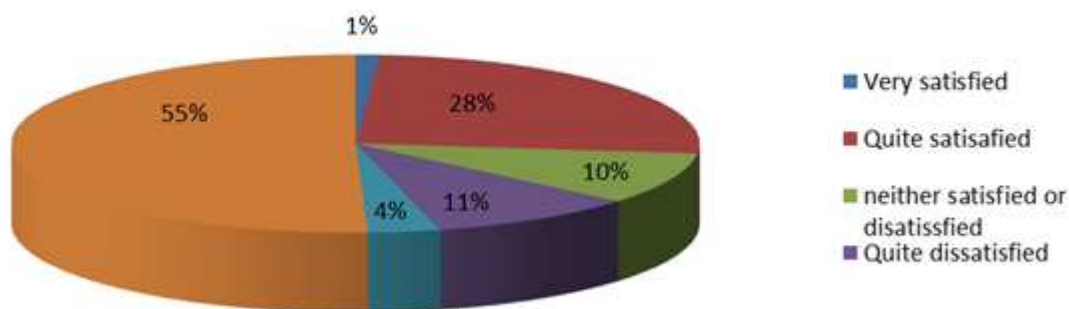


Figure 6.245 : Information on integrated tariffs (on regional rail users)

6.5.7.6 *Added value at the site*

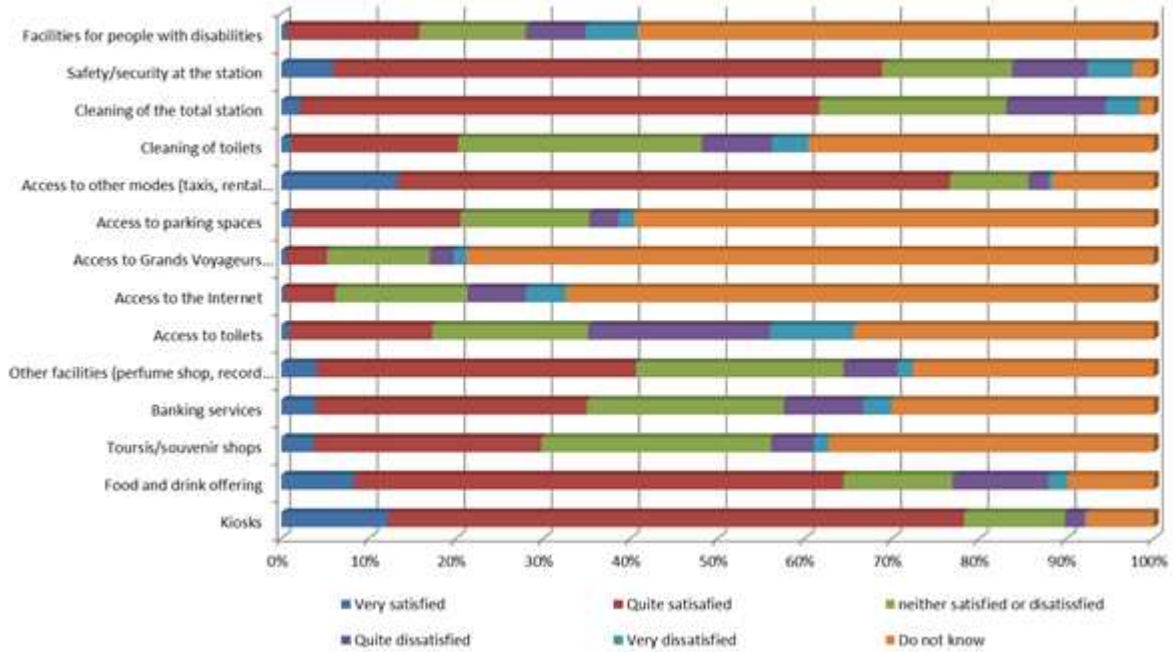


Figure 6.246 : Users satisfaction on facilities

The Part-Dieu station proposes many facilities to improve travels. Part-Dieu users have been interviewed on their satisfaction level towards these different facilities. Some conclusion can be drawn from the Figure 6.246 analysis. First, we observe a high rate of “do not know” answers (average rate of 33%). This result can be explained either by the duration of the interview (it was the last question) either because people don’t feel concerned by these facilities. Indeed, 79% of users have no opinion concerning “Grand Voyageurs” lounges because they have no access to these rooms dedicated to some users. As previously, facilities can be divided into “facilities with a positive impact on users” and “facilities with a negative impact on users”. “Positive facilities” are the safety/security; cleanness of toilets (note that toilets are paying), access to other modes, food and drink offering; kiosk with more than 60% of users satisfied. Facilities considered unsatisfactory are accessibility to toilets, cleaning of total station and facilities for people with disabilities with more 15% of users unsatisfied. Note that 14% of users are unsatisfied with “safety/security at the same” while 69% are very satisfied. People feel well concerned (positively or negatively) by the security item and only 2% haven’t an opinion on this issue.

6.5.8 Analysis for improvement of interconnectivity

The transportation and users satisfaction level collected during the survey can be explored to reveal information on how various Part-Dieu passengers segments use the station and their sentiment about time, space, information, ticketing, and other facility services.

6.5.8.1 Comparison between customers and stakeholders

Transport modes/ services	Rail services	Bus services	Car services
Geographical coverage			
Long distance services >100 km	1) International rail service 2) Interurban rail service		1) Taxi 2) Private car 3) Rental car
Short distance services <100 km	1) Metro service 2) Tram service 3) Commuter train service 4) Interurban rail service	1) Interurban bus service 2) Urban bus service 3) Shuttle service	1) Taxi 2) Private car 3) Rental car

Figure 6.247 : Different modes and capacities proposed at the Part-Dieu station

Figure 6.247 presents the different transport modes and capacities proposed at the Part-Dieu station. Three modes are offered to passenger: rail, bus and car services. While rail and, in a lesser extend car modes, are proposed at long and short distances, bus is only a short-distance mode. Note that –private or not- car services are mainly used at a short distance.

6.5.8.1.1 Travel demand/Passenger flow

Both stakeholders and passengers share the same opinion about the high passenger flow level. This passenger traffic preventing from a free flow represents a main dissatisfaction cause and, for some of passengers, can dissuade passengers from using the Part-Dieu station. Note that the more dissatisfied passengers are the long-distance ones, with high income and value of time. Often taking a very low precaution time to take their high-speed train – generally on peak hours, they are the most disadvantaged by passenger congestion. To limit congestion below arrival and departure boards, one of the two central boards has been removed for smaller boards all along the station. Moreover, to increase space dedicated to passenger traffic, le number of shops has been limited inside the station hall. Lastly, a testing has been made for delimiting passenger traffic corridors with carpets. The testing, implemented at the beginning of 2011, has not been continued.

6.5.8.1.2 Time

Passenger traffic congestion impacts waiting time and its perception by users. The limitation of numbers of shops and facilities doesn't seem to be negatively perceived by users who are, in their majority, satisfied by proposed facilities. Nevertheless, short and long distance passengers,

who spend a lot of time in the station hall, are less satisfied than urban passengers for the various possibilities to use waiting time. As they spend more time in the station, they are more demanding. Terminal managers have to balance between an increase of facilities to use waiting time – these facilities using space- and an increase of space dedicated to improve passenger traffic flow. It seems that activities and shops tend to be more and more offered outside the station than inside the hall station.

6.5.8.1.3 Space

The point of view shared by station users and stakeholders on space use is linked to the waiting time. If more than 60% of the Part-Dieu passengers are satisfied towards space available in the station, the satisfaction level decreases when space is linked to waiting time. Indeed seating capacities on platforms and in the station and space available for waiting rooms are items which highest levels of dissatisfaction (respectively 50%, 54% and 31%). Terminal managers share the same opinion than users. As explained before they have to balance between the need of passengers comfort and space available. To solve this space limitation problem, a long-term project –not yet planned but only discussed- is the creation a new underground hall.

6.5.8.1.4 Information and Ticketing Services

Information to passenger is one the main Part-Dieu issue. This is not information given to passengers taht can be at the origin of the problem but the way that information is given to passengers. Trains and bus timetables and tracks, the main information elements, are posted both on a central arrivals and departure board in the main station entrance and on small boards dispersed in the station.

6.5.8.1.5 Added value at the site

Shops, and mainly grocery and kiosks shops, proposed at the Part-Dieu station are one of the most user satisfaction items. For terminal managers they represent an interesting financial resource due to rental. The cleanliness of the station is another satisfaction point. The cleaning is subcontracted to a private company (ONET). Lastly Part-Dieu users feel safe in the station. Indeed, safety data underline that in average two complaints per day and less than five pick pocketing offences. Important measures have been taken to guaranteed users safety. A police station, run by two policemen and located inside the station, is opened every day from 04 :50 to 21 :05. The railway squad can also step in station or during railway trips. Security in the station is mainly operated by the SISTC (Interdepartmental service of public transport safety) patrols, warders from the SNCF and private officers at the station entry.

Dissatisfaction items can be classified into three categories:

- Facilities for people with disabilities: the station is guaranteed NF Services and proposes various facilities for disabled people. The origin of the user's dissatisfaction may be more explained by a lack of signage to inform users of the existing facilities than by a lack of facilities.
- Cleaning of toilets: toilets are paying and are maintained all along the day (from 06 :00 to 00 :00). User's dissatisfaction may be linked to access to toilets (see below) or a preconceived idea.
- Access to toilets, parking, « Grands Voyageurs » lounges: the dissatisfaction level on accessibility to facilities is linked to a lack of signage. Station users don't know how to access to these "facilities" and some of them don't know they exist in the station.

6.5.8.2 *Validation of findings in WP3/WP4*

Validation of findings in WP3/WP4 is made according to the Part-Dieu station terminal manager opinion and information gained with the Part-Dieu station case study analysis

6.5.8.2.1 Interconnectivity barriers

6.5.8.2.2 Institutional aspects:

- Good cooperation of between the Part-Dieu terminal manager and other actors involved
- Terminal managers and transport operators play the leading role to integrate intermodal services

6.5.8.2.3 Legal/regulatory:

- Standards on infrastructural and transport elements has been made using the SNCF (historical French operator) experience;
- Need for a regulation to homogenise standards on physical aspects, information – mainly for disabled people- and on the development of commercial activities

6.5.8.2.4 Contractual:

- No contract exists to surround information, time synchronization or safety at the interchange;
- There is no homogenisation of transport operator's contracts.

6.5.8.2.5 Information:

- Terminal manager takes the responsibility of information to various actors (passengers, transport operators, regulator body);

- High importance to develop real time information and an information system at passengers/transport operators and terminal manager levels;

6.5.8.2.6 Physical aspects:

- Need to develop/improve waiting areas, park facilities, luggage handling, sound disposing and accessibility facilities.

6.5.8.2.7 Economic aspects:

- Costs for safety/security have to be distributed between the different actors involved in the intermodal transport (administrations, authorities and operators)

6.5.8.2.8 Interconnectivity measures

6.5.8.2.9 Institutional aspects:

- Still involving public decision makers in intermodal transport services development

6.5.8.2.10 Legal/regulatory:

- Standards on physical aspects, information harmonization

6.5.8.2.11 Contractual:

- Transport operators' contracts harmonization

6.5.8.2.12 Information:

- Real time information system development

6.5.8.2.13 Physical aspects:

- Improving waiting areas, park facilities, luggage handling, sound disposing and accessibility facilities.

6.5.8.2.14 Economic aspects:

- costs sharing for parking facilities, luggage handling and security/safety

6.5.9 Missing links and new Value Proposition

Missing links can be summarized within the 6 following items:

- Real-time information system to passengers/transport operators and terminal manager on the station
- Timetable synchronization for interconnected modes

- Signage improvement to access to facilities (other than shops) and linked sound signposting
- Passengers corridors inside the station to regulate traffic flow
- Accessibility facilities – mainly for disabled persons
- Waiting time areas with seats and facilities to occupy waiting time

The new value proposition items are added in bold.

The Part-Dieu station has four main Value Propositions linked to its four main capabilities.

1/ The main attraction and value proposition of the Part-Dieu station is to welcome rail operators (mainly the SNCF) to provide regional, national and high-speed rail transport services.

2/ More generally, with the intermodal transport development the second value proposition is to attract non-rail transport operators to propose a multimodal mobility. The Part-Dieu station proposes connections between rail transports, urban public transports, non-urban public transports (mainly with the RhôneExpress shuttle), cars and self-service bicycles. **The different mode timetables are synchronized. To improve intermodal connections, a real-time information system informs you for departure and/or arrival time for connected modes.**

3/ In the context of rail traffic passenger increase and intermodal transport development, one of the Part-Dieu station objective is to improve quality of the services for passengers. This quality includes passengers' information (on delays, train track...) in the station but also real-time remote information, signage improvement for different transport modes, shops and other services, a modal and intermodal transfer time improvement (with a better organisation of traffic flow), safety, comfort improvement in waiting areas, cleanliness and hygiene. **Intermodal transfer and access to facilities are improved with both appropriated signage and sound signposting. In peak hours, passenger traffic flow in the station hall is regulated by corridors. To improve and occupy waiting time spent in the station, waiting rooms with seats are proposed.**

4/ The Part-Dieu station offers different types of in-station services (ticket office, "Salon Grand Voyageur", **web-access**) and shops.

5/ Disabled people are welcomed with dedicated facilities like escalators or lifts.

6.5.10 Actions for improvement of interconnectivity

Following paragraphs present elements added to the initial business model.

6.5.10.1 Proposal

The proposal developed in this sub-section aims to overcome the current barriers using a three-type improvement scheme. In a first time, improvement need is “physical”. It doesn’t need to high financial resources and refers first to passengers corridors implementation coupled to signage improvement and then to a waiting time areas capacities increase.

The second improvement is technological and/or technical. It is composed central by a real-time information system for passengers, transport operators and terminal manager. Its aims also to reduce differences on accessibility to facilities between disabled and non-disabled persons, with adapted equipment. Technical improvements need high financial resources.

The third improvement refers to transport system organization with a timetable for interconnected modes, mainly for short and long distances rail modes.

6.5.10.2 Description of new business model

6.5.10.2.1 Customer Segments (CS)

All customer segments are also considered in the new business model. Nevertheless, the new business model stresses mainly on intermodal regular users (whatever the distance) and disabled users.

6.5.10.2.2 Value Proposition (VP)

New value propositions always focus on improving (or reaching in peak period) seamless transfer with the following items:

- Timetables synchronization associated to a real time information system;
- Intermodal transfer and access to facilities improved with both appropriated signage and sound signposting;
- Traffic flow regulation with corridors;
- Waiting rooms number (with seats) increase;
- Web-access generalization;
- Facilities for disabled people increase.

6.5.10.2.3 Channels (CH)

Channels are the same as previously. Information using the Part-Dieu station web-site and Medias can be reinforced and used to inform users on improvements. Nevertheless, local information and visual effects on the station stay the main channel.

6.5.10.2.4 Customer Relationships (CR)

As previously, final customer relationship aims to be more and more personal to be efficient.

6.5.10.2.5 Revenue Streams (R\$)

6.5.10.2.6 Revenue sources

- Licence fees paid by rail operators for using the station. Licence fees may be increased referring to level of services offered to rail operators (real-time information system) and their passengers.
- Following new investments (real time information system, signage...), terminal manager can increase trading renting.

6.5.10.2.7 Ticketing scheme

No change is applied on rail and urban ticketing schemes.

6.5.10.2.7.1 Rail ticketing scheme

No change

6.5.10.2.7.2 Urban ticketing scheme

No change

6.5.10.2.8 Key Resources (KR)

In this new business model, the Part-Dieu station is always the terminal manager property (affiliated or to the SNCF). Resources mainly come from rail infrastructure (paid by rail operators) and in station spaces (with retail units and offices rents).

6.5.10.2.9 Key Activities (KA)

The new value propositions don't aim really to impact key activities but to improve key activities performance. Provision of equipment (for rail transport operators) and facilities (for passengers) with signage is the Part-Dieu station priority.

6.5.10.2.10 Key Partnerships (KP)

The key partner stays the terminal manager. As previously, terminal manager has to directly deal with transport operators and trading partners. In the new business model, these actors play an increasing role. They are interesting financial resource for the terminal manager and transport operators can give some advice or technical support for timetable synchronization or for implementing real-time information system.

6.5.10.2.11 Cost Structure (C\$)

In this new business model equipment and human resources are increasing as well as infrastructure ones. Equipment costs refer mainly to the real time information system, facilities

dedicated to disabled users or free web-access. Human resources are devoted to the timetable synchronisation. Infrastructures expenditures are linked to the station development.

6.5.10.3 *Description of proposed service using the concept of Agents*

6.5.10.3.1 Agents

A new agent has been added on the new business model: transport operators and trading partners. In reality, they exist in the current business model but they don't play a leading role in the inter-modal transfer issue. These two agents provide financial resources to the terminal manager and therefore constitute two assets for the station. A larger role is also given to the public decision makers for the public transport policy definition.

6.5.10.3.2 Objectives and Goals

Objectives and goals differ from different agents:

- Trading partners aim at maximising its trading revenues.
- Rail transport operators aim to increase the number of train users. They also want to increase transport quality to gain the loyalty of the customers.
- Public decision makers also aim to increase the public transport use.

6.5.10.3.3 Strategies

Terminal manager is the leading partner in the Part-Dieu case study. Each agent has to collaborate with him.

Trading partners has to cooperate with the terminal manager for many reasons:

- To negotiate rents tariffs according to the station development and its frequenting
- To attract Part-Dieu station users in their shops
- To develop their trading activity without increasing passenger traffic congestion.

Rail operator also has to collaborate with the terminal manager to improve quality of services, train regularity and punctuality. The infrastructure licence fee issue to benefit from in-station facilities and equipment is at the heart of this cooperation.

Public decision makers as public transport organizing authority collaborate with the terminal manager. An important issue in this collaboration is the financing of in-station facilities improvements. Who has to pay for planned improvements, public agents or the terminal manager?

6.5.10.3.4 Interactions between agents

To / From	Terminal Manager	Public Decision Maker	Users	Transports (Rail) operators	Trading partners
Terminal Manager		Cooperation Negociation	Cooperation Commercial relationship (indirect)	Cooperation Negociation Commercial relationship	Cooperation Negociation Commercial relationship
Public Decision Maker	Cooperation Regulation Hierarchical relationship		Electoral Commitments	Cooperation Regulation Hierarchical relationship	/
Users	Cooperation Negociation	Negociation (election)		Commercial relationship (direct) Negociation (via the PDM)	Commercial relationship (users as customers)
Rail operators	Cooperation Financial relationship	Cooperation Contractual relationship	Transport		/
Trading partners	Financial relationship	/	Commercial relationship	/	

Figure 6.248 Interactions between agents

6.5.10.3.5 Graphical representation

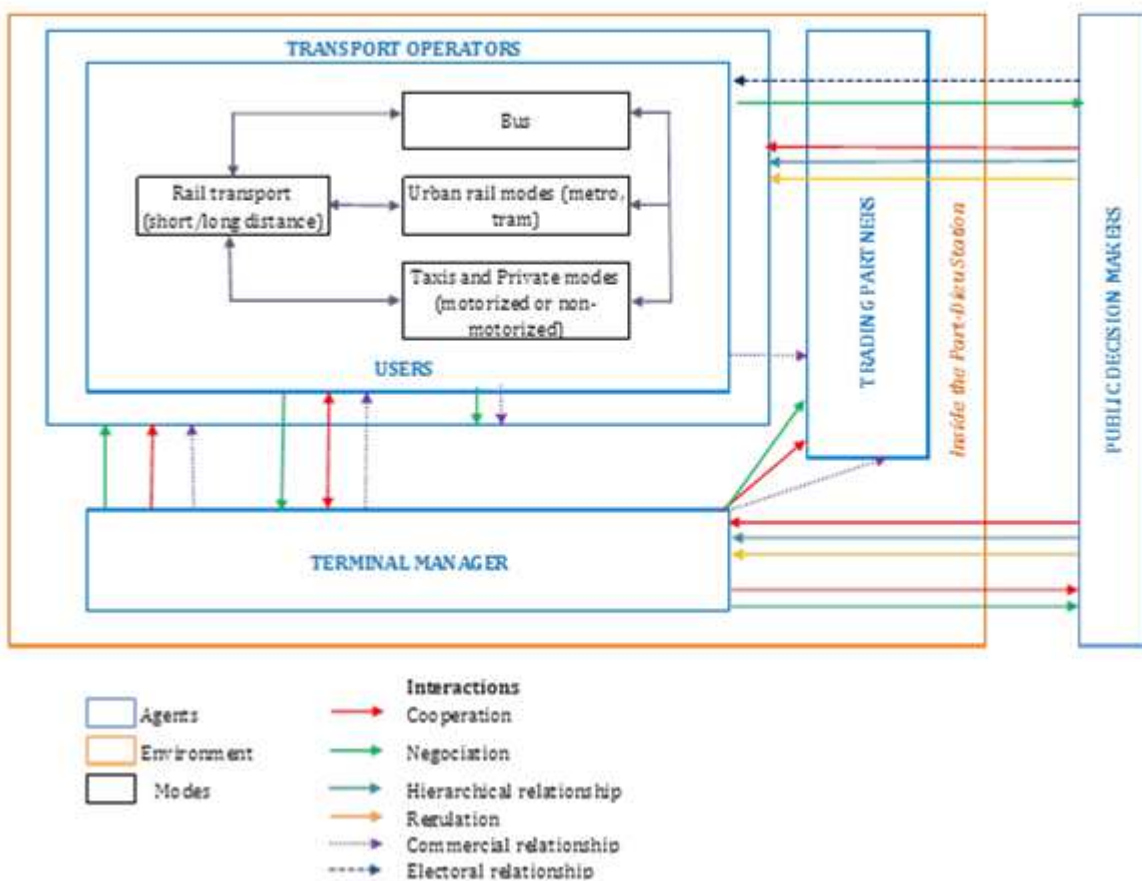


Figure 6.249 : Interaction between agents in proposed scheme

6.5.10.4 *Functions and Indicators to show enhancement*

6.5.10.4.1 Functions of validation

Many elements of change have been considered in the description of the BM. For each of them, enhancements brought by the proposal will be demonstrated as follows:

- Rail timetables synchronization benefits demonstrated by intermodal and waiting times decrease and passenger increase. The experience of timetables coordination between regional rail lines and local bus lines will be used.
- In-station signage implementation benefits demonstrated by in-station crossing time decrease;
- Agents to regulate traffic flow benefits demonstrated by in-station crossing time decrease;
- Wi-fi access generalization should be demonstrated by station users satisfaction increase;
- Real-time information system and advisory board generalization should be demonstrated by station users satisfaction increase;
- Elevators implementation demonstrated by disabled users satisfaction increase.

6.5.10.4.2 Indicators of validation

The proposal generates benefits for different types of agents:

- For users (final customers) : an important saving in time for crossing the station, comfort improvements (mainly during waiting time), real-time information on delays or travel time, security improvement.
- For terminal manager: more satisfied passengers, increase of rental resources from retails and stores and licence fees level increase.
- For transport operators: number of passengers increase and an increase of commercial resources. This objective is not the most important: daily traffic in the station doesn't stop increasing and will increase in next years with the metropolis developments and new rail lines implementation.

6.5.10.4.3 Methods and tools

The method used differs according to benefits measurements. Method and tools are described on the following items:

- Saving in time for crossing the station: “in the field measurement” is used to compare crossing time during peak and off-peak periods. It is considered that in spite of signage and agents, crossing time in peak period is always higher than in off-peak one.
- Waiting time quality improvement and therefore user satisfaction increase could be estimated with surveys implemented in similar case studies. It has not been done for the Part-Dieu station.
- Real time information benefits appear in waiting time reduction and uncertainty decrease. It could be estimated with surveys implemented in similar case studies;
- Rental resources from retails and stores cannot be estimated due to a lack of available data;
- Licence fees level increase can be simulated according to “Gares et Connexions” contracts

6.5.10.5 *Demonstration and Evidence of Improvement*

- Saving in time for crossing the station: in off-peak period, crossing time (between the two station entries) is around 2 minutes (depending if the passenger has luggage or not). In peak period, a weekly day, crossing time is measured between 3 and 4 minutes. We can consider that in peak period, signage and agents can allow to diminish crossing time of 30 seconds or 1 minute.
- Real time information benefits are estimated referring to various surveys and studies. Many of them focus on Intelligent Transportation System on urban public transit (Mishalani and al., 2006; Fries and al., 2008). A study develops the example of a real-time traveller information system implemented in 2001, in Tri-County Metropolitan Transportation District of Oregon (Cham and al., 2006), and covering all rail stops and each of the 7.700 bus stops of the district. It conclude that the system provides two main benefits for the users:
 - o Reduction in waiting time for 95% of passengers (results obtain by a survey), but reduction cannot be precisely measured. Authors underline “time savings will be more significant for those accessing real-time information via phone or internet” (p 42).
 - o Reduction in wait time uncertainty. Uncertainty can be considered as a wait time cost and refers to the attractiveness of a transportation system. No wait time reduction values can be proposed. But following Mishalani and al., waiting time in uncertainty context is $p = 1.33 + 0.92 \text{ real waiting time} + \epsilon$ with ϵ .

- License fees vary according to stations and services proposed. Datasheets from the French station owner (Gares & Connexions) presents for many French station, prices they charge. We can observe that the Part-Dieu station tariffs are very low compared to other stations. An increase of services level could allow increasing license fees and increasing resources.

	Part-Dieu station	Limoges station	Montpellier station	Marseille St Charles Station	Lille Europe station	Paris Montparnasse station	Paris "gare de Lyon" station (in Paris)
Urban - >100 et < 7 voit	66,89	73,13	116,71	146	178,11	240,17	320,67
Urban - >100 et > 7 voit	72,7	84,5	124,46	155,78	182	178,9	378,29
Short distance - <100m	66,89	73,13	139,96	146	205,33	187,71	455,1
Short distance - >100 et < 7 voit	72,7	84,5	124,46	155,78	189,78	205,19	339,88
Short distance - >100 et > 7 voit	84,33	107,24	112,84	155,78	182	187,71	378,29
Long distance - <100m	72,7	84,5	124,46	175,33	205,33	205,19	339,88
Long distance - >100 et < 7 voit	84,33	107,24	139,96	155,78	236,44	240,17	378,29
Long distance - >100 et > 7 voit	107,59	152,72	170,96	214,43	189,78	310,11	455,1

Figure 6.250 : Tariffs 2011 (euro / departure train)

source : http://www.gares-connexions.com/images/fiches_gares

6.5.10.6 Added value to the HERMES project

To introduce this section lessons learnt from the Part-Dieu case study, it should be noted that this case study is a very interesting “intermodal and crossmodal transport” case. As underlined many times in this chapter, this study develops institutional, legal, contractual, physical and business dimensions. The following paragraphs, as a conclusion of the Part-Dieu case study, will develop some main interconnectivity “nodes”, limits but also positive aspects highlights during the HERMES project. A particularly attention will be given to avoid specificities peculiar to the French legal framework and to focus only on general trends useful for all interconnectivity nodes.

The first lesson refers to the “Hub and Spoke” implementation and its consequences. Little by little, the Part-Dieu station (put into service in 1983) has become a kind of “Hub and spoke”, as many international airports. In this case, the “Hub and spoke” doesn’t refers to connections between national and international flights but between either short distance and urban trips (respectively), or urban trip and long distance trips (respectively), or short distance and long distance trips (respectively). More than 70% of surveyed users travelling from the Part-Dieu station by train (short or long distance) arrived to the station by bus, metro or tram, or train. For these users, the station is not only a train station but also an interconnection station between different public transport modes. More than the problem that the station has been built to welcome 35.000 passengers per day (compared to the 135.000 users in 2008), the Part-Dieu

station appears today as an inefficient hub. Lack of money but also a non-anticipated amazing increase of rail transport lines around the Part-Dieu station have generated a saturation point in the station. One of the most significant problem in the station is the congestion level, not only for trains –this dimension is not developed in this project-, but also for users. A kind of conflict is observed between the different types of users. Long distance train users, short distance train ones and urban network users represents each 30% of the station users (according to our survey) but each category adopt a specific attitude inside the station. Long distance users are either tourists or business travelers : most of them are used to take the train but are not daily passenger. A first conflict appears inside this travelers with a high value of time, just on time to take their high speed train – and running in the station to the track. About 60% of long distance users spend less than 15 minutes in the station. For these 60%, the station is mainly a place to take a train and activities are not really important. Regional distance users are often more regular commuter users. They spend more time in station than long distance users and tend to consider the station as a place of activities or leisure. They “enjoy” the station and their trips inside the station are not at destination of tracks but also shops and leisure activities. They can create congestion when the stroll about in the station or when they stop in front of information notice boards. The third categories, urban users, spend few time in the station : 90% spend less than 15 minutes in the station. They often only cross the station to link two different urban modes. These users want to minimize this crossing time with a fluidity of traffic. These different uses of the station generate a major traffic regulation problem: users travel with different speeds and in various directions. A lack traffic corridors combined to a lack of signage confirms the congestion feeling. To be efficient, this intermodal station should be organized in order to limit interdependency between long, short and urban distance users. If a two or three-storey station is not really possible, it should be interesting to create separated corridors or space for different users. Also, the hall should be separated between waiting spaces, main corridors to cross the station and secondary corridors to get to tracks from the station hall.

Associated to the “hub and spoke” dimension, the second lesson refers to users’ information and “training”. The “hub and spoke” dimension and the station development inside the city made the Part-Dieu station a central place of life. The station life requires to develop activities proposed inside the station. As presented by the terminal manager company’s website (Gares & Connexions), stations are not only “places on the way to somewhere” but also they boast city-centre shopping, venues for events, meetings, exhibitions...The diversity of traditional and new services proposed in the Part-Dieu station have to be highlighted. It is quite surprising that 30% of surveyed users do not know that the station proposes banking services or perfume and record shops. Also, more than 70% of users don’t know that a web-access or a Grands Voyageurs lounge

is proposed (even if it's kept for the Grands Voyageurs members program). The diversity of services and facilities proposed has to be combined to appropriated information channels. It appears that current information channels like advertising boards in station, the station web-site or some information on local Medias are not sufficient. The need to target more effectively the station users increases with the level of services, facilities but also tariffs proposed. Maybe a greater cooperation between the terminal manager and transport operators serving the Part-Dieu station could improve level of users information and therefore the level of use of facilities proposed. The lack of cooperation between stakeholders is reflected on the issue of information on tariffs. While an intermodal tariffs for short+urban distances users is implemented since 2006, more than 55% of the surveyed do not know it exist. This cooperation between transport operator and terminal manager should be combined with an in station signage improvement to reach quicker and easier facilities proposed. Information lacks on "in station" facilities proposed are emphasised when we focus on transport and timetable information. Transport information to users can be divided into two types: information in usual situation and information in disrupting situation. In usual situation, the station user needs to identify clearly its train number, departure (and scheduled arrival time), platform number as soon as possible to anticipate. This information is currently published inside the station with various departure boards, on the station web-site, on phone service and on the Part-Dieu metro station corridor. It is possible to have the updated rail information about 30 minutes before the departure and real-time information service is available on the phone. In disrupting situation, the user has to know precisely the delay, the substitution modes (if they exist) and their location (mainly if is buses instead of trains). In these kinds of situations, mainly if the disruption is not foreseen, a reliable updated and real-time information is essential. Terminal manager in cooperation with terminal managers have to reinforce the smart and mobile phone information channel. Nevertheless, information in station is essential with updated information and personnel at counters. A special organisational device with personnel for disrupted situations allows preventing users mobs and dissatisfaction.

The issue of users' information concerning facilities and travel information mainly on disrupted situation has to be combined with the users training. Indeed, considering the existing traffic congestion, the Part-Dieu user has to be informed on the way to use the station. A system of signage and virtual corridors can guide the passenger to improve intermodal transfer time without troubling other users. The presence of "red jackets" personnel inside the station can also help first to regulate the traffic flow but also to inform and advice unusual passengers.

The third lesson focuses on the life in station. It not only refers to the Part-Dieu station but more generally to a new tend observed in French station. In parallel of transport activity, the station

become more and more a daily activity center. More than traditional shops (with bars, kiosks, ...) and facilities (waiting rooms, counters to buy tickets), the intermodal station wants to become a real activity center. For exemple, non-daily shops like perfume or clothes shops are implemented in stations as well as top-end bakers or ice-cream makers. The coming of these new stores reflect the ambition of terminal manager, Gares & Connexions, to change the transport station into a "comfortable place with a pleasant audio environment, temperature and lighting atmosphere". The station is no more a transport place devoted to urban and rail passengers but a central place in the city to welcome passengers, locals, passers-by and tourists. Working spaces and business centres are planned to be implemented. Stations are now opened to partners to buy an advertising space, to organize an event or to ... shoot a film! In this opening context, stations forum have been implemented in 2010. As mentioned by Gares & Connexions, they draw together experts, professionals working in station design and operation, politicians, journalists and customers to discuss and design the stations of the future. Among the topics proposed in previous sessions we can note: "space of connections", "public areas with a new lease of life" or "microcosms of a post-industrial society".

These forums symbolize that historical stations stakeholders, i-e transport operators and transport users, are play a leading role but are not alone! The space of the station is now appropriated by various stakeholders not directly involved in transportation context.

Facing this new trend, we can ask the reasons of such an opening to the "real world". Two main explanations can be analysed. The first one refers to the financial challenge. In a context of real estate prices increase, terminal managers have to make their station profitable. They have to maximise the station layout to satisfy the user, to attract more transport operators and external partners (retailers, businessmen, civil services...). Higher will be facilities and comfort, higher tariffs for rail operators will be. The second explanation is links to the "new" competition in the rail sector. Gares & Connexions, the terminal manager organization is a SNCF business unit created in 2009 following the French government demand. This unit has to manage, develop, and to invest on the 3000 French rail stations. It has been created in the liberalization on the railway sector context where transport activity needs to be separated to the station management. A strict account separation between SNCF and its unit Gares & Connexions has to be observed to prevent a competition distortion.

As a conclusion, the Part-Dieu station is at the heart of some important intermodal "nodes" and offers an interesting illustration of an intermodal station. In spite of the different interconnectivity barriers highlighted in this report, it should be noted that the station is not neglected by terminal managers or local governments. It is one of the main aspect of the "Lyon

rail node” and is at a crossroad of urban, regional, national and international lines and transit corridors.

6.6 Faro International Airport, Portugal

The airport of Faro is the main gateway for accessing the touristic region of Algarve, in the south of Portugal. The airport is located 5 km away from the main city in the region: Faro.

The airport was built between 1962 to 1965, and it has already undergone through two major upgrade interventions, the first in 2001 and the second started 2009 and it is expected to finish by 2012. The airport is composed by one building and one runway, with 2500 meters.

Currently, the traffic is concentrated in a few Low Cost Companies. The passengers are essentially European and the main reason for travelling is for leisure purposes.

6.6.1 Main features of the site

In the last decade an increase in the flow of passengers at the airport of Faro is recorded (Figure 6.251). The airport has capacity for 6 million passengers per year and in 2007 it has reached the mark of 5.47 million passengers. The current works will increase the maximum capacity from 6 to 8 million passengers per year [ANA, 2008].

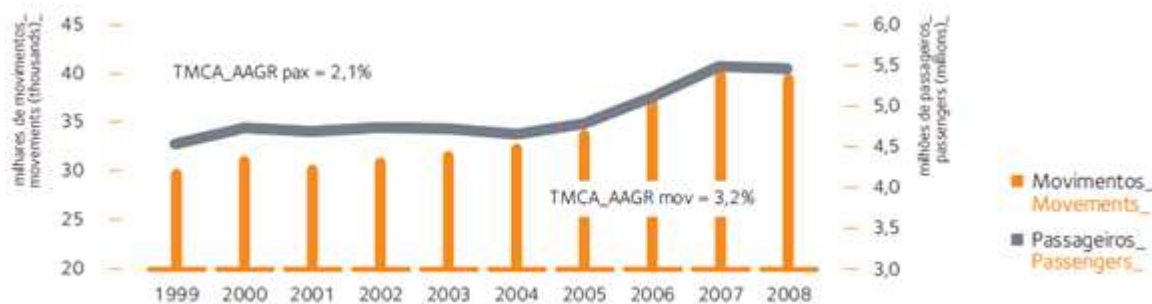


Figure 6.251 Annual development of commercial passengers and movements (ANA, 2008)

Owing to the touristic nature of the region, charter companies traditionally dominated the passenger traffic. Over the last couple of decades, the Low Cost Companies have eventually overthrown them and currently dominate almost 90% of the schedule segment. The increase of the scheduled segment was reflected in a variation from the 68% recorded in 2007, to 73% in 2008, in the overall structure of passenger traffic by the type of operation (Figure 6.252). This increase in the share of the scheduled segment was a gain by the low cost operation at the expense of the charter segment [ANA, 2008].

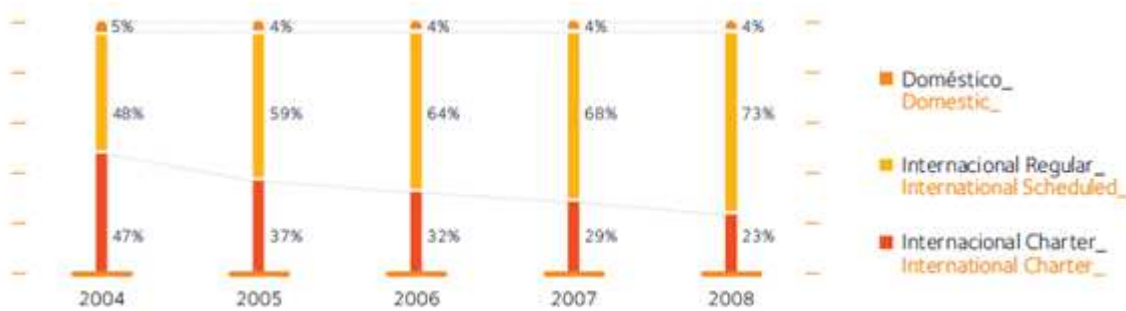


Figure 6.252 Development of the Passengers Traffic Structure (ANA, 2008)

The airport of Faro presents a high seasonality since it fundamentally serves the tourist activity of Algarve region which attraction lies in natural conditions such as sun and sea during the summer. Therefore, there is a structural imbalance between the IATA Summer and Winter demand. Figure 6.253 shows the irregular month traffic throughout the year.



Figure 6.253 Commercial Traffic Processed per Month (ANA, 2008)

Figure 6.254 shows passengers growth in the main market. The United Kingdom is the main market for the airport and its position is consolidating over time. German market traffic, both direct and indirect (via Palma de Mallorca, Spain) maintained the trend of a slow drop over the last years. In light of the foregoing, the main reason for the strong decline registered by the Spanish market in 2008 is explained by the closing of the Ryanair routes to Madrid and Barcelona. Ireland represents a market that had recorded important growth in the previous years. Nevertheless, also saw a reduction in the demand for although it continued to register notable growth in the last years. Domestic traffic consists essentially of connections via Lisbon

Airport and remained at the same level as the previous year, representing 3.6% of the volume of passengers handled in 2008 [ANA, 2008].

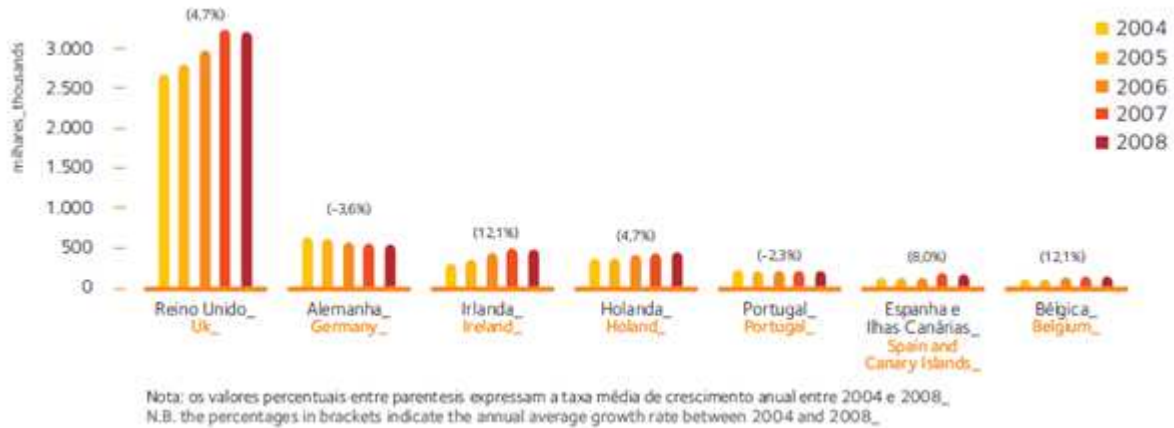


Figure 6.254 Passengers Growth in the Main Markets

Regarding air connections, the airport of Faro can be classified as a regional airport, since the large majority of the connections are to European destination. Only one intercontinental route is available to Toronto. The country with higher connections and flights is the United Kingdom, reflecting its importance.

The airport has a surface area of 237 ha, is composed by one building and one runway, with 2500 meters. There are 60 check-in desks, 22 stands of which 16 are remote, and 36 boarding gates. As for parking capacity, there are 1400 available parking spots.

Regarding the services available at the site, the airport provides a variety of opportunities such as luggage trolleys and luggage lockers, restaurants and cafeterias, tax free shops, car hire stands, internet facilities, etc. New commercial spaces will be constructed until 2013. Information systems are also available for passengers in the form of display screens with information regarding the arrivals and departures. An information system has also been implemented to assist the landing process by computer, the ILS – Instrument Landing System.

6.6.1.1 Identification of the site

6.6.1.1.1 Geographical coverage and transport modes

Only road based connections are offered at the airport. The nearest train station is located in the city centre of Faro. The available transport services are: public bus, private bus (shuttle), taxi, rented-cars, or private cars.

In terms of **public bus**, there is one transport operator serving the airport: EVA – Transportes. This operator links the airport with the main bus terminal in the city centre. From this terminal

there is a large variety of routes to the main cities of Algarve region and to the main cities in Portugal. Bus terminal is located near the train station of Faro, which offers the possibilities of regional and a long distance lines. The offered bus service between airport and the city centre starts at 5 a.m. and ends at 11 p.m. more or less during the summer, with a frequency of 20 buses per day, and presents a maximum waiting time of 1H25. Travel time between the airport and city centre is 20 minutes and the cost of this trip is 1.75€. Once passengers arrive at bus station city centre it is possible to get a rapid bus for several touristic places in Algarve.

In Figure 6.255 it is possible to see more information about the bus connections between Faro city center (not from airport) and other cities in Algarve region.

City	Trip Cost	Travel Time	Frequency per day	Maximum Waiting Time
Albufeira	4.40 €	55 min	7 buses	3H25
Portimão	5.15€	100 min	7 buses	3H25
Vilamoura	3.75€	40 min	24 buses	1H15
Tavira	3.95€	60 min	11 buses	2H00
Lagos	5.55€	130 min	6 buses	3H25

Figure 6.255 Some Bus connections from Faro city center (Source: EVA – Transportes website)

Private bus (shuttle) services are also available at the airport. These services can either be booked on-line directly to the transport providers, or as a transfer service in a hotel package. The private bus operators cannot directly sell tickets to the passengers at the airport.

City	Trip Cost	Travel Time	Length
Albufeira	55.00 €	45 min	45 km
Portimão	75.00 €	60 min	70 km
Vilamoura	45.00 €	35 min	25 km
Tavira	50.00 €	40 min	40 min
Lagos	85.00 €	75 min	90 km

Figure 6.256 Some private shuttle connections costs

There is a wide and permanent offer of **taxi services**. Besides normal taxi services there is a special taxi for tourist passengers that is more expensive. Taxis are one of the most common options to leave Faro Airport. We contacted ANTRAL, which is taxis' national association, in order to have an estimation of trips costs on taxi from Faro Airport. Figure 6.257 shows the obtained results.

City	Trip Cost	Travel Time	Length
Albufeira	45.00 €	40 min	45 km
Portimão	80.00 €	55 min	70 km
Vilamoura	35.00 €	30 min	25 km
Tavira	60.00 €	35 min	40 min
Lagos	100.00 €	65 min	90 km

Figure 6.257 Some Taxi connections from Faro Airport (Source: ANTRAL)

Passengers can also **rent a car** at the airport. There are eight different rent-a-car companies operating at the airport that works daily between 7 a.m. and midnight. From the airport, there is a four-lane access road that connects to the main national road on the region (N125), which connects to the region highway and with direct access to the south of Spain (A22) and to the highway to Lisbon (A2).

Another possibility to get to airport is using **own car**. The airport presents five distinct parking packages with very different prices, being:

- Premium – maximum comfort and departures direct access;
- Executive – high comfort and departures direct access;
- Classic – standard comfort and free shuttle;
- Low Cost Plus – cheap quality and free shuttle;
- Low Cost – best price and free shuttle.

6.6.2 Method for data collection

The following methods have been used to collect data for this case study:

- Interviews with local stakeholders (airport of Faro, taxi representatives, bus company, etc.);
- Stated preferences survey (1000 interviews);
- Local observation;
- Previous studies and surveys.

6.6.3 Stakeholders/Agents at the site

The main stakeholders, accordingly with HERMES four categories (Deliverable 3), are:

- **Public decision makers:**

- Municipality of Faro: the airport is located within the jurisdiction of the Municipality of Faro. Consequently, all land based
- National Civil Aviation Institute (INAC): this entity is the national civil aviation regulator;
- Ministry of Agriculture, Sea, Environment and Territory: the airport is located within a natural protected region (EU Natura Network). Therefore, any expansion and air traffic activity is subjected to approval from the ministry.

- **Terminal managers:**

- ANA – Airports of Portugal: ANA is the entity responsible for managing the airport. All contracts with airline companies operating at the airport are ANA responsibility.
- Car parking manager (Emparque): Emparque is the entity that manages the airport parking lots, has a contract with ANA that establishes operating terms.

- **Transport operators:**

- Transport companies (airlines, public transport, taxi and rent-a-car).

- **User association:**

- DECO (Portuguese consumers' protection association): DECO, consumers association, does not usually interact with ANA but if any passengers complain is presented the association contact ANA in order to defend passengers' rights whenever it is necessary.

The agents with relevancy for the definition of the business models are:

- Passengers;
- Airport of Faro (ANA);
- Rent-a-Car companies;
- Taxis;
- Public Transport;
- Private Shuttle Companies;
- Hotels.

6.6.3.1 Objectives and Goals

The objectives and goals of each agent are as follows:

- **Passengers:** although we may classify the passengers in different clusters accordingly to with diverse attributes variables (such as: purpose of the travel, with whom are they travelling, who

has booked the trip, how often do they travel, etc), ultimately all of them share a common goal: to reach the final destination safely, with reasonably low travel time, and minimising transport costs and travel time. What changes among them is the willingness to pay for getting different services, and how do they perceive the quality of the service. The characterisation of the passengers at the airport of Faro is presented further on the report.

- **Airport Manager and land Transport providers** (rent-a-car companies, taxis and public transport, private shuttle companies): ultimately, these agents seek to increase the profits. In this case study, and for simplification purposes, we assume that this may be achieved through an increase in the throughput of passengers.
- **Hotels:** improving the customer’s accessibility, by providing alternative transport solutions (private shuttle) without fixed costs (provided by other entity), high quality level and costs similar to the current one.

6.6.3.2 Strategies

The strategies of each agent to attain the above mentioned objectives are now presented:

- **Passengers:** to plan the journey in advance.
- **Transport companies:** in overall, to improve the amount of available information, in particular, each agent can also adopt some of the following strategies:
 - Taxis: to improve the route planning, to improve language skills, to provide touristic information on-board;
 - Public transport: to adapt the bus schedule with the flights’ arrivals (actual arrivals, not those on the timetable, to provide touristic information on-board, possibly selling tickets on-board for some attractions.
- **Airport Manager:** to improve the available information; to foster and promote integration between transport providers; to improve the physical conditions of the terminal.

6.6.3.3 Interactions between agents

The following matrix presents the interactions between each pair of agents. The interactions have been classified as follows:

- Service Provider: when there is a client – provider relationship between the pair of agents;
- Competition: when the two agents compete against each other;
- Cooperation: when the pair of agents cooperate to improve the quality of the service to the passengers.

In Figure 6.258 below we present a description of the interactions between each pair of agents.

<i>Agents</i>	<i>Passengers</i>	<i>Airport Manager</i>	<i>Rent-a-Car</i>	<i>Taxis</i>	<i>Public Bus</i>	<i>Hotels</i>	<i>Private Shuttle</i>
<i>Passengers</i>		Service Provider	Service Provider	Service Provider	Service Provide	Service Provider	Service Provider
<i>Airport Manager</i>			Service Provider / Cooperation	Cooperation	Cooperation	Cooperation	-
<i>Rent-a-Car</i>				Competition	Competition	-	-

<i>Taxis</i>					Competition	Cooperation	-
<i>Public Bus</i>						-	-
<i>Hotels</i>							Service Provider
<i>Private Shuttle</i>							

Figure 6.258 Interactions between each pair of agents

6.6.3.4 Graphical representation

Based on the concept of agents and on the web of interactions between the various agents, the following figure represents the current business model at Faro Airport according to Agent Based Model representation (Figure 6.259).

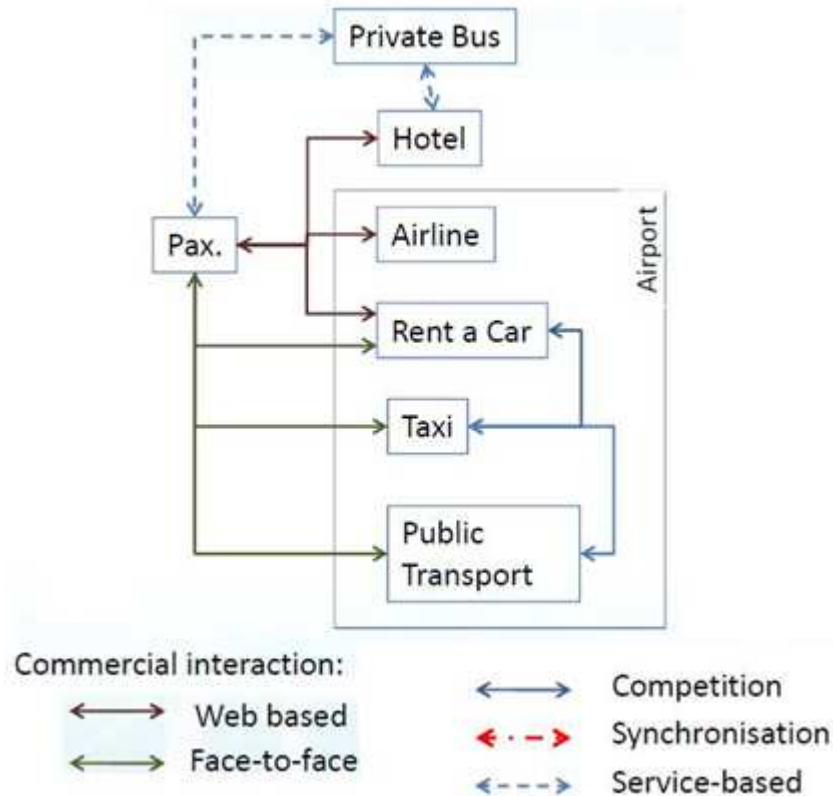


Figure 6.259 Agent Based Model Graphical representation of current Business Model

6.6.4 Current short-long interconnectivity problems/opportunities

There are several problems affecting the interconnectivity at the Airport of Faro. These problems are visible at the various levels of decision. At **strategic level**, we could identify a lack of strategic alignment between stakeholders. Indeed, intermodal transport is not a priority for any of the stakeholders. They are only interested in providing their own transport service, and essentially consider all the others as competitors, in particular, in the land based transport providers. In what concerns the air transport providers, and in particular the low cost companies, they traditionally do not establish agreements with road based transport providers.

At **tactical** and **operational levels**, we could identify the following barriers, such as:

- **Information** - there is no available aggregated information concerning the several transport solutions. Each mode of transport only offers information about its own services;
- **Ticketing** - there is no integrated fare system. The passenger needs to buy a ticket for each leg;
- **Scheduling** - there is no integration of schedules. This problem is somewhat reduced since the majority of the passenger use flexible land based transport services, such as: taxi, rented cars or private shuttle.

6.6.5 Current value proposition

An intermodal transport scheme normally involves several transport companies and other stakeholders. Each one follows a specific business model. Recalling the definition used in the HERMES project, we may conclude that a business model is related with a given company (occasionally a group of companies which may be linked through some kind of consortium agreement). As such, in an intermodal transport services, we may identify several business models. Yet, if we seek to design a single business model then we must define from which stakeholder's perspective the business model is designed. In the present case study, we adopted the perspective of the airport manager: ANA – Aeroportos de Portugal, as they are the only partner who would be present in all intermodal transport schemes at the airport.

Further reasons underlying this choice are the following. Passengers are the agents most affected by the current lack of intermodality. The barriers are essentially perceived upon arrival to the airport (and to some extent in an earlier moment during the planning of the trip). Indeed, passengers build their perception on the transport providers after buying the ticket and starting the journey. The airport is thus being negatively affected by the lack of intermodality, which is evidenced in the growing amount of negative reviews and references posted by the passengers on some major international travel websites. Ultimately, such negative image may lead passengers to choose another destination. This potential threat is being taken seriously by the airport managers, as emphasised in the meetings held during the project. Also, there is a tense relationship between the various land based transport providers. They see each other as competitors and consequently are not willing to engage in any sort of cooperation. Conversely, there is no such tense relationship with the transport providers (although the relationship is not free of problems). Therefore, the airport is in a key position to perform the role of facilitator and negotiator, between all transport providers. Finally, the airport plays a key role in the economical development of the region. It has therefore some degree of influence in many other

agents, such as: municipalities, hotels and similar, which can be fundamental for the viability of the proposed business model.

Looking again for the current transport services provided to and from the airport of Faro, we may conclude that, in practical terms, no intermodal transport services are offered at the airport of Faro. Instead, there is a set of independent services connected at the same location - the airport. The passenger has to build his multimodal transport service, which is nothing more than a collection of individual transport legs.

Recalling, that we are defining the business model (and the value proposition) from the perspective of the airport, we may conclude that intermodal transport is not included in the current value proposition of the airport.

6.6.6 Description of current business model

According to Osterwalder (2004) there are nine building blocks Customer Segments (CS), Value Propositions (VP), Channels (CH), Customer Relationships (CR), Revenue Streams (R\$), Key Resources (KR), Key Activities (KA), Key Partnerships (KP) and Cost Structure (C\$).

ANA – Aeroportos de Portugal, entity that manages Faro Airport, has conducted several surveys over the last years in order to understand customer profile based on passengers profile and travel characterization. Surveys information was a courtesy of ANA to our case study.

6.6.6.1 Value Proposition (VP)

The current value proposition is explained in previous chapter. The business model is defined from the perspective of the airport manager. In this sense, we may say that intermodal transport is not included in the current value proposition of the airport.

6.6.6.2 Customer Segments (CS)

Faro Airport presented during 2009 about 5.3 million passengers. According to the airport website, during an IATA summer, arrivals can easily reach 64 flights per day.

Figure 6.260 shows travel purpose percentages. Tourism represents the strong trip motive to Faro Airport since it represents 82% of the total. This observation was expected since Algarve is mainly a touristic destination.

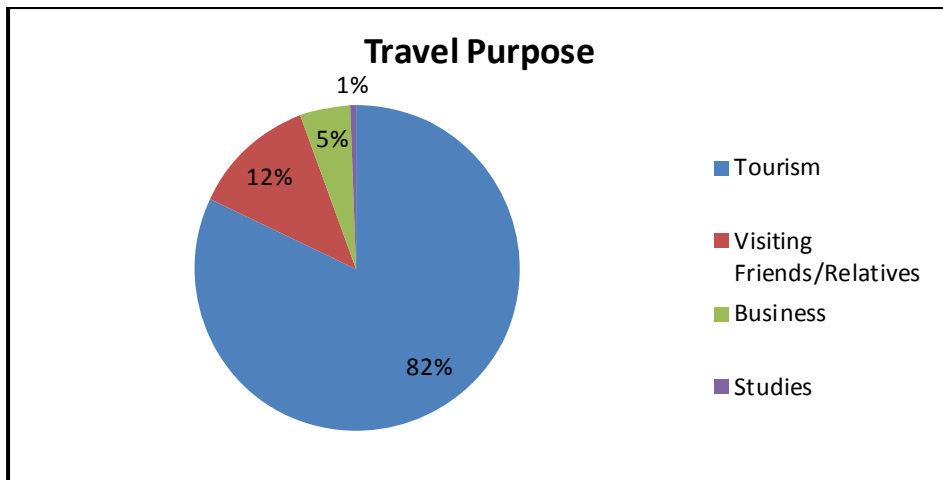


Figure 6.260 Passengers' Travel Purpose (Source: ANA Survey, 2010)

More than half of the interviewed passengers travel with their family. Family trips require more complex transport logistics comparing with travelling alone. Figure 6.261 shows passengers accompanying percentages.

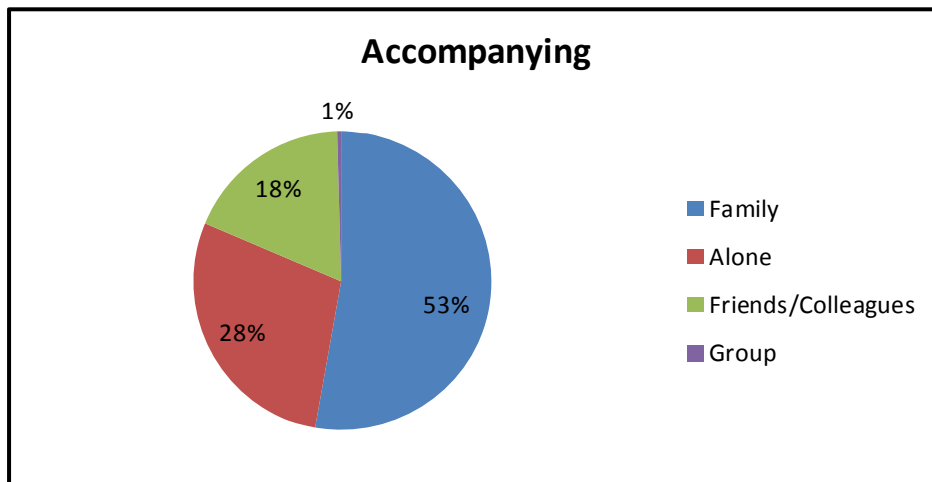


Figure 6.261 Passengers' accompanying members (Source: ANA Survey, 2010)

Figure 6.262 shows the current percentages of land transport mode choice to leave the airport. We can observe that rental car and private bus (provided by hotels) represent the main choices.

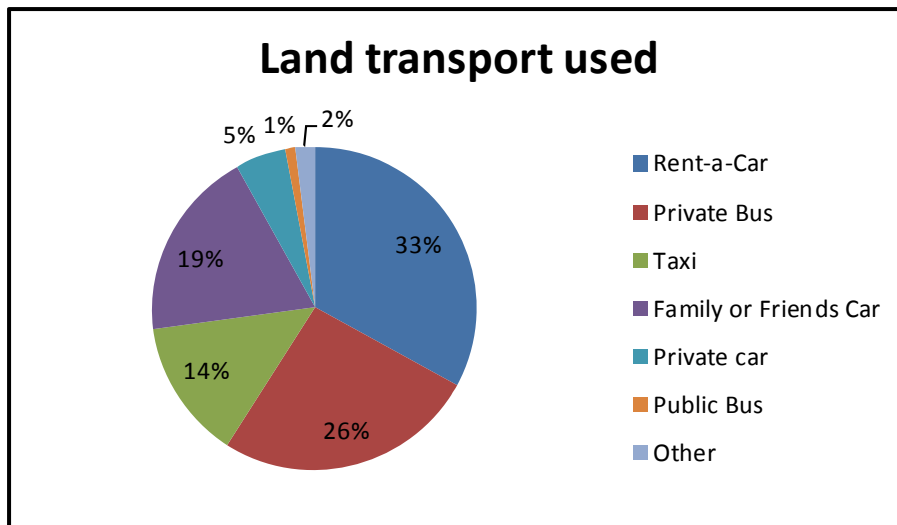


Figure 6.262 Land transport used to arrive at the airport (Source: ANA Survey, 2007)

The most common destination cities in Algarve are: Albufeira, Portimão, Vilamoura, Tavira and Lagos. Figure 6.263 shows the percentage distribution according to ANA 2010 survey.

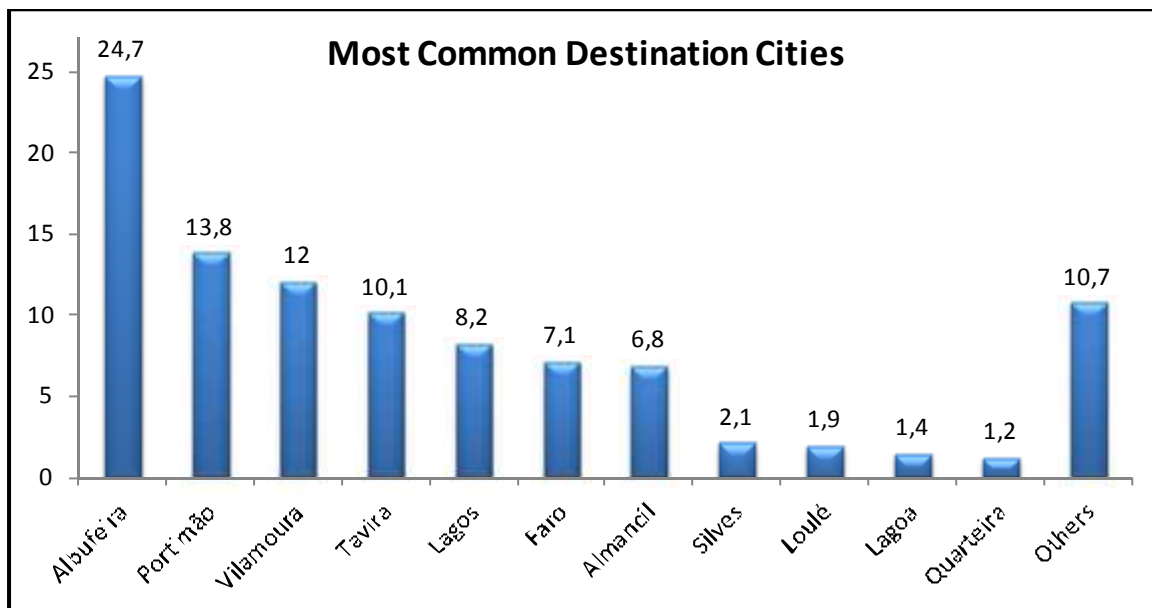


Figure 6.263 Passengers most common destination cities (Source: ANA Survey, 2010)

6.6.6.3 Channels (CH)

Stakeholders use multiple channels to communicate with their passengers, but all of them are proprietary (and transport provider based). This means that passengers need to use several channels to get information on (and eventually buy the tickets from) the diverse transport providers.

The following channels are available:

- Internet communications:
 - The airport's website has information about the transport modes that can be used to how passengers can leave the airport.
 - Information about taxi services is only available through the national association of taxis (ANTRAL). However, the usefulness of the website is somewhat limited as it is only available in Portuguese. Reservations through Internet are not possible.
 - The website of the public transport operator provides general information on fares, schedules and destinations. Reservations through Internet are not possible.
 - All rent a car companies have a website. Most of them allow reservation and payment via internet.
 - Private bus companies only sell through internet, so all of them have well developed websites.
- Face to face communications:
 - Taxis are available at airport entrance and passengers can collect information with taxi drivers at the site.
 - Rent-a-car companies have proper desks at the airport to inform passengers about their services.
 - Public bus drivers are responsible for selling tickets and passengers can also find more information about this service with them.
- Telephone based communications
 - Through telephone it is possible to check with ANTRAL the travel cost on taxi, since prices are different according to day time or week day.
 - Rent-a-car companies also provide their phone number so passengers can collect information also make a reservation by phone.
 - EVA, public bus company, is also possible to reach by phone to get information but is not possible to make reservations through this channel.

6.6.6.4 Customer Relationships (CR)

We did not identify strong relationships between stakeholders and their customers besides the actual delivery of the service. Most stakeholders do have any kind of relationship, this includes: taxis, private bus, public bus and some air transport companies. Those who have invested in building some sort of relationship with their customers, use the typical fidelity programs or offer cheaper bundle services, these include:

- Rent-a-car companies that have fidelity programs which are advantageous for regular customers.
- Hotels that also use their fidelity programs coupled with service packs (including accommodation and transfer) with some discount.

6.6.6.5 Revenue Streams (R\$)

The main revenue streams for the Airport Company are fees paid by airlines to operate at Faro Airport, but parking revenues, and rental of commercial spaces represent important additional revenue streams. Some of the stakeholders resort to other sources of revenues, such as advertisement on taxis or buses for example, or provision of added valued services.

6.6.6.6 Key Resources (KR)

Each stakeholder has its own set of key resources depending on its business and positioning in the transport chain. In general terms the resources can be divided into the following types:

- Vehicles
- Infrastructure
 - Physical infrastructure (includes: airport terminal, parking lots, parking stands, front desks, etc)
 - Technological infrastructure (includes: websites, communication systems, etc)
- Human Resources

6.6.6.7 Key Activities (KA)

The key activities are related with the provision of transport services. Like the previous building block, the activities are function of the stakeholder's positioning in the transport chain. In general terms these can be divided in the following ones:

- **Customer oriented activities:**
 - **Information and Marketing** – activities related with the promotion and advertisement of the transport services, communication with the passengers and selling of tickets;
 - **Transferring** - activities, services and amenities aiming to provide a comfortable experience to the passengers while at the airport (including: resting areas, food courts, shops, etc).
 - **Transport service** – activities related with the transport of the passengers from and to the airport;
 - **Parking** - activities that allow the passengers to transfer between two modes of transport, or that provide temporary storage for the private vehicles;
- **Stakeholder (or internal) oriented activities:**
 - **Financing and Economics** - activities related with the assessment of costs, revenues, financing and similar activities.
 - **Planning and Management of Operations** – activities related with the planning of the transport services (in terms of scheduling, paths, costs, etc) and related with the implementation on daily services.

6.6.6.8 Key Partnerships (KP)

Few partnerships have been identified at the site. The airport manager has good relationships with some of the stakeholders, but few of them are few formal partnerships. There are partnerships established with some of the low cost companies to establish routes. There is another partnership with the company Emparque for the concession of the parking lots. Recently, on an informal basis, the public transport provider agreed to extend its daily service to embrace the airport functioning timing.

6.6.6.9 Cost Structure (C\$)

The cost structure is specific of each stakeholder. Yet, the main items of the cost structure include:

- Human resources;
- Vehicle and fleet (acquisition, rental and maintenance);
- Infrastructure (planning, building and maintenance);
- Fuel;
- Debt, amortization and other.

6.6.7 Current level of quality of services and customer satisfaction

In order to understand ANA's perspective about transport modes services at Faro Airport we had two meetings: one with the previous Faro Airport Marketing Manager, Mr. Francisco Pita, and another one with Faro Airport Manager, Mr. António Mendes. The summary and main conclusions of these meetings are below.

On the 7th of June of 2011 we had a meeting with Mr. Francisco Pita, previous Marketing Manager of Faro Airport. Currently, Mr. Francisco Pita is the Deputy Airport Manager at Lisbon Airport but until May 2011 he was the Marketing Manager at Faro Airport.

Mr. Pita stated that the main problem about Faro Airport is the seasonality character, although nowadays are lower. He also noted that tourist centers in Algarve are scattered, a conceptual problem that interferes with transport planning. Nevertheless, transport legal and regulatory aspects regarding interurban transport are being a barrier to new transport services at the site.

Passengers from United Kingdom usually prefer to leave airport by taxi since in Portugal cars circulate on the opposite side that they are used to drive. Taxi prices and fares are not always clear and passengers usually complain about it. For example, Mr. Pita told us that a family with four members commonly have to use two taxis since trunks size are not enough to support four bags.

Mr. Pita also referred that public bus are not a common option since passengers usually travel with children and luggage that is uncomfortable to carry on public bus. Since public bus only drives passengers to Faro, is necessary to cross Faro terminal and find another bus to final destination. Faro terminal are not well equipped for trolleys circulation and information are not enough in his opinion.

We presented our proposal to improve Faro Airport interconnectivity which is based on a regular shuttle that leaves passengers at their final destinations with three stops maximum. Mr. Pita found the proposal interesting but warned us that taxi drivers should be somehow involved. This warning is based on a previous experience of a regular bus to Spain that taxi drivers vandalized since they felt threat by this service.

It was Mr. Pita understanding that besides taxi drivers, all stakeholders should be interesting in this new service. Hotels should be very interested since customers will better serve and they do not need to have a private bus anymore. ANA is also interested since passengers' satisfaction promotes airport image and utilization.

On the 15th of July of 2011 we had a meeting with Faro Airport Manager, Mr. António Mendes. This meeting has the objective of understand Mr. Mendes opinion about our proposal to improve interconnectivity in Faro Airport.

Mr. Mendes analysed our results and made a few suggestions regarding some operations aspects according to his experience.

6.6.7.1 Survey Results

Between 3rd and 11th of September of 2011 we conducted a stated preferences survey at Faro Airport. We collected 1012 valid answers at departure gates and luggage corridors. Only taxi, private bus and public bus customers were interviewed since they are our target market.

Survey had in the beginning a social-demographic characterization of passengers, questions regarding their satisfaction with the current transport modes supply, price and waiting time. We also made a few questions regarding the new service, for example, if they were interested on an integrated ticket or even to buy on plane a shuttle ticket to their final destination. Some of the data collected are present below.

6.6.7.1.1 Passengers general characterization

On Figure 6.264 is possible to observe that 48% of passengers' age is between 26 and 45 years old. If we ignore passengers under 26 years old, age distribution is balanced in the remaining four groups.

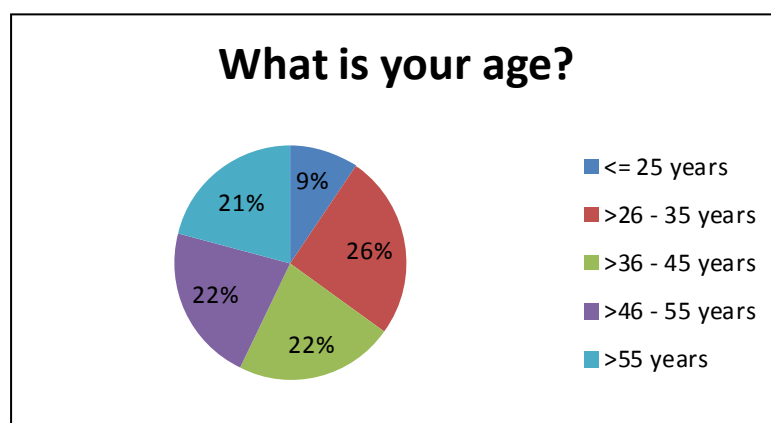


Figure 6.264 Passengers' age

As we can see on Figure 6.265, 66% of passengers organized their own trip. This means that most passengers are independent from agencies and if we want to sell a new transport service is not enough to advertise only on travel agencies.

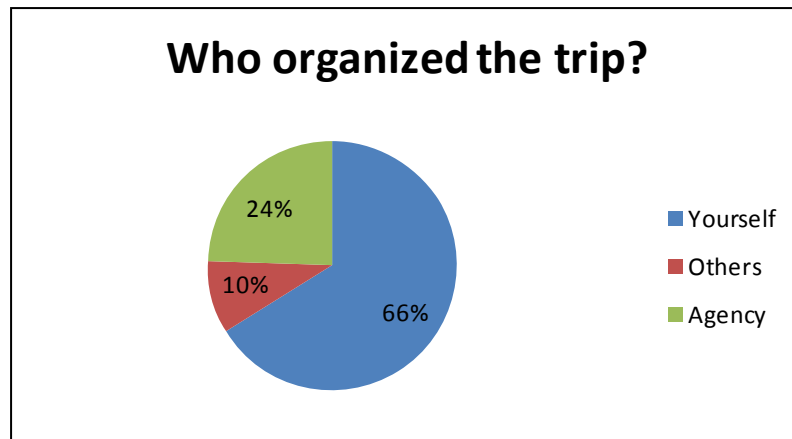


Figure 6.265 Who organized the trip

The channel that 84% of passengers used to organize the trip is Internet, as Figure 6.266 How passengers' organized the trip **Error! Reference source not found.** shows. This result is consistent with the finding on Figure 6.266: since most passengers organize their own trip is expected that Internet is the most common channel to do it.

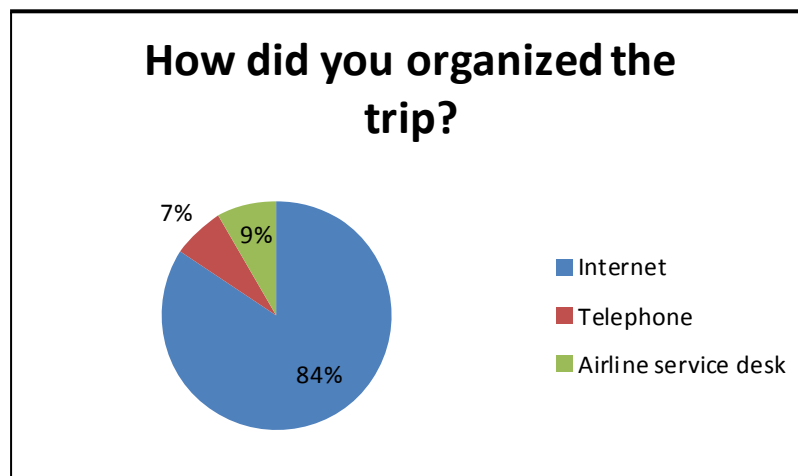


Figure 6.266 How passengers' organized the trip

On Figure 6.267 is possible to observe that almost 75% of the interviewed are travelling with family. Travelling with family currently means children and extra luggage and these are the groups that usually complain on taxi drivers since a taxi is not enough to transport four members of a family and their luggage, so families have to slip themselves and use two taxis.

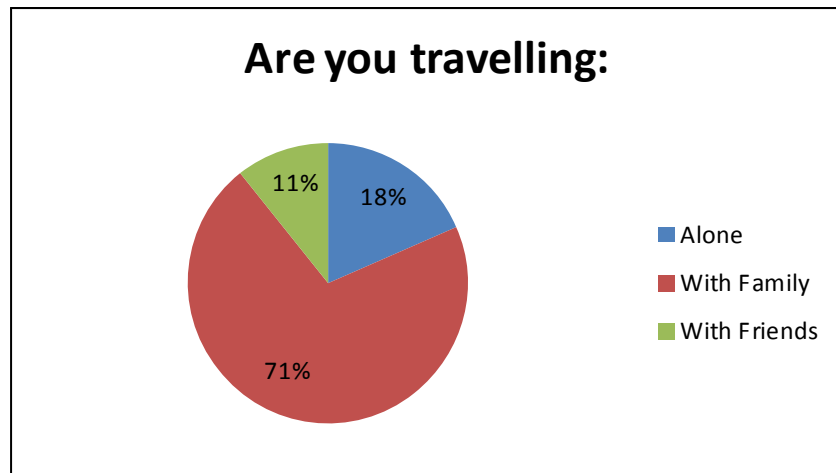


Figure 6.267 Passengers' accompanying

Only taxi, private bus and public bus customers were interviewed since they are our target market. Figure 6.268 shows passengers distribution over these three transport modes. We can see that more than 50% of passengers use private bus to reach or leave the airport. Private buses are provided by hotels and represent fixed costs with vehicles and legal procedures. Here is an opportunity to involve this stakeholder on the proposed shuttle service for Faro Airport.

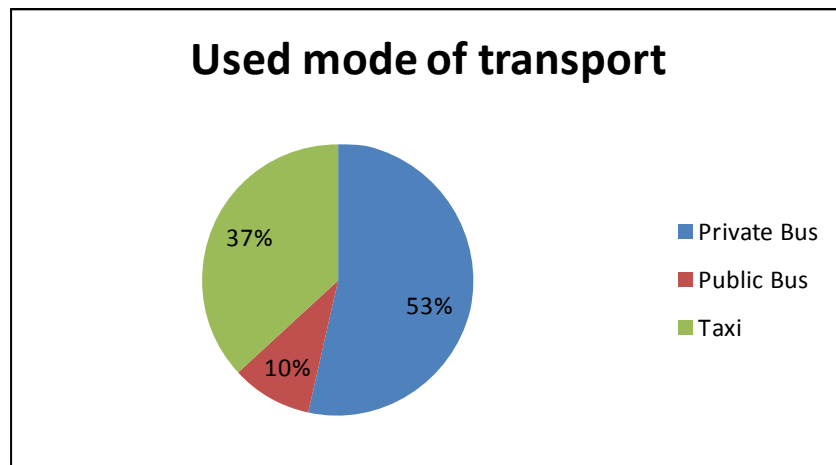


Figure 6.268 Used mode of transport to leave or reach the Airport

Figure 6.269 shows that 85% of the interviewed trip motivation is vacation. Since Algarve is the most touristic region in Portugal this result was already expected. Passengers on vacations travel with their family which requires transport conditions for luggage and children that taxis are not able to provide since available space on vehicles are not enough.

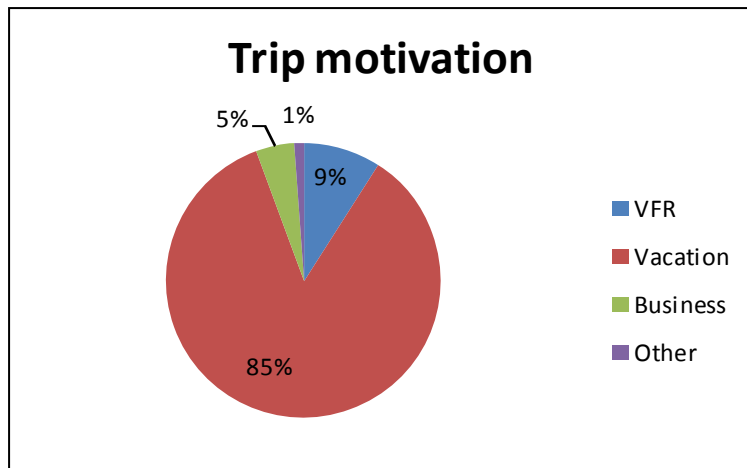


Figure 6.269 Passengers trip motivation

6.6.7.1.2 Passengers level of satisfaction

We made a few questions regarding passengers' level of satisfaction on different aspects, for example, waiting time at the terminal, transport cost, terminal conditions, and supply of transport modes among others.

As we can see on Figure 6.270, 44% of passengers are not satisfied about travel time. Nevertheless, 53% are satisfied and it is likely that they represent taxi customers since this transport mode does not present significant waiting times.

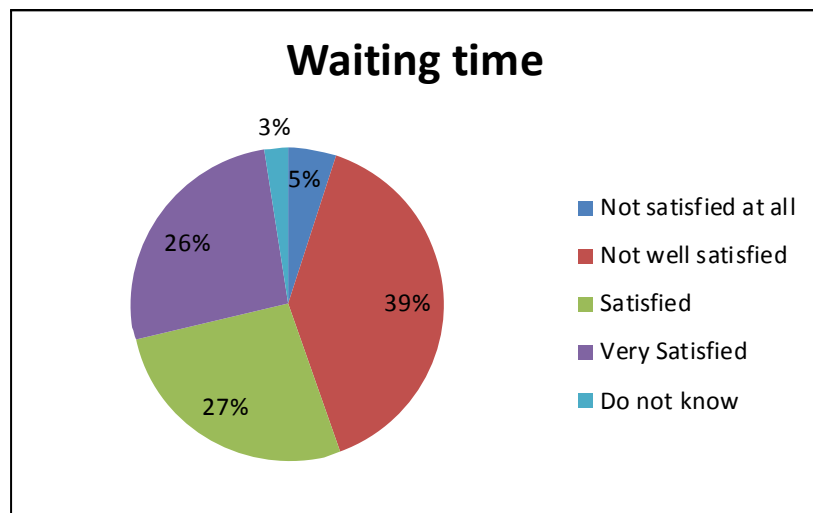


Figure 6.270 Satisfaction level regarding waiting time

Figure 6.271 shows that 49% of passengers are satisfied with transport costs. These passengers should be users of private bus. Taxi customers should be part of the 47% of passengers that are

not satisfied with transport costs since according to ANA, passengers usually complain on taxi unclear fares.

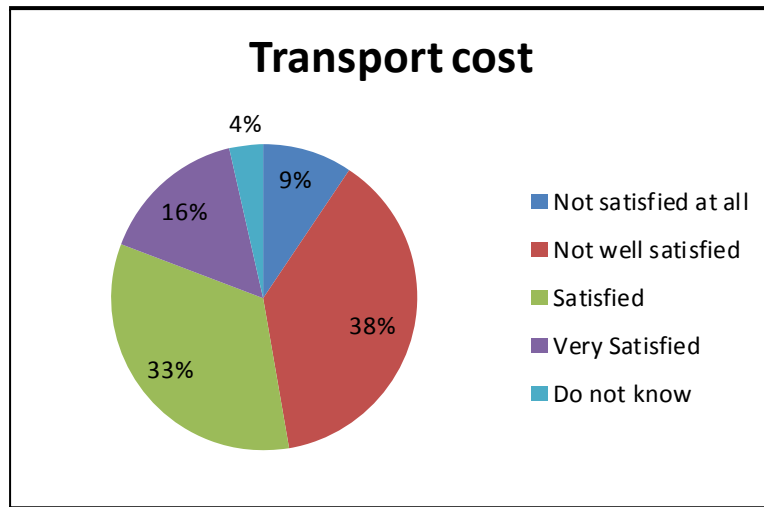


Figure 6.271 Satisfaction level regarding transport costs

46% of interviewed passengers are satisfied with the conditions at the terminal to take a taxi, private bus or public bus. 11% of the interviewed are even very satisfied as we can see on Figure 6.272. Since taxis stop is located at airport door, unsatisfied passengers are the ones that use private or public bus, specially the last ones who walk the longest distance to reach the stop.

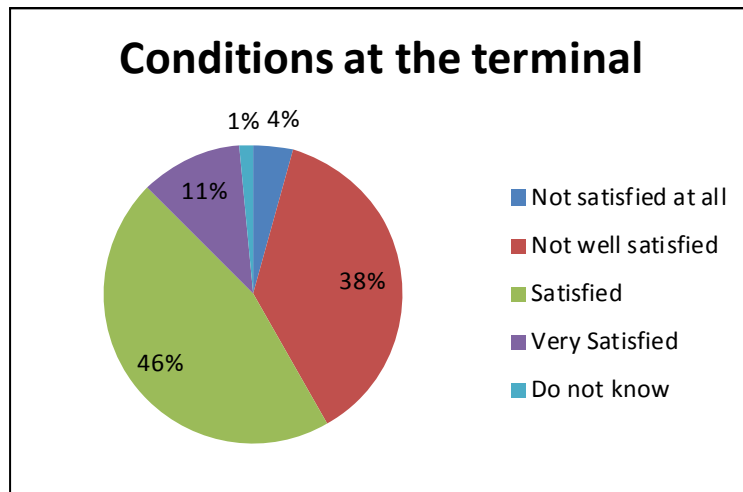


Figure 6.272 Satisfaction level regarding terminal conditions

Figure 6.273 shows that 46% of passengers are not satisfied with transport modes supply at Faro Airport. This result was already expected since supply is only based on taxi with unclear fares, public bus to Faro city centre with non-coordinated schedules and private bus to hotels.

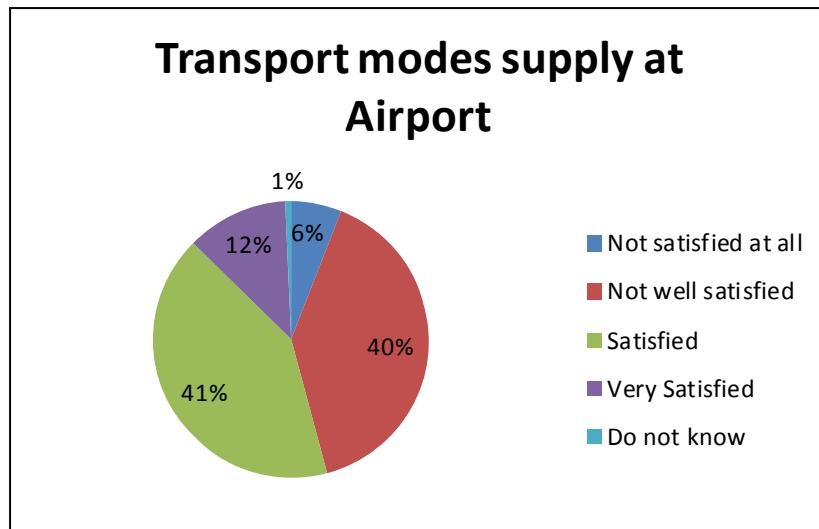


Figure 6.273 Satisfaction level regarding transport modes supply

Figure 6.274 results indicate that half of the interviewed are satisfied with travel time to reach their final destination, and the other half not. Since 85% of the interviewed are on vacations, it is expected that people are willing to spend more time on travelling.

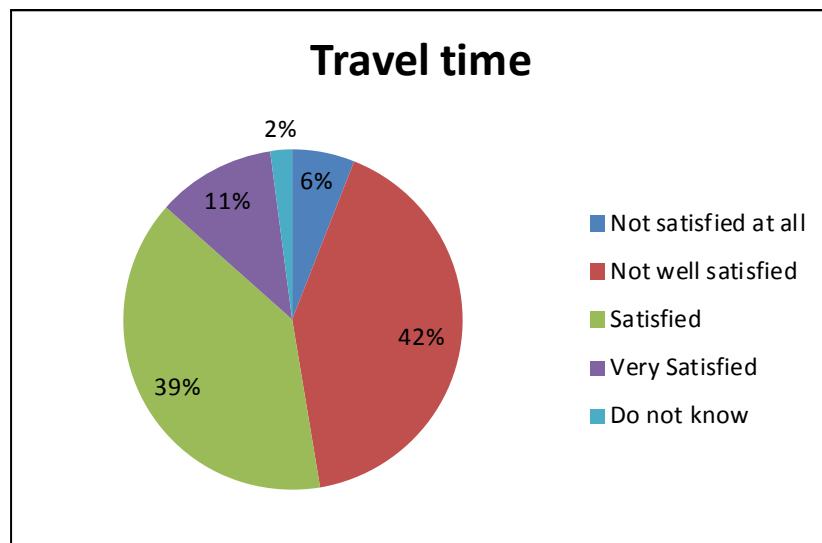


Figure 6.274 Satisfaction level regarding travel time

6.6.8 Analysis for improvement of interconnectivity

6.6.8.1 Validation of findings in WP3/WP4

Work Package 3 and Work Package 4 categorised the barriers and challenges to the development of intermodal transport services. Work Package 3 analysed the regulatory and legal related barriers, whereas Work Package 4 analysed the technological related barriers. We now describe the barriers at the airport of Faro according to the taxonomy presented in these Work Packages.

Work Package 3 identified a total of 6 types of barriers, being:

- Legal/regulatory
 - Portuguese legal framework imposes significant barriers to the operations of scheduled public transport services, leading transport operators to find 'creative' solutions to overcome it. The most common alternative is the introduction of non-scheduled public transport services, running as a scheduled one;
 - Lack of a legal framework on intermodal transport (it is modal-based).
- Institutional
 - There is no public authority responsible for the management and coordination of public transport services at regional level;
 - There is no institution to promote and facilitate the interaction, dialogue and coordination among transport providers.
- Contractual
 - There are no incentive towards intermodality;
- Information
 - There is no public authority responsible for collecting and analysing information on transport supply available as well as on mobility options of the passengers;
- Physical
 - Intermodal terminals are independently developed by local authorities without any regional or long term strategy;
 - Airport is also an intermodal terminal, the development of which is under the responsibility of the airport company.
- Economic
 - Lack of incentives or subsidisation schemes to financing or stimulate intermodal transport;

Work Package 4 identified a total of 4 types of challenges being:

- **Challenge of improving physical interfaces** - refers to barriers, which are related to physical elements of the intermodal transport chain. The issues that arise are mainly related to the planning and design of terminals, the capacity of the infrastructure, as well as the management of physical interfaces.
 - Airport of Faro offers physical conditions for the development of intermodal transport services.

- **Challenge of cooperation among operators** - refers to barriers, which are related to the cooperation and coordination among operators. The corresponding issues comprise integrated planning of services, coordinated schedules, integrated ticketing systems, the exchange and harmonisation of information, as well as common operational standards.
 - Cooperation among operators is rather limited or non-existent;
 - Transport providers consider each other direct competitors and are not willing to cooperate.
 - The airport manager can to some extent communicate with transport providers, but relations are tense.
- **Challenge of passenger information and ticketing integration** - refers to barriers, which are related to insufficient and in transparent information for passengers. It therefore particularly represents barriers for using intermodal transport services from the perspective of passengers:
 - There is no central information office on the transport services;
 - There are no integrated ticketing systems.
- **Challenge of coordinating different stakeholders** - refers to barriers, which are related to the cooperation and coordination between different stakeholders:
 - There is tension between the various transport operators, and between these and the airport manager, which reduces the scope for any kind of cooperation and coordination.
- **Challenge of coordinating public activities** - This cluster refers to barriers, which are related to the role of public authorities and their influence on the provision and improvement of intermodal transport services:
 - There are no public authorities responsible for the development of intermodal transport services.

6.6.8.2 *Missing links and new Value Proposition*

The missing link is the lack of integration between the air and the land-based transport services, which precludes the existence of intermodal transport. The barriers are identified earlier in the report and are visible in the three decision levels.

It is important to recall that the new value proposition (and corresponding business model) is presented from the perspective of the airport manager.

This being said, in order to overcome the current problem and to implement a truly intermodal service between the air and the land based transport services, we propose to include air-land intermodality into the value proposition of the airport manager (which does not occur nowadays). To follow this guideline, we propose to implement a **flexible small-scale collective transport service integrated with the air transport**, in terms of tariffs, scheduling and information. The collective transport service will provide transport to some destinations in the region of Algarve. Passengers would be offered a seamless transport journey, since their airport of origin until their final destination in Algarve. By seamless we understand no (or short) waiting time at the airport and direct transport to final destination. Our proposal is described in detail in the following chapter.

6.6.9 Actions for improvement of interconnectivity

6.6.9.1 Proposal

The problems of interconnectivity identified in the current case study were classified as belonging to Gap 1, concerning the lack of integration between the long and short distance transport services. Consequently, the Business Model herein proposed refers to the so-called BM1 Last Mile, whose objective is to integrate the long and short distance transport service and, in this way, to achieve a seamless transport journey to final destination.

As already explained in previous chapter, we propose to implement a **flexible collective transport service (FCTS) integrated with the air transport**, in terms of tariffs, scheduling and information. The FCTS will provide transport to designated destinations in the region of Algarve. Passengers would be offered a seamless transport journey, since their airport of origin until their final destination in Algarve.

The FCTS may not be financial viable, at least, in the short run. Such risk will certainly prevent private companies to enter the market offering the service (which is what is happening nowadays). As such, stakeholders will have to take the initiative to demonstrate the financial attractiveness of the project. Two main architectures of ownership can be identified, namely:

- Single ownership: Airport Manager takes the ownership of the FCTS bearing the full costs of the service;
- Shared ownership:
 - Hotels and similar take the ownership for the FCTS to their destinations bearing the respective costs;
 - Municipalities take the ownership for the FCTS to the cities bearing the respective costs.

Naturally, a hybrid solution may be foreseen, with the Airport Manager taking the ultimate responsibility and control of the service, Hotels and Municipalities providing financial support to reduce the fixed costs for the Airport Manager, and having a private operator running the service, possibly after an initial period during which the Principal (the Airport manager) has full access to all the relevant information on costs, customer preferences and revenues, during which it can adjust the attributes of the offer and after which it will be in a better position to contract it out. This is the configuration that will be analysed below. The bottom line is that most likely the initial development of the FCTS will require financing from the stakeholders before becoming attractive for other companies.

6.6.9.2 Description of new business model

On this section the proposal created will be described according to Osterwalder building blocks, namely: Customer Segments (CS), Value Propositions (VP), Channels (CH), Customer

Relationships (CR), Revenue Streams (R\$), Key Resources (KR), Key Activities (KA), Key Partnerships (KP) and Cost Structure (C\$).

6.6.9.2.1 Value Proposition (VP)

In this case study, the Business Model is presented from the point of view of the Airport Manager. Also, we concluded that nowadays intermodality is not part of the airport manager's value proposition. Later in the report, we consider that to overcome the current barriers to interconnectivity, the airport must include air-land intermodality in a new value proposition. Our proposal for the new value proposal consists in the implementation of an integrated air-land intermodal transport service that provides seamless transport up to the final destination.

6.6.9.2.2 Customer Segments (CS)

No changes are expected in the building block Customer Segment vis-à-vis the current situation.

6.6.9.2.3 Channels (CH)

The FCTS operator will concentrate all the information about the new service, including schedules and tariffs. The basic sales channel must be a clearly marked counter on the arrivals hall, although it is possibly useful to consider from the beginning a web-based sales channel, to be accessed by passengers or travel agents, basically by whoever makes the reservation for the flight.

Another channel is foreseen, which consists in selling tickets for the new transport service on board aircrafts. This will imply the establishment of a commercial agreement with the air transport companies.

6.6.9.2.4 Customer Relationships (CR)

No changes are expected in the building block Customer Relationships vis-à-vis the current situation, regarding the Airport Manager. But the manager of the FCTS must establish a system for customer relationships, namely for claims, and particularly for objects forgotten aboard the bus, both on the arriving and on the departing bit of their trips.

6.6.9.3 *Revenue Streams (R\$)*

Recalling that our proposal is designed from the perspective of the airport manager, this agent should be the instigator of the new service but not its direct operator, unless no private company is interested (which seems unlikely). So, it would be that company that would collect all the direct revenues from the various sales channels. The Airport, as the Principal for this service would collect the financial support of the Municipalities or Hotels, and make it available to the FCTS operator, after consideration of the (positive or negative) rent allocated to the service

supply. The main stream of revenues will be the tickets sold to customers. Additional sources may include advertisement on board the vehicles or on the internet website. Depending on the nature of the contract between the Airport Manager and the FCTS operator, different rules will apply to the operational profits or losses of this new service.

6.6.9.3.1 Key Resources (KR)

The FCTS will entail a new set of resources, including:

- Fleet of vehicles (mini-bus, mini-vans);
- Drivers and other administrative staff
- Building (administrative office, for parking, cleaning and maintaining the vehicles)
- IT infrastructure (hardware and software)

The specific amount and type of resources will depend on the final architecture of the FCTS, and in particular, if some of the activities are outsourced to third parties.

6.6.9.3.2 Key Activities (KA)

Our proposal foresees a new key activity which is the new flexible collective transport service.

6.6.9.3.3 Key Partnerships (KP)

The business model we are herein proposing is based on the establishment of partnerships between several stakeholders, namely: airport manager, air transport companies, hotels and municipalities.

- **Hotels - airport manager:** hotels may establish partnerships for sharing the risk of the FCTS operation, or at least establish partnerships for joining transport resources (e.g.: the same vehicle may transport passenger for various hotels).
- **Municipalities - airport manager:** like hotels, municipalities may establish partnerships for sharing the ownership of the FCTS provider, or at least establish partnerships for joining transport resources (e.g.: the same vehicle may transport passenger for various municipalities).
- **Airport Manager - FCTS operator:** After the above partnerships have been established, the Airport Manager will be in a position that allows it to define the nature and intensity of the service to be offered with an acceptable expected range of results, and this should serve as the basis for a "call for tenders" to licensed transport operators. Following this competitive process, a contract would be signed, defining the rights and duties of each party as well as the rules regarding investment funding and sharing of results.
- **Airport Manager - air transport companies partnership:** our proposal foresees the selling of tickets on board aircraft, which entails a commercial agreement between them.

6.6.9.3.4 Cost Structure (C\$)

The cost structure of the proposal refers to the cost structure of the new FCTS provider. There were a variety of costs considered may be divided in implementation costs and operational costs.

Implementation costs include the acquisition of vehicles (the number of vehicles to acquire was calculated based on the number of trips per destination and the type of vehicle to use was determined according to the demand), infrastructure costs (terminal, office rent) and other costs, like the implementation of an informational website and others.

Operational costs refer to the fuel consumptions (based on the distances between each city and the airport), tolls to be paid on some connections, annual maintenance of vehicles, insurance costs, annual taxes, human resources wages (drivers and other staff), and communication costs.

As mentioned above, the Airport Manager is the Principal of this service and it should be able to establish what part of the costs, if any, should not be falling on the FCTS operator.

6.6.9.4 *Description of proposed service using the concept of Agents*

On this section the proposed business model will be described using the concept of agents. Comparing with the current business model, the proposal has but one change related with the introduction of the FCTS provider.

First, the new agent (the only new agent that appears when the business model is introduced) will be identified and described in terms of objectives, goals, and strategies. The interactions of the first with other agents will be also described, along with a graphical representation of the business model.

6.6.9.5 *Agents*

Comparing with the current business model, there is the introduction of one new stakeholder: the FCTS provider. This agent will provide airport-to-door transport services integrated with air transport services. The main objectives of this new operator are to transport services with the following properties:

- **easy to understand:** meaning that information about timetables, tariffs and transport time are easily available (on the web, at the airport, but also in Hotels and a few selected places in the towns for the return trips), and meaning that good visual information is available at airport so that passengers easily understand the way to the vehicle;
- **integrated with air transport:** meaning that passengers will have immediate transport (or a minimum waiting time) collecting their baggage and leave the terminal;
- **fast:** meaning that the transit time must be similar to the taxi and private shuttle services, which implies small vans and few stops;
- **comfortable:** meaning that enough seats are available to carry groups of passengers (families or friend) and that they would be safe and relaxed while on-board;
- **affordable:** meaning that passengers would pay less than going by taxi, and desirably a bit below one half of the taxi price for the same ride, so that it could be pricewise attractive to groups of two.

Of course it must be remembered that this service should be offered outbound from the airport (that is the first contact for the main client segment – tourists) but also inbound to the airport, as

air passengers prepare to depart the Algarve. This has important implications, namely for the visibility of the stopping points of the FCTS (the location of which is the competence of municipalities) and the timetable of the bus services, which must be connected to the departures timetable at the airport.

6.6.9.6 *Interactions between agents*

Besides the current interactions already depicted in previous chapter, the new FCTS provider will interact with several other stakeholders. Naturally, that the actual web of interactions depends on the structure of ownership, we are here assuming that the new FCTS provider is contracted by the airport manager, who receives financing support from Hotels and municipalities. In this case, the new interactions are as follows:

- **FCTS provider – passengers:** there is a commercial interaction in which the former provides seamless transport with the air connection to the latter;
- **Airport manager - FCTS provider:** there is a principal – agent relationship under a contract for a relatively long period – at least one year);
- **FCTS provider – air transport provider:** commercial interactions (selling of tickets);
- **FCTS provider – hotels:** cooperation interaction, by which the hotels rely on the FCTS provider to carry their guests (possibly sharing the vehicle with other hotels' guests) and give the Airport Manager some financial support to help cover the fixed costs of the service;
- **FCTS provider – municipality:** cooperation interaction, by which the municipalities create or make available places for leaving and taking passengers at specific locations and give the Airport Manager some financial support to help cover the fixed costs of the service.

6.6.9.7 *Graphical representation*

The following graphic presents the new business models using the concept of agents (Figure 6.275). As we can observe the main difference is the introduction of the new FCTS provider and the establishment of an interaction with several other stakeholders.

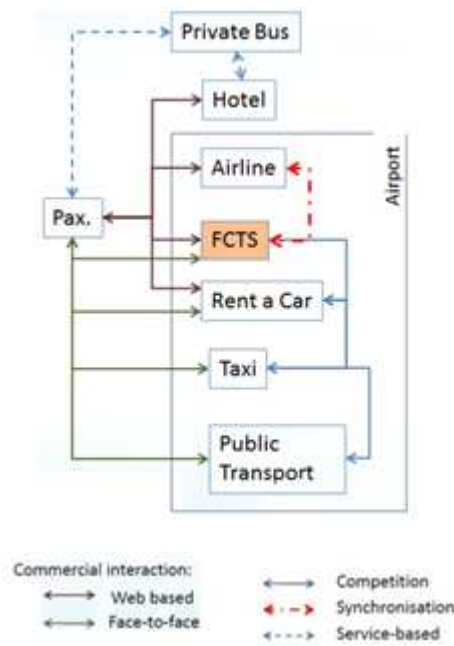


Figure 6.275 Agent Based Model Graphical representation of new Business Model

6.6.9.8 Functions and Indicators to show enhancement

The demonstration of viability of the proposal was based on two pillars, being:

- A survey conducted at the airport of Faro at the beginning of September 2011 and with a total of 1012 answers. The purpose was to grasp the passengers' likely reaction and participation in the new service.
- An economical demonstrator that computed the expected costs and revenues for a reduced set of top destinations. The purpose was to show the likely economical viability of the service.

6.6.9.9 Demonstration and Evidence of Improvement

6.6.9.9.1 Survey

Survey conducted at Faro Airport had a few questions regarding some aspects of the proposed service. The obtained results are presented below.

We ask what passengers' opinion was on having an integrated ticket that they can use to flight and also to reach their final destination from Faro Airport. Figure 6.276 shows the obtained results. Surprisingly, 17 % of the interviewed answered that this was not a good idea.

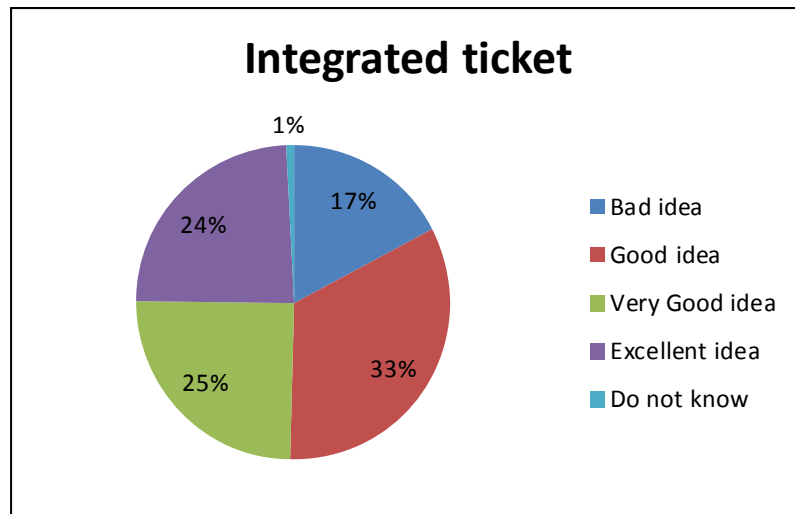


Figure 6.276 Passengers opinion about an integrated ticket

Figure 6.277 shows the obtained results when we ask passengers what they think about the possibility of buying a ticket from the airport to their final destination on board. Only 23% of the interviewed answered that this was a bad idea. We think that this answer may come from passengers that usually do not organize their trips and recur to travel agencies.

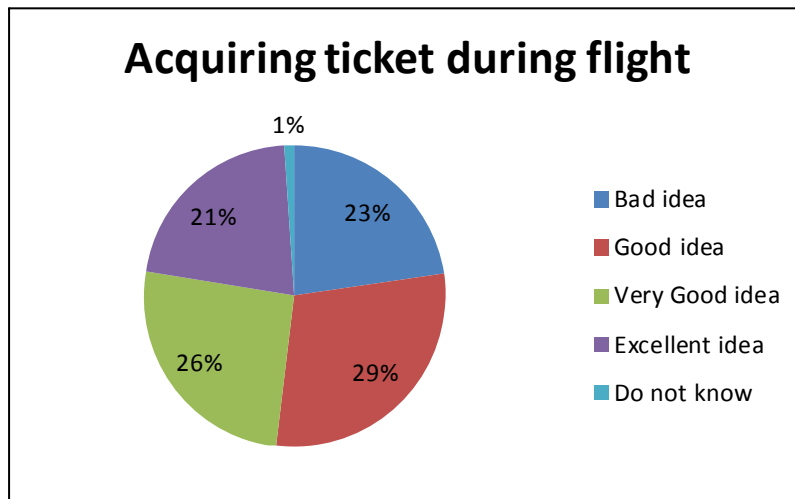


Figure 6.277 Passengers opinion about acquiring a ticket during flight

When we ask passengers opinion about buying the ticket at the airport instead of during the flight, 32% answered that this was a bad idea. We believe that these interviewed represent a group that prefer to buy the ticket during the flight. Figure 6.278 shows the results.

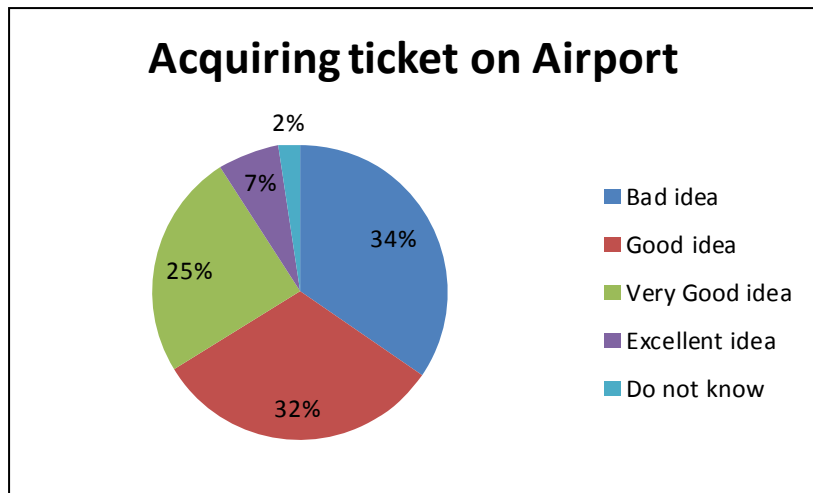


Figure 6.278 Passengers opinion about buying a ticket on Airport

The last two questions were about the transport service itself. We ask if they saw any inconvenience on travelling on a mini-bus with other passengers, and 36% of the interviewed said yes. Figure 6.279 show the results.

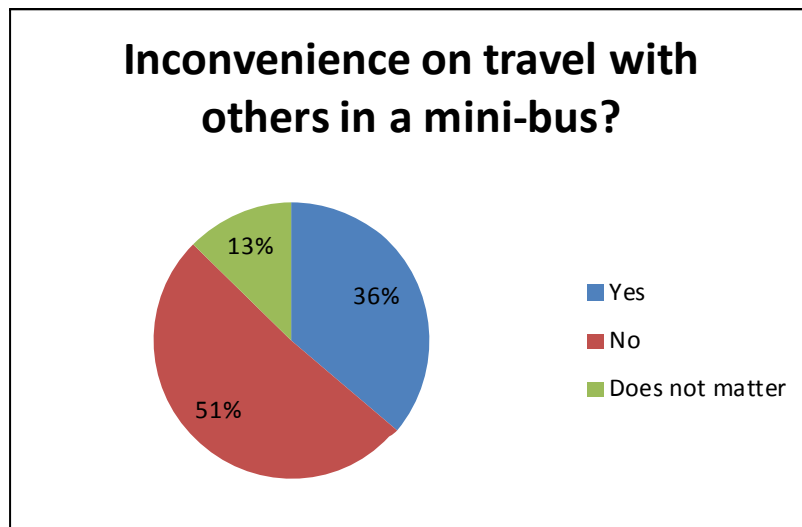


Figure 6.279 Passengers opinion about sharing a mini-bus

Lastly, we ask passengers how long are they willing to wait for this mini-bus. 42% of the interviewed answered 10 minutes and 26% 20 minutes. Figure 6.280 shows these results.

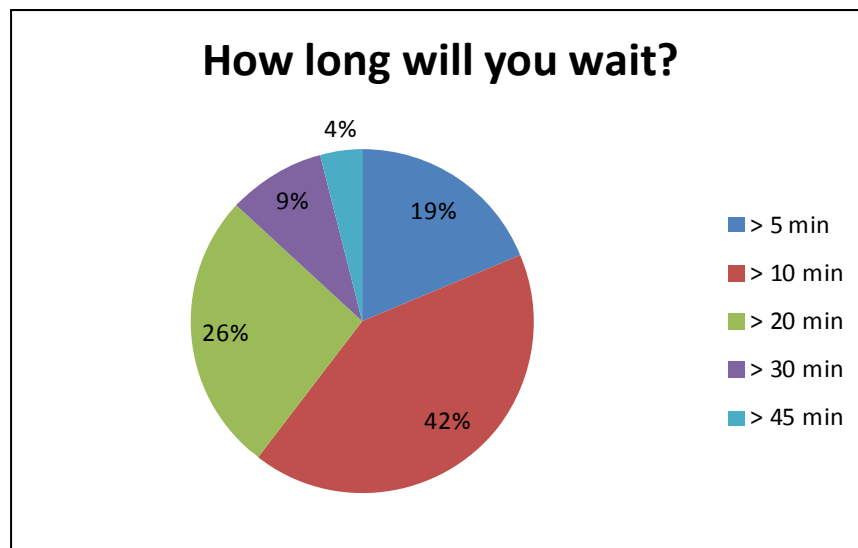


Figure 6.280 Passengers opinion about the maximum waiting time

6.6.9.10 Economical Demonstrator

6.6.9.10.1 Introduction

This chapter contains the description and results of the economical viability exercise of the proposed transport service to service a set of designated destinations. The revenues were computed based on a potential demand, whereas the costs were computed based on a variety of factors including number of vehicles needed, distances between cities and Faro Airport, or prices of petrol.

For the computation of the daily and early costs we considered that one month has 30 days and that one year has 365 days.

Potential Demand

The demand of passengers was calculated from the current amount of passengers using the airport of Faro. We assumed that passengers currently using private cars (including those riding with family and friends) and rented cars are captive and therefore will not shift to the new service. This leaves that the potential passengers are those that nowadays go by: taxi, private shuttling and public bus. We considered two scenarios on the expected shift of passengers:

- Best case scenario - a shift of 2/3 of passengers towards the new service;
- Worst case scenario - a shift of 1/3 of passengers towards the new service.

The modal distribution of the passengers in the year 2010 was as follows:

- taxi: 19.4%
- private bus: 19.8%
- public bus: 1.3%

- private car: 4.9%
- rent-a-car: 42.5%

The passengers that use private or rented car were considered to be captive and, thus, out of reach by the new service.

In terms of destinations and for viability assessment only, we considered the top 7 destinations, being (the percentage value refers to the percentage of passengers going to that destination):

- Albufeira: 24.7%
- Portimão: 13.8%
- Vilamoura: 12.0%
- Tavira: 10.1%
- Lagos: 8.2%
- Faro: 7.1%
- Almancil: 6.8%

In what concerns the number of passengers, we computed the demand per flight assuming a load factor of 90% and a maximum capacity of 150 seats (this roughly corresponds to a short range aircraft).

The potential demand of passengers per final destination and for each scenario can now be computed as follows:

Potential demand to destination i =

Percentage of passengers to destination i *

Total number of passengers per flight *

Potential shift of passengers that would use the new service

The following table presents the potential demand for each scenario.

City	Best Case Scenario	Worst Case Scenario
Tavira	3.89	1.92
Albufeira	9.51	4.70
Portimão	5.31	2.63
Vilamoura	4.62	2.29
Lagos	3.16	1.56
Faro	2.73	1.35
Almancil	2.62	1.30

Figure 6.281 Expected passengers per destination and per flight

Fleet Dimensioning

The fleet was dimensioned to provide a minimal quality of service to the passenger. In turn, the quality of service was determined in function of the passengers' maximum waiting time for the transport service at the airport. In this case, the maximum waiting time was considered to be 15 min. The time was determined based on the survey conducted at the airport.

The next table presents for each destination: the distance to the airport, the expected travel time and the expected round trip time. The round trip time also includes the time of distribution at the final destination.

The distribution included the passengers' drop off time and the travel time between destinations. A total time of 2.5 minutes per stop plus a total time of 10 min for transport between destinations were considered.

City	Distance to the Airport	Travel Time	Round Trip Time
Tavira	40	40 min	100 min
Albufeira	50	45 min	110 min
Portimão	75	60 min	140 min
Vilamoura	25	30 min	80 min
Lagos	95	70 min	160 min
Faro	7	15 min	50 min
Almancil	25	45 min	160 min

Figure 6.282 Expected passengers per destination and per flight

The fleet was determined in function of scheduled of the flights, the round trip time and the maximum waiting time. As explained, the maximum waiting time per passenger was of 15 min, which in the peak demand periods, could be enough to gather passenger from different flights. For each trip a Bus of 15 or 24 was used as a function of the demand (whenever the demand was higher than 24, more than one bus was deployed). The total number of buses is presented in the following table:

BUS	Best Case Scenario	Worst Case Scenario
15	37	40
24	5	1

Figure 6.283 Number of buses

The number of drivers was computed based on the number of hours of utilisation of each bus. The maximum legal daily driving time in Portugal is of 8 hours. The expected number of drivers is of 76 in the best case scenario and of 74 in the worst case scenario.

Cost Items

The costs considered for the implementation of the new business model were divided in Implementation Costs, Operational Costs, and Others. Figure 6.284 Costs considered for the proposal of new business model resumes the costs referred and estimated the value considered for each of them.

Implementation costs	Acquisition of vehicles	The number of vehicles was determined according to demands and schedules for each city. The following vehicles were considered: <ul style="list-style-type: none"> - 15 passengers: Acquisition value of 73000€ - 24 passengers: Acquisition value of 105780€
	Infrastructure	Infrastructure costs were considered to be 2000€ per month and include costs with office rental and terminals (which do not involve significant costs due to being a door-to-door service).
Operational costs	Fuel consumptions	Calculated based on the distances between Faro Airport and cities connected by the service, on the number of trips to be performed, on the consumptions of the vehicles considered, and on the price of fuel. <p>Fuel consumptions of the vehicles:</p> <ul style="list-style-type: none"> - 15 passengers: 15l/100km - 24 passengers: 22l/100km <p>Price of fuel considered: 1.50€/l</p>
	Tolls	Three of the destinations considered (Tavira, Lagos and Portimão) are far enough to consider the use of highway, which will soon have a toll associated. Costs were calculated according to the number of trips to these destinations.
	Maintenance	For maintenance, a cost of 1500€ per vehicle, per year was considered.
	Insurance	For insurance, a cost of 800€ per vehicle, per year was considered.
	Annual taxes	Annual taxes were considered to be 200€ per vehicle per year.
	Human resources	The wages considered for drivers were 800€/month. For wages referring to other staff and administration it was considered a cost of 5500€/month (this value considers 5 staff members with a monthly salary of 800 € and one manager with a monthly salary of 1500 €).
	Communications	The costs considered for communications were 500€/month.
Others	Website, others	On the category of other costs, which include costs associated with the website, an additional 5000€/year was considered.

Figure 6.284 Costs considered for the proposal of new business model

6.6.9.10.2 Results

In the viability exercise herein presented, the service connects the airport of Faro with the 7 cities with higher demand of passengers, namely Albufeira, Vilamoura, Portimão, Lagos, Tavira, Faro and Al Mancil. The costs of the service were calculated based on implementation costs (website, infrastructure, acquisition of vehicles, etc) and operational costs (calculated based on the distances between the airport and destination cities, fuel prices, and tolls).

The next table summarises the costs obtained for each destination. The last row presents the cost per expected client that would correspond to the breakeven of the costs of this service. As we can observe, the expected costs per passenger, in both scenarios, are considerably lower than the prices being currently offered by the taxi and private shuttle (Figure 6.255 Some Bus connections from Faro city center (Source: EVA – Transportes website)Figure 6.255 and Figure 6.256). Moreover, the new transport service as we propose herein will provide a tailored service of similar quality of service than the current ones. Therefore, we may conclude for the likely economical viability of our proposal.

	Tavira	Albufeira	Portimão	Vila Moura	Lagos	Faro	Almancil
Fixed Costs	244,50€	378,60€	244,50€	244,50€	240,10€	240,10€	240,10€
Variable Costs	715,50€	1154,60€	1261,80€	450,30€	1563,00€	317,80€	476,70€
Total Cost	959,90€	1533,20€	1506,20€	694,80€	1803,1€	558,00€	716,90€
Expected demand	252,00 pax/day	630,00 pax/day	315,00 pax/day	315,00 pax/day	189,00 pax/day	189,00 pax/day	189,00 pax/day
Cost per customers	3,81€/pax	2,43€/pax	4,78€/pax	2,21€/pax	9,54€/pax	2,95€/pax	3,79€/pax
Taxi costs	60,00 €	45,00 €	80,00 €	35,00 €	100,00 €	20,00 €	35,00 €
FCTS 20% increment	4,57 €/pax	2,91 €/pax	5,73 €/pax	2,65 €/pax	11,45 €/pax	3,54€/pax	4,55 €/pax

Figure 6.285 New service's cost break down per day (best case scenario)

	Tavira	Albufeira	Portimão	Vila Moura	Lagos	Faro	Almancil
Fixed Costs	243,30€	285,80€	243,30€	243,30€	243,30€	243,30€	243,30€
Variable Costs	705,60€	820,00€	1233,60€	450,60€	1571,80€	349,50€	525,50€
Total Cost	948,90€	1105,70€	1476,90€	693,90€	1815,20€	592,80€	768,80€
Expected demand	126	315	189	126	126	63	63
Cost per customers	7,53€	3,51€	7,81€	5,51€	14,41€	9,41€	12,20€
Taxi costs	60,00 €	45,00 €	80,00 €	35,00 €	100,00 €	20,00 €	35,00 €
FCTS 20% increment	9,04 €	4,21 €	9,37 €	6,61 €	17,29 €	11,29€	14,64 €

Figure 6.286 New service's cost break down per day (worst case scenario)

6.6.9.11 Conclusions

We propose to implement a **flexible collective transport service (FCTS) integrated with the air transport**, in terms of tariffs, scheduling and information. This service will provide transport to passengers from the airport to designated locations in the region of Algarve. Passengers would be offered a seamless transport journey, since their airport of origin until their final destination in Algarve. By seamless we understand an integrated ticket, no (or low) waiting time at the airport and direct transport to final destination. Our proposal for the new value proposal consists in the implementation of an integrated air-land intermodal transport service that provides seamless transport up to the final destination.

The viability analysis of this service consisted in a survey at the airport and an economical viability exercise. The survey evidenced the absence of concerns or other barriers to the proposed service, by the passengers. The economical viability exercise included two scenarios of expected (worst case scenario and best case scenario). We considered the main costs items such as: vehicle's acquisition and maintenance, fuel and tools, drivers, communications, or equipment's and buildings. The fleet was dimensioned in function of the expected demand (buses with 15 or 24 seats), the distances (transport time) and the maximum awaiting time for

the customers. The maximum waiting time was set to 15 minutes, which is in line with the results of the survey.

The results show in both scenarios the expected cost per passenger feels well below the current prices offered by the taxi and private shuttle, which would be the main competitors of this service. The expected costs of the new service per passengers are over 50% lower than the current prices demanded by the taxi and private shuttle, which supports our claim of viability of the proposed service.

There are favourable conditions supporting the implementation of our service, namely:

- ANA, the entity that manages the airport, is interested on improving land transport services;
- Currently transport modes at the airport do not satisfy passengers for several reasons: unclear fares (taxis), non-coordinated schedules (public bus);
- In most cases passengers are travelling with their families and luggage that a taxi is not capable to transport, which requires two vehicles and cost the double;
- Hotels that currently provided private bus services could be a potential partner on our new service, since their fixed costs with vehicles maintenance disappear;

6.6.9.12 Added value from the case study to the HERMES project

The airport of Faro is the main gateway to the tourist region of Algarve. Over the last years, owing to a growing tourist market fuelled by the entry of multiple low cost companies the airport recorded a constant growth. In the year 2010, the number of passengers was near the 8 million passengers.

Despite its relevancy for the economic development of the region, the airport is underserved by the land based transport services. There are no rail or metro services linking the airport with the region, and there is only one bus service with low frequencies. The single viable alternative in what concerns the public transport service is the taxi. Alternatively, passengers may rent a car or a private shuttle. The current modal distribution reflects the lack of adequate public transport services, forcing passengers to resort on alternative transport solutions.

Consequently, integration between the air transport and the land based transport services are non-existent, and passengers have to build their transport chain leg by leg. In this sense, the airport infrastructure is a simple transfer node between transport services. The lack of integration naturally undermines the quality of the transport service.

In HERMES project, the airport of Faro is one of the three case studies concerning airports. As explained above, the current problems affecting the intermodal transport are related with the lack of integration between transport services at the airport. Recalling the two types of problems of intermodality identified in HERMES project, being: issues with links and issues with nodes.

This case study refers to a situation in which the problems of intermodality are related with issues in the links.

The business model of our proposal corresponds to the Prototype of Business Model 1, therefore, the demonstration and evidence of improvement contributes to support the validity of the Prototype of Business Model. Our proposal envisages a new transport service linking the airport with designated destinations in the Algarve region and fully integrated with the air transport services. Both the perspective from which the business model was designed as well as the value proposition are aligned the prototype of business model. The business model was designed from the perspective of the airport manager, which is the party responsible (and with higher interests) for promoting quality in intermodality. The value proposition of the proposed business model is aligned with the with the value proposition of the prototypes, being the implementation of an integrated air-land intermodal transport service that provides seamless transport up to the final destination, aimed to improve the passenger's quality of transport or reduce price.

The demonstration of improvement evidenced the viability of our proposal. We have developed two exercises: a survey to the passengers and an economical viability assessment. The former concludes for the likely acceptability of passenger to the new transport service; whereas the latter concludes for the potential competitiveness (and probable financial viability) of the proposal.

Recalling that our proposal embodies the Prototype of Business Model 1, therefore the evidence of viability of our proposal is inherently contributing to the evidence of viability of that prototype.

6.7 Antwerp Airport, Belgium

The following chapter describes the characteristics of Antwerp Airport and gives a background picture on interconnectivity problems/opportunities and the current value proposition.

6.7.1 Main features of the site

Antwerp (500 000 inhabitants) is located in Flanders (6 000 000 inhabitants) which lies in Belgium (10 500 000 inhabitants). Belgium and Flanders are in heart of Europe and thus the logistics Blue Banana. Antwerp is the second biggest Belgian city and the second largest European port is located there. Antwerp is also known for its diamond industry and chemical sector. The combination of these factors contributes to the fact that Antwerp Airport attracts a lot of business people.

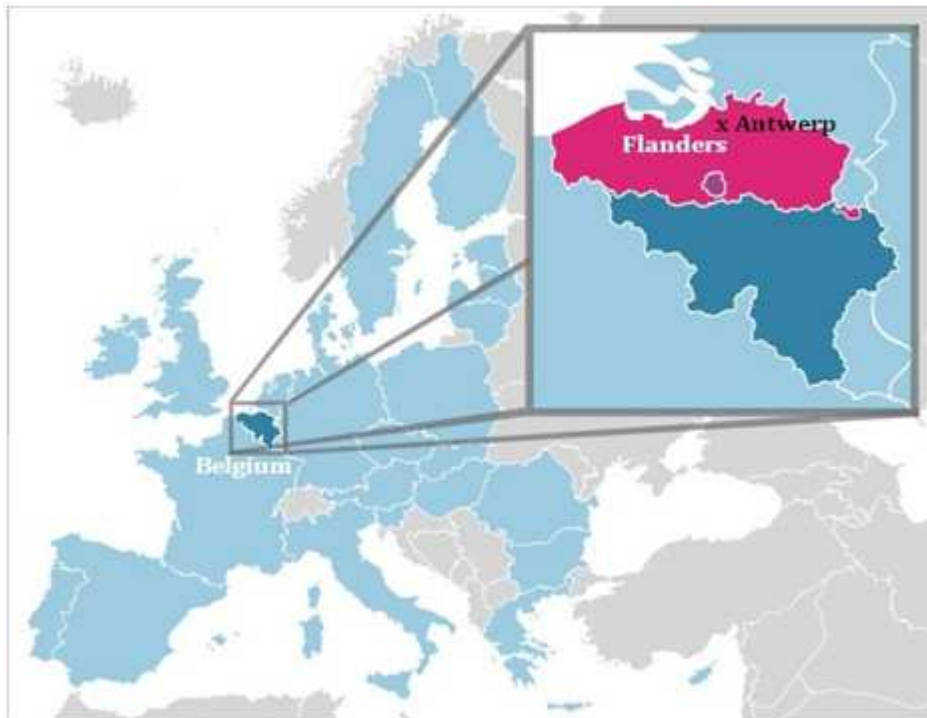


Figure 6.287 Map of Belgium and Flanders Source: Own composition based on existing map

Antwerp Airport mainly focuses on business travel, but a market opportunity can be found in offering leisure flights.

The total area of the airport amounts to 167ha and it is accessible by car/taxi or by bus.



Figure 6.288 Aerial photo of Antwerp Airport Source: Google Maps

6.7.1.1 Identification of the site

In this paragraph, the geographical coverage, the available transport modes and the services per transport mode are described.

Transport modes	Rail	Bus	Air	Car	Ship and ferry
Geographical coverage	Rail services	Bus services	Air services	Car services	Ship and ferry services
a) Long distance services >100 km	1) International rail service	1) International bus service	1) International air service	1) Taxi 2) Mobility service for passengers with disabilities	1) International ship service (ocean liners) 2) International ferry service
b) Long distance air services >700 km	2) Interurban rail service	2) Interurban bus service	2) Interurban air service	3) Privat car 4) Rental car	3) Port-to-Port ferry service
a) Short distance services <100 km	1) Metro service 2) Tram service 3) Commuter train service	1) Interurban bus service 2) Urban bus service	1) International air service	1) Taxi 2) Mobility service for passengers with disabilities	1) Port-to Port ferry service 2) Pier-to-Port ferry service
b) Short distance air services <700 km	4) Interurban rail service	3) Shuttle service	2) Interurban air service	3) Privat car 4) Rental car	3) Pier-to-Pier ferry service

Figure 6.289 Long-distance services per mode and short-distance services per mode

6.7.1.1.1 Geographical coverage

Antwerp Airport is a site where the short distance air transport meets up with short distance land transport (car/taxi and bus). Airplanes departing from Antwerp Airport fly to London City Airport and to Manchester⁵. At the land side, the available modes only cover relatively short distances.

6.7.1.1.2 Transport modes

There are free car parking places next to the airport building and car rental companies are located in the airport building. Thanks to the bus stop near the airport, there are frequent bus services to two nearby train stations (15 min. ride).

⁵ Distance Antwerp to London City: 308 kilometers; distance Antwerp to Manchester: 516 kilometers (source: World Airport Codes)

6.7.1.1.3 Services per transport mode

6.7.1.1.4 Air transport

There are about 5 flights a day scheduled⁶ to London City and 2 flights to Manchester. During the holiday season (months July and August), the frequency of the flights is lower. These flights are performed with small airplanes (Fokker 50).

6.7.1.1.5 Car/taxi

Next to the airport building, there are about 500 free parking⁷ spaces. Furthermore, in the airport building, there are offices of car rental companies and several taxis are available to bring the arriving passengers to their final destination.

6.7.1.1.6 Bus

There are three bus lines that have stops near the airport building: line 14⁸, line 21 and line 33. About every 15 minutes, there is a bus that brings the traveller to the two nearest train stations (15 min. ride) or to the city centre of Antwerp (20 min. ride).

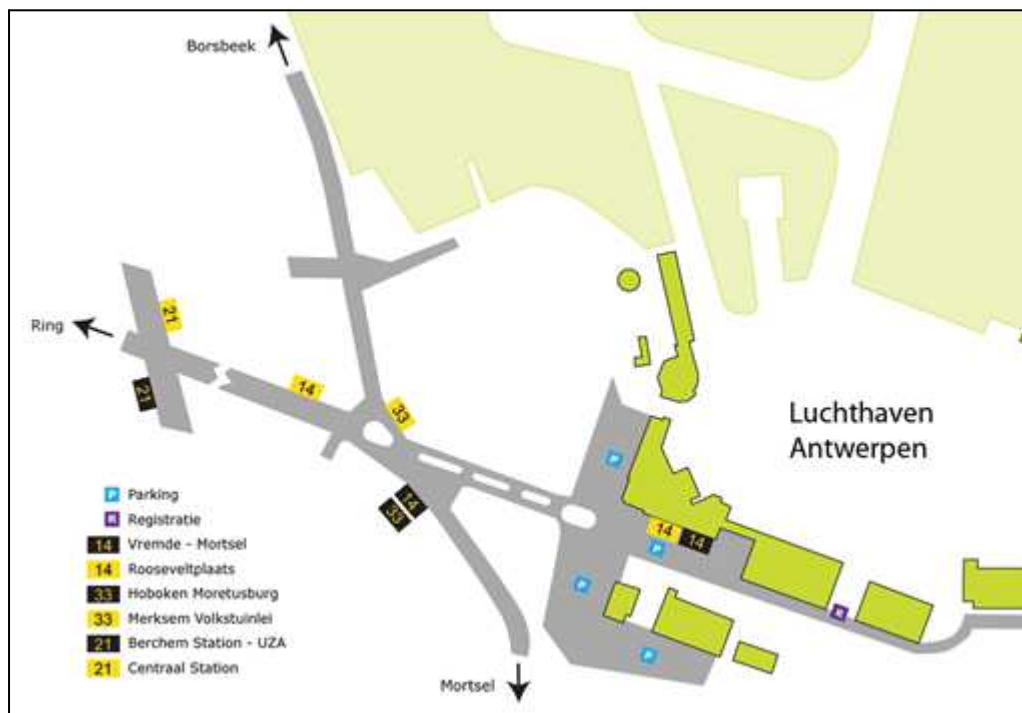


Figure 6.290 Map of Antwerp Airport with indications of bus stops Source: Website Antwerp Airport

⁶ At Antwerp Airport, not only scheduled flights are organised. On the site, there are some companies that organise private business trips etc.

⁷ This parking is not guarded.

⁸ The stops of line 14 are located next to the entrance of the airport building.

6.7.2 Method for data collection

To get a clear view on this Case Study, Antwerp Airport, data were gathered by observations, a survey amongst the customers and interviews with the major stakeholders. In this section, these methods are described further.

6.7.2.1 Observations and collected material

Looking at different information channels (internet, brochures, annual reports, ...), one can get a view on how Antwerp Airport is organized. These information sources were then compared to and supplemented by observations at the site.

6.7.2.1.1 Transport demand/Passenger flow

Antwerp Airport serves two destinations: London (City) and Manchester. The majority of customers are business travellers, commuting to the UK.

When comparing Antwerp Airport to the other Belgian regional airports (Charleroi, Kortrijk, Liège and Ostend; Figure 6.291 and Figure 6.292), one can see that Antwerp Airport represents a rather low number of passengers and tonnage⁹.

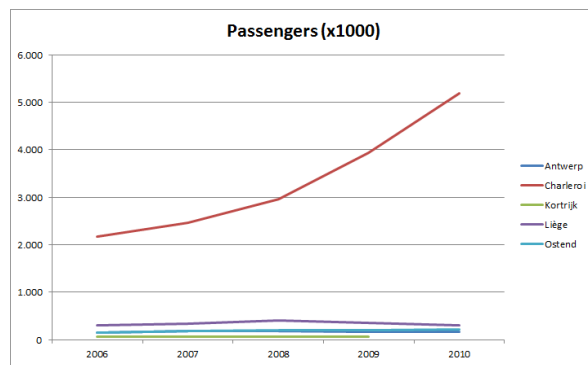


Figure 6.291 Comparison of Belgian regional airports, in terms of passengers

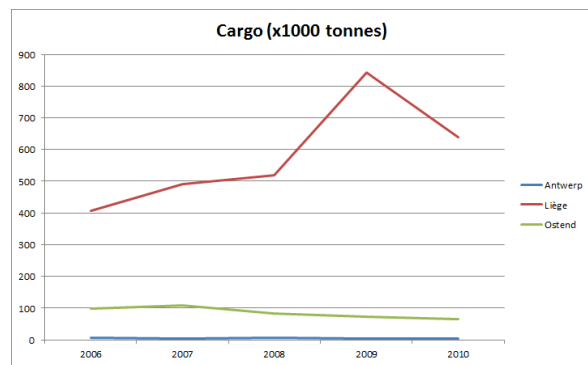


Figure 6.292 Comparison of Belgian regional airports, in terms of cargo

	Passengers	Movements	Cargo (in tonnes)
2000	261,576	66,909	7,997
2001	273,208	69,515	6,684
2002	190,362	67,435	5,240
2003	168,283	64,000	4,903
2004	152,682	58,132	4,281
2005	142,737	54,871	4,664
2006	147,849	55,023	6,825
2007	174,858	51,589	5,312
2008	176,971	56,072	5,562
2009	169,446	60,266	4,592

⁹ Charleroi Airport and Kortrijk Airport are not included in the graph that compares cargo, because those airports do not handle cargo.

2010	162,840	51,703	4,213
-------------	----------------	---------------	--------------

Figure 6.293: Traffic evolution Antwerp Airport 2000-2010 Source: Annual report 2009 Antwerp Airport
Source: Own composition based on information found on the website of the airports

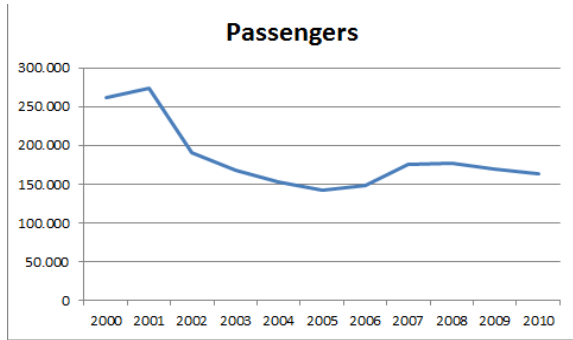


Figure 6.294 Passenger traffic at Antwerp Airport

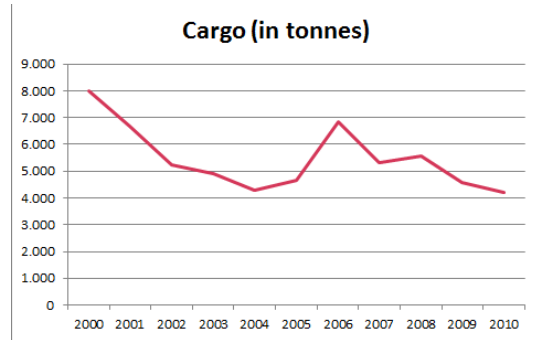


Figure 6.295 Cargo traffic at Antwerp Airport

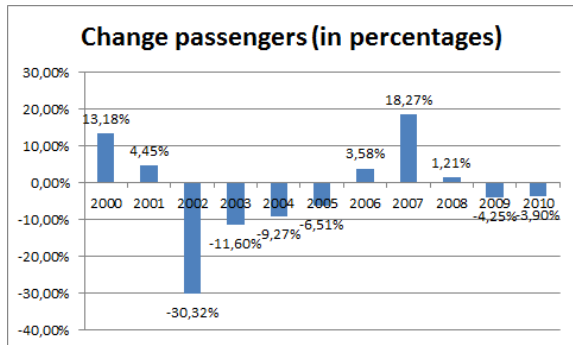


Figure 6.296 Evolution of passenger traffic at Antwerp Airport

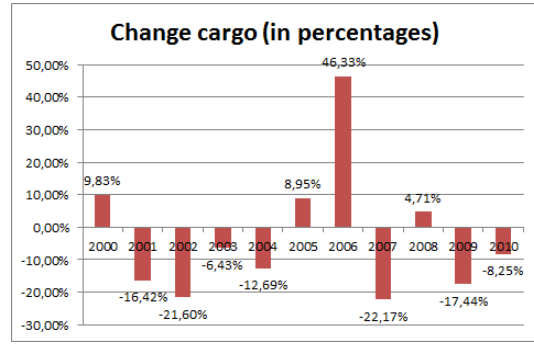


Figure 6.297 Evolution of cargo traffic at Antwerp Airport

Antwerp Airport

Source: Own composition based on annual report 2009 Antwerp Airport

The figures above give an overview of how traffic has evolved the latest years. One can clearly see that in 2002, passengers as well as cargo dropped drastically. The number of passengers has been rising ever since, but dropped again in 2009 and even further in 2010 to 162,840 passengers. The number of tonnes of cargo handled at Antwerp Airport has been fluctuating.

6.7.2.2 *Time data*

Antwerp Airport presents itself as a modern, fast and customer friendly airport, with a focus on business travellers. The airport has some specific characteristics (such as a 20 minute check-in concept, a large free parking at the airport building) that offer the advantage of saving time to the customers. Given the size of the airport, passengers do not have to walk long distances to and from the access mode or gate.

6.7.2.2.1 Service time

Although ticket counters are present, most travellers have bought their ticket upfront, through travel agencies, via internet, etc. Therefore, no time is needed for ticket purchasing. Check-in counters open one hour before and close 20 minutes before departure of the flight. The fact that most passengers are business travellers also has consequences for the time data: most passengers frequently visit the airport and are in no need of information and travellers which are commuters do not travel with luggage. This reduces time for getting information and baggage drop off time to zero.

6.7.2.2.2 Waiting time

Thanks to the 20 minute check-in concept, travellers can check in until 20 minutes before departure. Therefore, there is a waiting time of minimum 20 minutes.

6.7.2.2.3 Transboarding time

Transboarding time is the total time required to change from one mode to another. This includes service time, waiting time and the time to move around (A).

The figure below shows that the walking distances around and within the Antwerp Airport building are relatively small. This reduces the time the traveller needs to move around to about 10 minutes in total.

Given all this, one can calculate that the transboarding time adds up to maximum 1 hour and 10 minutes, see figure below.



Figure 6.298: Picture of the Antwerp Airport site, with walking distances Source: Own composition based on existing picture (Google Maps)

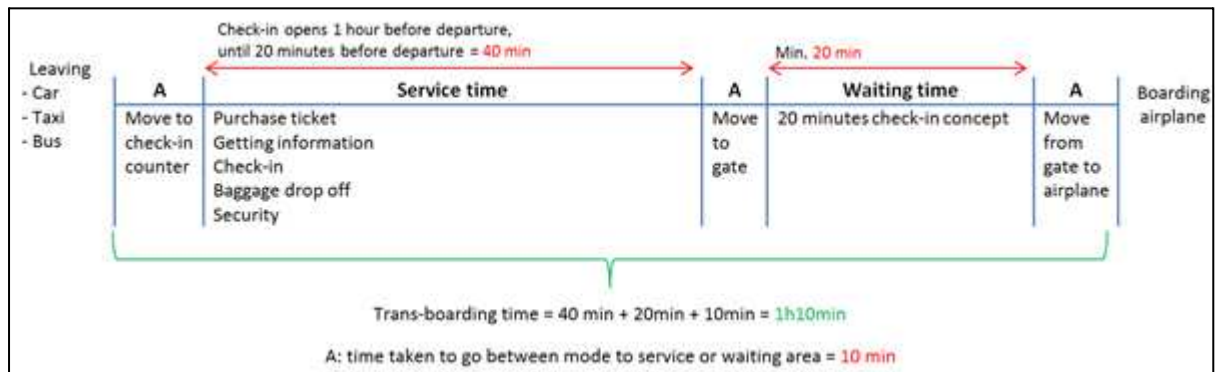


Figure 6.299: Time division at Antwerp Airport Source: Own composition based on existing figure

6.7.2.3 Space data

Antwerp Airport has a relatively small airport building and, as can be seen on Figure 6.300, every passenger area at Antwerp Airport is on the ground floor. The offices of the airport management and the carrier CityJet are located at the first floor, which has the same dimensions as the ground floor. The first floor is accessible by stairs or by an elevator, centred in the airport building.

At the passenger level, the different services are located close to each other, which makes maximum use of the space available. Therefore, walking distances in between the services are relatively short. Since the check-in area is close to the entrance, which is close to the parking space, no luggage trolleys are needed. In the airport building, seats are available, but only in limited number. The main waiting area is at the gate; there are plenty of seats. The limited waiting time also implies that the lounge is underused. Only when airplanes are delayed, the lounge is used to house the waiting travellers.

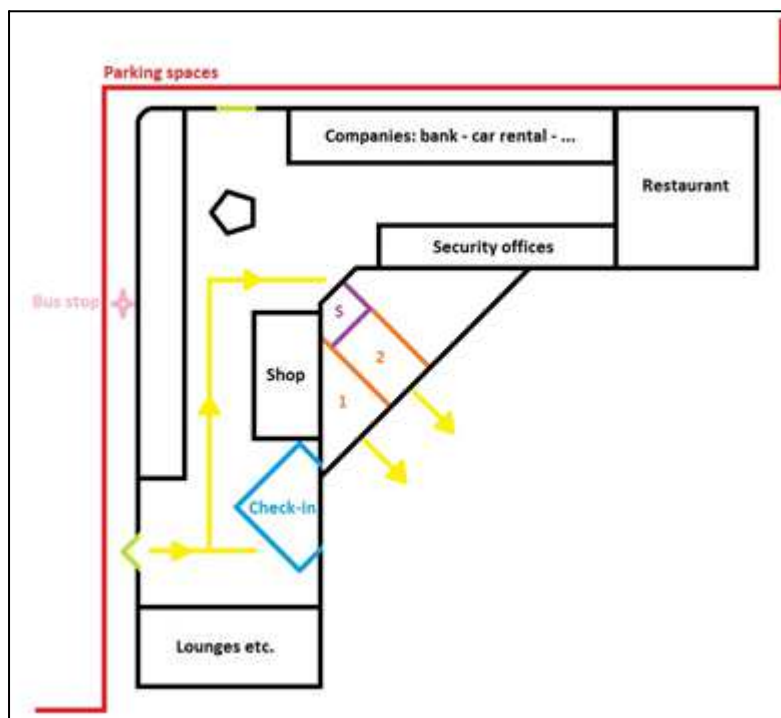


Figure 6.300: Map of Antwerp Airport with indications of space usage

Source: Own composition

6.7.2.4 Information, Ticketing and Check-in Services data

Given the short distances, information signs are not needed: most of the passengers know their way around the site and the others follow the passenger flow. Since there is a short check-in time, the majority of the passengers arrive at the airport and check in at the same time. This makes following the crowd possible. As stated before, most of the passengers have bought their

ticket beforehand and some of them have already checked in online. This reduces the length of the queues at the check-in and ticket desks.

6.7.2.5 *Customer survey*

In this section, the prerequisites and possibilities for performing the customer survey at the site are described.

6.7.2.5.1 Sample size

Given the nature of the passengers at Antwerp Airport and the limited number of destinations offered, there are little departing and arriving flights per day. The morning flight and the evening flight are mostly fully booked, but on the flights during non-peak hours, a lot of seats usually remain free. Furthermore, business travellers live by the concept “time is money” and during waiting, they either want to work or relax and read the newspapers. Either way, they do not want to be disturbed. This makes performing surveys rather difficult. Moreover, the survey was relatively long and it took quite some time (5 to 10 minutes) to question the travellers. Given that passengers are only available for questions during the 20 minutes that they have to wait, not a lot of surveys could be performed per flight.

This makes that only 43 questionnaires were completed. However, again given the nature of the passengers, this showed to be enough to draw conclusions: the majority of the passengers has the same profile and thus responds in the same way.

6.7.2.5.2 Distribution of the questionnaires

To perform the surveys, the airport management allowed us to stand at the gate. This was the only way the waiting travellers could be approached.

6.7.2.6 *Stakeholder interviews*

At Antwerp Airport, there is a bus stop next to the entrance of the airport building. Every 15 minutes, there is a bus going to the city centre of Antwerp, so real co-ordination (of timetables etc.) is unnecessary. Therefore co-operation between the airport management and the bus company (“De Lijn”) is non-existent. The only two stakeholders, that do cooperate to make Antwerp Airport more attractive, are the airport management and the carrier CityJet. Spokespersons of the two companies were asked to participate in an in-depth, face to face interview. The fact that they were able to give open answers and that the interviewer could ask further questions, contributed to outlining a complete picture.

The answers given in these interviews, were completed by the responses obtained in earlier discussions, held in light of WP3 and 4. Back then, conversations were held with public decision makers, the airport commander, the CEO of the carrier CityJet. Recently, interviews were held with Katleen Pittevils, responsible for the communication at Antwerp Airport, and Catherine Stuyck, marketing and communications manager of CityJet.

6.7.3 Stakeholders/Agents at the site

Many players are active at Antwerp Airport, but as already stated, there are only two stakeholders¹⁰ that co-operate to make Antwerp Airport more attractive: the airport management and the carrier CityJet. These two stakeholders obviously do not offer intermodal services; they only co-operate to offer the traveller an air transport connection.

Concerning intermodality, there is no co-operation: the bus company is an independent party, offering services to the travellers separately from the services offered at Antwerp Airport. Since there is a bus every 15 min., travellers do not have to wait too long, so co-ordination of timetables is not necessary. Also the taxi companies do not tune their services to the services offered at the airport.

Looking at this in terms of agents, one can see that there are currently five agents, directly related with the airport, can be listed. The first agent is the passenger who is requesting services from the second agent, the airline. These services are delivered at the interchange, the airport. Other transport modes, available to access the airport, are bus, taxi and rental cars. The companies responsible for these services form the remaining three agents.

To travel further, the passenger can also use the train. However, to get to the train station, he has to take the bus first because this provider of public transport is not located at the airport.

Next to those agents, there are indirect agents: the passenger can be picked up from the airport by a (private) driver, or can use his own car to travel to his destination. Here, there are interactions, but those are private and thus not commercial.

6.7.3.1 Objectives and Goals

The first agent mentioned, is the passenger. His objective is to get from the airport to his final destination in a short amount of time, at a low cost. Since Antwerp Airport mainly serves business travellers, the passengers are more time-sensitive than cost-sensitive. This results in the use of the quickest and best available transport modes; being the own car and taxi. The small

¹⁰ Next to the airport management and the carrier CityJet, there are also other stakeholders that want and try to offer the customer a satisfying airport experience, for example the security staff, the personnel of the airport shop, ... However, they are not cooperating in making the airport more accessible or they do not contribute to the intermodality/interconnectivity and are thus not mentioned here.

amount of leisure travellers passing through Antwerp Airport, is more cost-sensitive and will use the bus to access and leave the airport site.

The other (directly related) agents all try to maximize their revenue and thus profit. The airport management, however also tries to maximize its accessibility.

6.7.3.2 *Strategies*

Business travellers plan their trip beforehand and thus know precisely at which location they have to be at which time. Using internet and other media, the passenger can plan his / her journey by looking at the modes that travel the quickest to their destination. Furthermore, the business traveller likes to arrive as close to the final destination as possible. Taking these two factors into account, using the own car, renting a car or taking a taxi seems the best option since those modes are directly available at the airport and are able to drop off the passenger where he/she has to be¹¹.

Leisure travellers are more cost sensitive and will try to find out beforehand which mode is the cheapest to get to their destination. Looking at the modes available at Antwerp Airport, one might assume that the bus is the mode with the lowest cost. The leisure traveller can find this information in advance through the internet or on the spot by looking at brochures, leaflets, etc.

Transport companies (bus, taxi, car rental and train) try to maximise their revenue by attracting as much customers as possible. They can do so by setting up a good marketing campaign which helps the traveller to find the necessary information (e.g. online, at the airport website) beforehand. Furthermore, the companies can invest in their visibility so that they stand out when travellers exit the airport building.

The main goal of the airport management is making the airport well accessible. They can do so by co-operating with the transport providers present at the site. Currently, there is no interaction with other transport providers. Negotiations and co-operation might be an option for the future.

¹¹ The passenger has to wait for the bus to come and can only get off at a bus stop near his / her destination, but most likely not at his destination. Therefore, the passenger has to walk or transfer to another mode. The same goes for the train.

6.7.3.3 Interactions between agents

In Figure 6.301, the interaction between the different agents currently operating is described.

Agents	Passenger	Airline	Airport (management)	Bus company	Taxi company	Car rental company	Train company
Passenger	No interaction	Commercial	Commercial	Commercial	Commercial	Commercial	Commercial
Airline	Commercial	(Only one airline present)	Cooperation/contractual	No interaction	No interaction	No interaction	No interaction
Airport (management)	Commercial	Cooperation/contractual	/	No interaction (so far)	No interaction (so far)	No interaction (so far)	No interaction (so far)
Bus company	Commercial	No interaction	No interaction (so far)	(Only one bus company present)	Competition	Competition	Train depending on bus to deliver passengers
Taxi company	Commercial	No interaction	No interaction (so far)	Competition	Competition in between taxi companies	Competition	Indirect Competition
Car rental company	Commercial	No interaction	No interaction (so far)	Competition	Competition	Competition in between car rental companies	Indirect Competition
Train company	Commercial	No interaction	No interaction (so far)	Train depending on bus to deliver passengers	Indirect Competition	Indirect Competition	(Only one train company present)

Figure 6.301: Interactions between the different agents at Antwerp Airport Source: own composition

6.7.3.4 Graphical representation

Figure 6.302 gives a graphical representation of the agents currently operating at (or indirectly related to) Antwerp Airport.

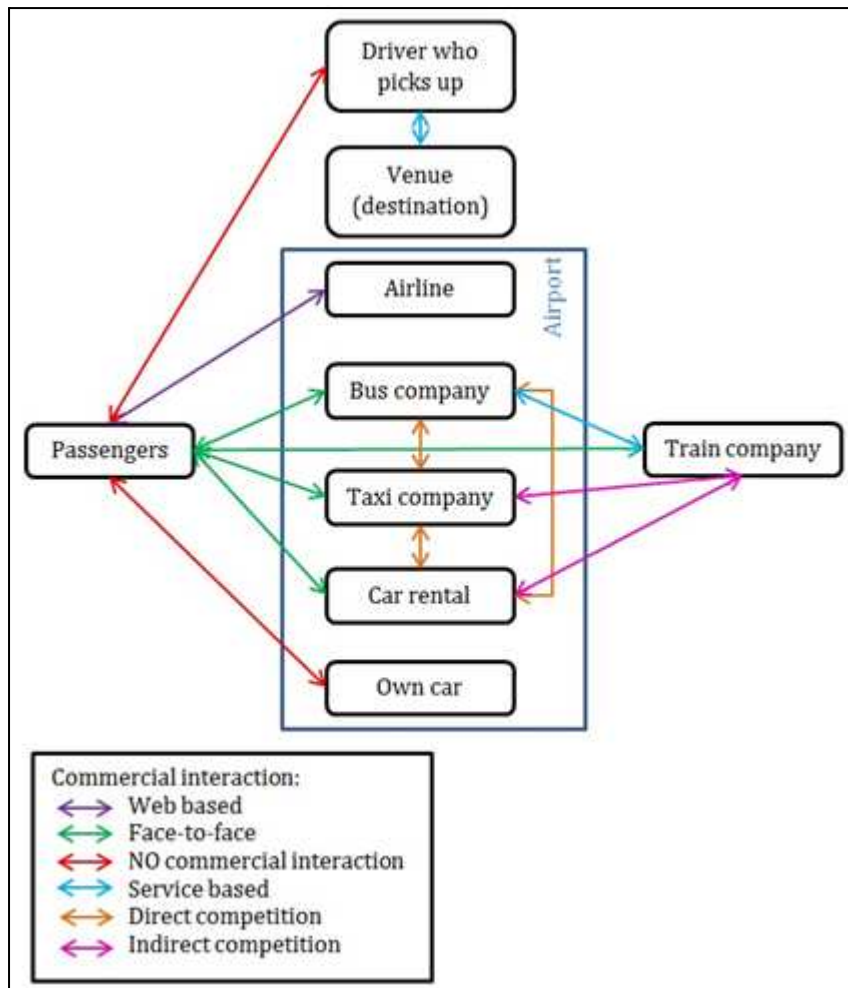


Figure 6.302: ABM conceptual presentation of the current Business Model Source: Own composition

6.7.4 Current short-long interconnectivity problems/opportunities

The only problem and opportunity at Antwerp Airport (concerning interconnectivity), is that there is no direct train connection. However, the rail tracks run next to the site of Antwerp Airport, as can be seen on Figure 6.303.

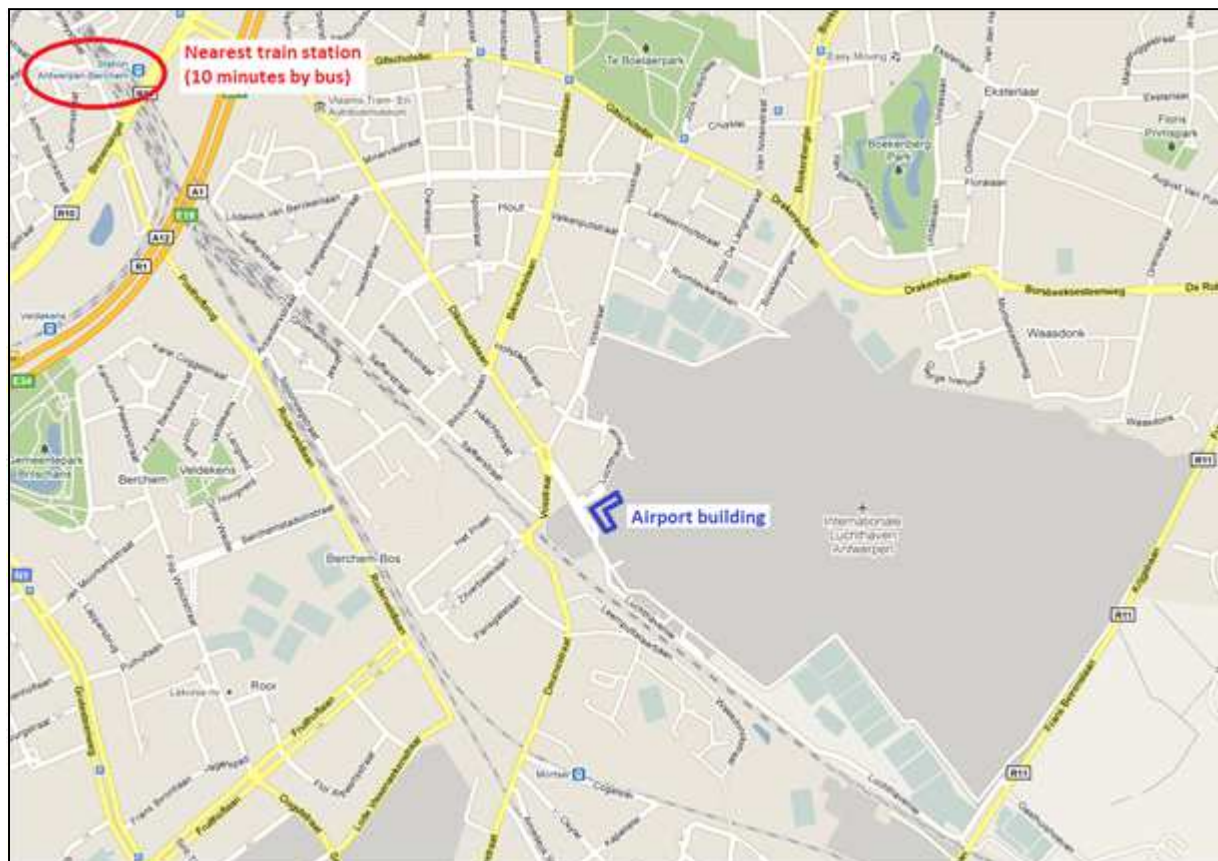


Figure 6.303: Map of Antwerp Airport, with indication of rail connection. Source: Own composition, based on existing map (Google Maps)

Co-operation with the company that offers national rail services (NMBS) could contribute to a better train connection for Antwerp Airport. Making Antwerp Airport directly accessible by train, would probably imply a modal shift for some of the existing customers (from car to train) and would attract more leisure travellers. The management of Antwerp Airport is very much aware of that and approached the NMBS with this thought. However, since the number of passengers that use the train to go to the airport is now very low, the railway company does not want to finance the construction of a new train station.

This is obviously a vicious circle: as long as there are not enough people using the train to get to the airport, the train station will not be constructed; but to get enough people to access the airport by train, there needs to be a train station next to the airport.

6.7.5 Current value proposition

For business travellers, time is money. Antwerp Airport tries to take this to its advantage by offering a unique service with their 20 min. check-in. The fact that the airport is rather small, makes that the walking distances are relatively short which adds to the time saving effect. Antwerp Airport also distinguishes itself from other airports by offering a free car parking lot (and most business travellers come by car or taxi, rarely by train or bus).

6.7.6 Description of current business model

The aim of the interviews with the two stakeholders mentioned before (airport management and carrier CityJet), was to get a clear view on the business model. Using documents such as brochures, annual reports, ... a business model was set out. The interviews were needed to check whether the encountered business model was correct. After talking with Kathleen Pittevels (communications manager of Antwerp Airport) and Catherine Stuyck (marketing and communications manager of CityJet), the business model found through literature was confirmed. Since there are two main stakeholders, working together to offer the travellers a good air transport service, the business model (and value proposition) of Antwerp Airport is built upon the characteristics of both stakeholders.

According to Osterwalder (2004), there are nine building blocks: Customer Segments (CS), Value Propositions (VP), Channels (CH), Customer Relationships (CR), Revenue Streams (R\$), Key Resources (KR), Key Activities (KA), Key Partnerships (KP) and Cost Structure (C\$).

6.7.6.1 Customer Segments (CS)

In this section, the Customer Segments (CS) are described by answering the following questions:

- How many passengers per day? And per year?
- What is the gender percentage?
- What is the passenger percentage between 15-20 years old, 21-35, 36-55, 56-64 and more than 65 years?
- What is the passenger percentage with reduced mobility?
- What are passengers' most common destinations?
- What is passengers' travel purpose?
- What class do passengers choose to travel?

Antwerp Airport mainly serves business people. Therefore, about 80% of the passengers is male and 60% of the passengers is middle-aged (36-55). However, since the main airline CityJet (formerly VLM) joined the Air France-KLM group, the prices have lowered and more leisure travellers are attracted. This number does not outweigh the number of business travellers.

CityJet offers 2 destinations at Antwerp Airport: London City and Manchester. Most of the flights depart at weekdays. There are 5 departing flights to London City a day and only 2 flights to Manchester.

CityJet, the carrier at Antwerp Airport, offers two different travel classes: CityValue (“economy class”) and CityPlus (“business class”). The majority of the passengers (more than 90%) opts for CityValue.

6.7.6.2 Value Proposition (VP)

In this section, the Value Proposition (VP) is described by answering the following questions:

- What kind of transport services does the company offer (e.g. short/long distance, types of transport, etc)?
- What are the different services provided by the company (e.g. combination with other transport modes, ticket for O/D or ticket for service, etc)?
- Do transport services present different travel classes?
- Does the provided service allow utilization by people with reduced mobility?
- What are the main reasons for passengers to choose this company over another?
- What are the company’s service levels (e.g. reliability, punctuality, etc)?

The airport itself has three main tasks: they provide the infrastructure, they are responsible for safety and security and they are in charge of the commercial exploitation (i.e. attracting airlines).

The present carrier (CityJet) provides air transport for the passengers.

As already mentioned, there are two different travel classes. The people travelling in business class, are the people who choose for CityPlus. The advantage of CityPlus is that the tickets are very flexible and can be changed at all times without extra costs. Furthermore, these passengers are offered a drink and they get a more elaborate meal.

At Antwerp Airport, a limited amount of other services are available. In the airport building, there are some companies such as a bank, a shop, a restaurant and car rental companies. However, these shops are concessionaires and thus are independent from the airport itself.

Furthermore, there is a business lounge of which the airlines and tour operators can distribute entrance tickets. However, this business lounge is not often used because the waiting times at Antwerp Airport are rather limited. Only when a plane is chartered or in case of delays, the business lounge is used. Also passengers from tour operator JetAir use the business lounge, because Antwerp Airport has an agreement with JetAir that if passengers fly to London through a JetAir-booking, the entrance to the business lounge is included in the ticket price. In return, Antwerp Airport is mentioned in the JetAir-catalogue.

Antwerp Airport offers a couple of advantages compared to other (Belgian) airports. First of all, there is a 20 min.' check-in concept. The passengers can check in an hour in advance up to 20 minutes before take-off. This way, travellers can save a lot of time. Furthermore, there is a large parking area available very close to the airport entrance and this is for free.

The level of service at Antwerp Airport is rather high. For example, Antwerp Airport was open all winter, despite the harsh weather. Any possible delays are due to the airline and are not that common. If there would be a delay, this would not affect other flights since there are no slots at Antwerp Airport.

Until 2009, passenger satisfaction was measured every year and these surveys were quite elaborate. The results show that almost 100% of the passengers were very satisfied with the service provided by CityJet and with the service provided at Antwerp Airport.

6.7.6.3 Channels (CH)

In this section the Channels (CH) were described by answering the following questions:

- What are the channels that the company uses to spread information (e.g. website, displays on platforms, etc)?
- How does the company raise awareness (e.g.: advertisement, etc) about its services?
- How does the company sell tickets?
- Does the company provide any after-sales customer support?

Antwerp Airport provides customers with information through different channels. The website contains all the information about the airport. Displays at the terminal and TeleText keep passengers up to date about the departing and arriving flights. Furthermore, a newsletter is distributed via e-mail to provide stakeholders with the latest news. Some more general articles and information also appear in magazines which are issued by the Antwerp Chamber of Commerce¹².

The carrier CityJet, the airline serving Antwerp Airport, provides also some information through their website, in their inflight magazine, in an e-newsletter and through flyers and other brochures.

¹² Authority which represents the interests of Belgian companies in a certain region.

CityJet has some advertising campaigns in specialized magazines, B2B magazines and some business-oriented newspapers. The advertising campaigns are rather limited due to the limited number of destinations. If Antwerp Airport would launch a large campaign, potential customers might be disappointed if they discover that they can only fly to London City or Manchester. However, if another destination would be offered in the future, the airport would try to advertise as much as possible.

In the past, CityJet also offered flights to Frankfurt, but due to little promotion (amongst others) the destination was cancelled already three months later.

Tickets to London City and Manchester can be bought through the different channels of CityJet: website, ticket desks and travel agencies. Furthermore, it is also possible to buy tickets at the airport, at the ticket desk of CityJet.

For after-sales services, CityJet has a callcenter and a customer service department. Their policy is to respond to complaints and praises within 24h and to solve problems within a week.

6.7.6.4 *Customer Relationships (CR)*

In this section, the Customer Relationships (CR) are described by answering the following questions:

- How does the customer interact with the company?
 - Is there a fidelity program (e.g. frequent flyer, etc)?
 - Does the company have information desks?
 - Are employees or machines used to sell tickets?

The interaction with the customers is decreasing the last few years. For example, nowadays boarding passes can be printed at home. Since the merger with Air France-KLM, CityJet has some fidelity programs and this provides the airport with other customers: more and more French-speaking passengers pass through Antwerp Airport.

The airport has little interaction with the customers. CityJet assesses the satisfaction from their passengers from time to time, but prefers that the airport itself does not bother the travellers.

This is one of the downsides of having only one carrier: the carrier has a lot of power.

6.7.6.5 Revenue Streams (R\$)

In this section, the Revenue Streams (R\$) are described by answering the following questions:

- What are the revenue sources (e.g.: tickets, advertisement, retail)?
- If there are other revenue sources, what share do they represent?
- What is the ticketing scheme?
- Does the company have a revenue management system?

The main source of revenue comes from the government: Antwerp Airport receives an endowment from the Flemish Region. Furthermore, the concession fees from the companies with buildings on the airport grounds and the retail in the airport building provide the airport with some income. A small part of the total revenue also comes from rent they extract from companies renting offices in the airport building. Advertising revenue is relatively low.

The revenues from CityJet come from ticket sale. They also have a charter department where companies can charter a plane, crew included, for a certain amount of time. Other revenues come from advertisements in their inflight magazine.

6.7.6.6 Key Resources (KR)

In this section the Key Resources (KR) are described by answering the following questions:

- What are the company's financial resources?
- What kind of human resources does the company have?
- What are the company's physical resources:
 - Fleet
 - Infrastructure (e.g. tracks, terminals, etc)
 - Slots (e.g. air, rail, etc)
- What are the company's R&D activities (e.g. patents, databases, etc)?

About 70 people (FTE) are employed directly at the airport. Next to that, Belgocontrol¹³ employs about 20 people, the Federal police employs about 14 people and 13 people work with the customs at the airport. Furthermore, the airport grounds hold about 60 companies that employ about 500 people. This adds up to an airport with about 600 people as human resources.

The infrastructure belonging to the airport consists of the airport building, a hangar, the runway and taxiways and the large parking lot.

CityJet does not perform real R&D activities, but they are in constant search of new potential routes.

6.7.6.7 Key Activities (KA)

In this section, the Key Activities (KA) are described by answering the following questions:

¹³ Belgocontrol is an autonomous public company in charge of the safety of air traffic in the civil airspace for which the Belgian State is responsible

- What are the main activities in the platform/network sector?
What are the company's markets (e.g. regions, long/short distance)?
- Is the company involved in other activities besides transport?

The airport is responsible for the infrastructure, the safety and security at the airport and the commercial exploitation of the airport. The airport does not provide ground handling services. A separate company, Flying Group, performs ground handling services and CityJet is also a self-handler.

6.7.6.8 Key Partnerships (KP)

In this section, the Key Partnerships (KP) are described by answering the following questions:

- Does the company have partners? What sort of partners?
 - Agreements with other transport related companies
 - Agreements with other companies (e.g. insurance companies, hotels, etc)
- What kind of agreements does the company have with its partners (e.g. advertising, revenue share, etc)?

Antwerp Airport is a part of the Flemish Government. Other than that, there are no partnerships. The only co-operation there is, is in the form of concessions (e.g. restaurant, shop).

So far, there has been no attempt to improve intermodality through close co-operation with other transport providers.

CityJet has some partnerships which are based on "trading goods". For example, they have an agreement with the Zoo of Antwerp where they import the eucalyptus leaves for the koala bears and get some free entrance tickets for their personnel in exchange. Some of their passengers are allowed in the membership club of the "Gerkhin" in London. Normally this is impossible, but thanks to the CityPlus, the business travellers are granted access and that way the club gets known amongst a larger audience.

In the future, CityJet wants to enter into a partnership with some A-brands such as Samonite and an automobile manufacturer. These partnerships would be paid by advertisements.

6.7.6.9 Cost Structure (C\$)

In this section the Cost Structure (C\$) is described by answering the following questions:

- Is the company's cost structure based on minimizing cost for the passengers or focused on value creation (maximising revenue)?
- What kind of economies does the company have (e.g.: scale, density and scope)?

Antwerp Airport receives an endowment for the exploitation and for investments. Both amounts barely cover the costs. Next to those external revenues, the airport has some income of its own, but this is limited.

Safety and security represent the biggest cost: next to personnel, the equipment needed is quite expensive. This equipment needs to be purchased by every airport, but the costs of it are (relatively) much higher for small airports.

Antwerp Airport tries to achieve some economies of scale and/or scope through co-operation with the Airport of Ostend, but this effort has decreased over the last years.

The cost structure of CityJet is based on revenue management: for example, the first 50 seats are sold at a given price, but the next 50 might be for a lower price or a higher price. Here, they also take the competitors into account. If, for example, Eurostar is on a strike, the prices of CityJet will rise.

6.7.7 Current level of quality of services and customer satisfaction

In this chapter, the passengers' satisfaction of quality of services at Antwerp Airport will be described, by combining findings from observations and a customer survey. In every paragraph, the current situation is described, using data from observation. Then, passenger satisfaction is expressed through the results of the passenger survey. The results are somewhat different for the passengers travelling during peak or non-peak hours¹⁴. Therefore, a distinction between these two categories is made.

6.7.7.1 Description general information about the passenger

Figure 6.304 shows that Antwerp Airport is a business airport, meaning that most of the travellers (86%) are business travellers. Antwerp Airport has a specific value proposition, designed for its customer segment, the business traveller: it is a small airport, with a 20 min.' check-in concept and a lot of free parking space in front of the airport building. Thanks to the rather short walking distances and the 20 min.' check-in, the passenger can save time and this is important for business travellers. Furthermore, most of the business travellers come to Antwerp Airport using their own car (32 of the 43 respondents) or taxi (10 of the 43 respondents). Public transport is underrepresented at the airport, but is not necessary due to the targeted audience¹⁵.

¹⁴ The number of non-peak travellers is much lower than the number of peak-travellers, because of the business character of Antwerp Airport: in the morning, most business travellers fly off to London to go to work. During the day, the number of travellers going through Antwerp Airport is much lower.

¹⁵ The only passenger using public transport (bus) is a non-peak passenger, travelling for other purposes.

Purpose of trip	Access mode	Number during peak hours	Number during non-peak hours	TOTAL (per row)	Percentage
Business		28	9	37	86,1%
	<i>Own car</i>	22	8	30	
	<i>Taxi</i>	6	1	7	
Private		4	0	4	9,3%
	<i>Own car</i>	1	/	1	
	<i>Taxi</i>	3	/	3	
Leisure		1	0	1	2,3%
	<i>Own car</i>		/	1	
Other		0	1	1	2,3%
	<i>Bus</i>	0	1	1	
TOTAL				43	100%

Figure 6.304: Purpose of the trip and access mode to the airport, peak and non-peak

Source: Own composition, based on responses to questions 4 and 5 of the Customer survey WP5, version Antwerp Airport

Category		Number	TOTAL	Percentage
Not familiar at all	Peak	4	8	19%
	Non-peak	4		
Somewhat familiar	Peak	2	4	9%
	Non-peak	2		
Quite familiar	Peak	11	13	30%
	Non-peak	2		
Very familiar	Peak	16	18	42%
	Non-peak	2		
TOTAL			43	100%

Figure 6.305: Frequency of visits to Antwerp Airport by the respondents

Source: Own composition, based on responses to question 15 of the Customer survey WP5, version Antwerp Airport

Figure 6.305 shows that most of the respondents frequently visit Antwerp Airport. Therefore, they are familiar with the airport.

Overall, the survey conducted at Antwerp Airport lead to 43 responses. This is rather low, but due to the business character of the airport, travellers do not want to co-operate easily. Moreover, most of the responses are the same. Conducting more surveys would thus be difficult and would not alter the results of the survey. Given the difficulties to find respondents and the fact that most passengers come by car, the majority of the travellers are not willing to respond to the survey when arriving at the airport. Finding respondents waiting at the gate to travel to London was much more easy, so, at Antwerp Airport, the responses are limited to departing passengers.

Figure 6.306 states that a slight majority of travellers are men. Most of the respondents are between 21 and 55 years old.

Gender		Age category				TOTAL (per row)	%
		15-20	21-35	36-55	56-64		
Men	Peak	0	3	12	3	18	56%
	Non-peak	0	3	3	0	6	
Women	Peak	1	4	9	1	15	44%
	Non-peak	0	2	2	0	4	
TOTAL		1	12	26	4	43	

Figure 6.306: Distribution of responses according to gender and age, during peak and non-peak
Source: Own composition, based on responses to questions 1 and 2 of the Customer survey WP5, version Antwerp Airport

Based on question 3¹⁶ of the Customer survey, Figure 6.307 shows a map of Belgium and The Netherlands. The numbers in purple show the number of peak hour travellers that come from each province, the numbers in orange show how many passengers are travelling during non-peak hours, and which province they come from. During non-peak hours, the distance travelled is not larger than during peak hours. One would expect that, since traffic is more dense during peak hours and people would tend to avoid that.

¹⁶ What is the origin of your journey today?



Figure 6.307: Map of Belgium and The Netherlands, showing the origin of respondents

Source: Own composition, based on the responses to question 3 of the Customer survey WP5, version Antwerp Airport

The figures below give a hint from where the passengers come and how long they travelled to get to Antwerp Airport. Almost half of the respondents come from within the province of Antwerp. The provinces of Flemish Brabant and of East Flanders and The Netherlands are adjacent to the province of Antwerp. Almost 33% of the respondents come from those origins. As expected, little travellers come from origins further away from Antwerp Airport. Quite an amount of passengers comes from an unknown origin. **Error! Reference source not found.** shows how long they travelled to get to Antwerp Airport. This way, the distance travelled can be more or less deducted by comparing the travel time to the other responses.

Figure 110 shows that most passengers travel maximum 30 minutes to the airport, but there are still a lot of passengers travelling up to an hour, or some even more than an hour to get to Antwerp Airport.

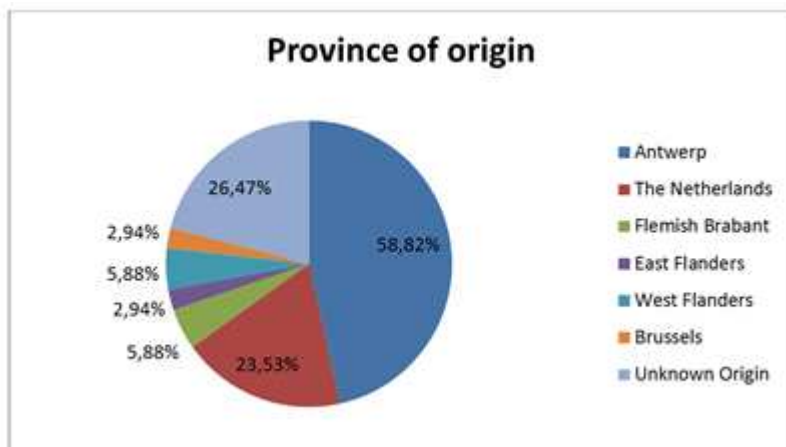


Figure 6.308 Distribution of provinces of origin of respondents

Source: Own composition, based on the responses to question 3 of the Customer survey WP5, version Antwerp Airport



Figure 6.309 Distribution of travel time of the trip to Antwerp Airport

Source: Own composition, based on the responses to question 3 of the Customer survey WP5, version Antwerp Airport

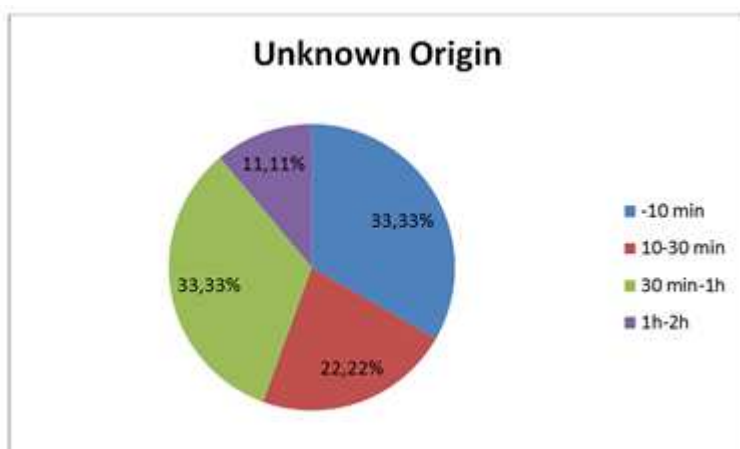


Figure 6.310 Distribution of travel time of passengers coming from an unknown origin

Source: Own composition, based on the responses to question 3 of the Customer survey WP5, version Antwerp Airport

Given the fact that only departing passengers were questioned, responses to questions 7¹⁷, 8¹⁸ and 9¹⁹ were the same for all the travellers: they all used the airplane to travel from the airport and since their destination was London, they travelled for 1 to 2 hours (and between 100 and 700 kilometers). The main mode of the trip is then the airplane.

6.7.7.2 *Travel demand/Passenger flow*

The data in the following chapter will describe whether services provided at the site are proportional to the passenger flow. The data used here, were all gathered on the first day of the work week and a distinction between peak hours (6h – 11u) and non-peak hours (13h – 20h) is made. The data concern the high season, since they are gathered during the month of May. Given the fact that Antwerp Airport is a business airport, the months of July and August are low season. During these months, the frequency of flights drops.

6.7.7.2.1 Observation

At Antwerp Airport, there are little connections to public transport. There is only a bus stop is near the airport building. Given the fact that most passengers are business travellers and that they come by car or taxi, most of the respondents do not have any experience using public transport. Therefore, they do not have to take into account possible co-ordination of timetables, travel connections and combinations of different modes. For their access mode (car or taxi), the airport is very well accessible: there is a large, free parking lot right in front of the airport building. What the business passengers do have to take into account, is the waiting time. For business people, time is money, so the airport wants to offer their customers a 20 min.' check-in. Thanks to this short waiting time, the airport is not in need of a lot of retail or entertainment. There is only one (small) airport shop present which sells magazines and newspapers, some drinks, cigarettes, etc.

¹⁷ What is the first transport mode you will use to travel from this airport today?

¹⁸ How long is your trip departing from this airport?

¹⁹ Which main mode of transport will you use for your total trip today?

6.7.7.2.2 Passenger satisfaction - Survey

During peak hours													
<p>Coordination of timetables (men-peak)</p> <table border="1"> <caption>Men-peak satisfaction data</caption> <thead> <tr> <th>Satisfaction Level</th> <th>Percentage</th> </tr> </thead> <tbody> <tr> <td>very satisfied</td> <td>83,33%</td> </tr> <tr> <td>quite satisfied</td> <td>16,67%</td> </tr> <tr> <td>neither satisfied or dissatisfied</td> <td>0%</td> </tr> <tr> <td>quite dissatisfied</td> <td>0%</td> </tr> <tr> <td>very dissatisfied</td> <td>0%</td> </tr> </tbody> </table>	Satisfaction Level	Percentage	very satisfied	83,33%	quite satisfied	16,67%	neither satisfied or dissatisfied	0%	quite dissatisfied	0%	very dissatisfied	0%	
Satisfaction Level	Percentage												
very satisfied	83,33%												
quite satisfied	16,67%												
neither satisfied or dissatisfied	0%												
quite dissatisfied	0%												
very dissatisfied	0%												
<p>Coordination of timetables (women-peak)</p> <table border="1"> <caption>Women-peak satisfaction data</caption> <thead> <tr> <th>Satisfaction Level</th> <th>Percentage</th> </tr> </thead> <tbody> <tr> <td>very satisfied</td> <td>60,00%</td> </tr> <tr> <td>quite satisfied</td> <td>26,67%</td> </tr> <tr> <td>do not know</td> <td>6,67%</td> </tr> <tr> <td>quite dissatisfied</td> <td>6,67%</td> </tr> <tr> <td>very dissatisfied</td> <td>0%</td> </tr> </tbody> </table>	Satisfaction Level	Percentage	very satisfied	60,00%	quite satisfied	26,67%	do not know	6,67%	quite dissatisfied	6,67%	very dissatisfied	0%	
Satisfaction Level	Percentage												
very satisfied	60,00%												
quite satisfied	26,67%												
do not know	6,67%												
quite dissatisfied	6,67%												
very dissatisfied	0%												

In the figures the satisfaction concerned the coordination of the timetables can be seen. All of the men and most of the women are quite to very satisfied. Some women responded that they do not know, probably because they never had any experience with having to transfer between modes with timetables at Antwerp Airport.

Figure 6.311 & Figure 6.312 Satisfaction of men and women with the coordination of the timetables (during peak hours)

Source: Own composition, based on the responses to question 10 of the Customer survey WP5, version Antwerp Airport

During non-peak hours															
<p>Coordination of timetables (men-non-peak)</p> <table border="1"> <caption>Men-non-peak satisfaction data</caption> <thead> <tr> <th>Satisfaction Level</th> <th>Percentage</th> </tr> </thead> <tbody> <tr> <td>very satisfied</td> <td>33,33%</td> </tr> <tr> <td>quite satisfied</td> <td>33,33%</td> </tr> <tr> <td>do not know</td> <td>33,33%</td> </tr> <tr> <td>neither satisfied or dissatisfied</td> <td>0%</td> </tr> <tr> <td>quite dissatisfied</td> <td>0%</td> </tr> <tr> <td>very dissatisfied</td> <td>0%</td> </tr> </tbody> </table>	Satisfaction Level	Percentage	very satisfied	33,33%	quite satisfied	33,33%	do not know	33,33%	neither satisfied or dissatisfied	0%	quite dissatisfied	0%	very dissatisfied	0%	
Satisfaction Level	Percentage														
very satisfied	33,33%														
quite satisfied	33,33%														
do not know	33,33%														
neither satisfied or dissatisfied	0%														
quite dissatisfied	0%														
very dissatisfied	0%														
<p>Coordination of timetables (women-non-peak)</p> <table border="1"> <caption>Women-non-peak satisfaction data</caption> <thead> <tr> <th>Satisfaction Level</th> <th>Percentage</th> </tr> </thead> <tbody> <tr> <td>very satisfied</td> <td>100,00%</td> </tr> <tr> <td>quite satisfied</td> <td>0%</td> </tr> <tr> <td>neither satisfied or dissatisfied</td> <td>0%</td> </tr> <tr> <td>quite dissatisfied</td> <td>0%</td> </tr> <tr> <td>very dissatisfied</td> <td>0%</td> </tr> </tbody> </table>	Satisfaction Level	Percentage	very satisfied	100,00%	quite satisfied	0%	neither satisfied or dissatisfied	0%	quite dissatisfied	0%	very dissatisfied	0%			
Satisfaction Level	Percentage														
very satisfied	100,00%														
quite satisfied	0%														
neither satisfied or dissatisfied	0%														
quite dissatisfied	0%														
very dissatisfied	0%														

The figures show the satisfaction concerning the time-tables during non-peak hours. The majority of men and all of the women are quite to very satisfied. Some men have no experience with the coordination of timetables, probably because during non-peak hours even more passengers come by car instead of public transport (thanks to the quietness on the roads).

Figure 6.313 & Figure 6.314: Satisfaction of men and women with the coordination of the timetables (during non-peak hours) Source: Own composition, based on the responses to question 10 of the Customer survey WP5, version Antwerp Airport

During peak hours																
<p>Possible travel connections (men-peak)</p> <table border="1"> <caption>Possible travel connections (men-peak)</caption> <thead> <tr> <th>Satisfaction Level</th> <th>Percentage</th> </tr> </thead> <tbody> <tr> <td>very dissatisfied</td> <td>0%</td> </tr> <tr> <td>quite dissatisfied</td> <td>0%</td> </tr> <tr> <td>neither satisfied or dissatisfied</td> <td>0%</td> </tr> <tr> <td>quite satisfied</td> <td>11,11%</td> </tr> <tr> <td>very satisfied</td> <td>77,78%</td> </tr> <tr> <td>do not know</td> <td>11,11%</td> </tr> </tbody> </table>	Satisfaction Level	Percentage	very dissatisfied	0%	quite dissatisfied	0%	neither satisfied or dissatisfied	0%	quite satisfied	11,11%	very satisfied	77,78%	do not know	11,11%		<p>The majority of the men and women are (during peak hours) quite to very satisfied with the possible travel connections. Antwerp Airport only connects London or Manchester directly to Antwerp. This is rather limited, but business travellers commuting to London at peak hours, do not expect more. They know in advance that those are the only options, and they probably only need that connection.</p> <p>Striking is the fact that more women are dissatisfied with the travel connections: they would like to be offered more connections.</p>
Satisfaction Level	Percentage															
very dissatisfied	0%															
quite dissatisfied	0%															
neither satisfied or dissatisfied	0%															
quite satisfied	11,11%															
very satisfied	77,78%															
do not know	11,11%															
<p>Possible travel connections (women-peak)</p> <table border="1"> <caption>Possible travel connections (women-peak)</caption> <thead> <tr> <th>Satisfaction Level</th> <th>Percentage</th> </tr> </thead> <tbody> <tr> <td>very dissatisfied</td> <td>0%</td> </tr> <tr> <td>quite dissatisfied</td> <td>20,00%</td> </tr> <tr> <td>neither satisfied or dissatisfied</td> <td>0%</td> </tr> <tr> <td>quite satisfied</td> <td>33,33%</td> </tr> <tr> <td>very satisfied</td> <td>33,33%</td> </tr> <tr> <td>do not know</td> <td>13,33%</td> </tr> </tbody> </table>	Satisfaction Level	Percentage	very dissatisfied	0%	quite dissatisfied	20,00%	neither satisfied or dissatisfied	0%	quite satisfied	33,33%	very satisfied	33,33%	do not know	13,33%		
Satisfaction Level	Percentage															
very dissatisfied	0%															
quite dissatisfied	20,00%															
neither satisfied or dissatisfied	0%															
quite satisfied	33,33%															
very satisfied	33,33%															
do not know	13,33%															

Figure 6.315 & Figure 6.316 Satisfaction of men and women with the possible travel connections (during peak hours) Source: Own composition, based on the responses to question 10 of the Customer survey WP5, version Antwerp Airport

During non-peak hours																
<p>Possible travel connections (men-non-peak)</p> <table border="1"> <caption>Possible travel connections (men-non-peak)</caption> <thead> <tr> <th>Satisfaction Level</th> <th>Percentage</th> </tr> </thead> <tbody> <tr> <td>very dissatisfied</td> <td>0%</td> </tr> <tr> <td>quite dissatisfied</td> <td>16,67%</td> </tr> <tr> <td>neither satisfied or dissatisfied</td> <td>16,67%</td> </tr> <tr> <td>quite satisfied</td> <td>0%</td> </tr> <tr> <td>very satisfied</td> <td>33,33%</td> </tr> <tr> <td>do not know</td> <td>33,33%</td> </tr> </tbody> </table>	Satisfaction Level	Percentage	very dissatisfied	0%	quite dissatisfied	16,67%	neither satisfied or dissatisfied	16,67%	quite satisfied	0%	very satisfied	33,33%	do not know	33,33%		<p>During non-peak hours, all of the women, but only 33% of the male respondents are very satisfied. During non-peak hours, there is a smaller group that is commuting; the business travellers also travel to London, but might want to have other travel options.</p> <p>During non-peak hours, more men want to be offered other travel connections.</p>
Satisfaction Level	Percentage															
very dissatisfied	0%															
quite dissatisfied	16,67%															
neither satisfied or dissatisfied	16,67%															
quite satisfied	0%															
very satisfied	33,33%															
do not know	33,33%															
<p>Possible travel connections (women-non-peak)</p> <table border="1"> <caption>Possible travel connections (women-non-peak)</caption> <thead> <tr> <th>Satisfaction Level</th> <th>Percentage</th> </tr> </thead> <tbody> <tr> <td>very dissatisfied</td> <td>0%</td> </tr> <tr> <td>quite dissatisfied</td> <td>0%</td> </tr> <tr> <td>neither satisfied or dissatisfied</td> <td>0%</td> </tr> <tr> <td>quite satisfied</td> <td>0%</td> </tr> <tr> <td>very satisfied</td> <td>100,00%</td> </tr> </tbody> </table>	Satisfaction Level	Percentage	very dissatisfied	0%	quite dissatisfied	0%	neither satisfied or dissatisfied	0%	quite satisfied	0%	very satisfied	100,00%				
Satisfaction Level	Percentage															
very dissatisfied	0%															
quite dissatisfied	0%															
neither satisfied or dissatisfied	0%															
quite satisfied	0%															
very satisfied	100,00%															

Figure 6.317 & Figure 6.318 Satisfaction of men and women with the possible travel connections (during non-peak hours) Source: Own composition, based on the responses to question 10 of the Customer survey WP5, version Antwerp Airport

During peak hours																
<p>Possibility to combine different modes (men-peak)</p> <table border="1"> <caption>Satisfaction levels for men during peak hours</caption> <thead> <tr> <th>Satisfaction Level</th> <th>Percentage</th> </tr> </thead> <tbody> <tr> <td>very dissatisfied</td> <td>0%</td> </tr> <tr> <td>quite dissatisfied</td> <td>0%</td> </tr> <tr> <td>neither satisfied or dissatisfied</td> <td>5,56%</td> </tr> <tr> <td>quite satisfied</td> <td>22,22%</td> </tr> <tr> <td>very satisfied</td> <td>61,11%</td> </tr> <tr> <td>do not know</td> <td>11,11%</td> </tr> </tbody> </table>	Satisfaction Level	Percentage	very dissatisfied	0%	quite dissatisfied	0%	neither satisfied or dissatisfied	5,56%	quite satisfied	22,22%	very satisfied	61,11%	do not know	11,11%		<p>Antwerp Airport is only (but well) accessible through road modes (car, taxi, bus). A train stop is nearby, but to get to Antwerp Airport, the train traveller also has to take the bus. Nevertheless, most respondents are quite to very satisfied with the possibilities to combine modes.</p>
Satisfaction Level	Percentage															
very dissatisfied	0%															
quite dissatisfied	0%															
neither satisfied or dissatisfied	5,56%															
quite satisfied	22,22%															
very satisfied	61,11%															
do not know	11,11%															
<p>Possibility to combine different modes (women-peak)</p> <table border="1"> <caption>Satisfaction levels for women during peak hours</caption> <thead> <tr> <th>Satisfaction Level</th> <th>Percentage</th> </tr> </thead> <tbody> <tr> <td>very dissatisfied</td> <td>0%</td> </tr> <tr> <td>quite dissatisfied</td> <td>0%</td> </tr> <tr> <td>neither satisfied or dissatisfied</td> <td>0%</td> </tr> <tr> <td>quite satisfied</td> <td>26,67%</td> </tr> <tr> <td>very satisfied</td> <td>66,67%</td> </tr> <tr> <td>do not know</td> <td>6,67%</td> </tr> </tbody> </table>	Satisfaction Level	Percentage	very dissatisfied	0%	quite dissatisfied	0%	neither satisfied or dissatisfied	0%	quite satisfied	26,67%	very satisfied	66,67%	do not know	6,67%		
Satisfaction Level	Percentage															
very dissatisfied	0%															
quite dissatisfied	0%															
neither satisfied or dissatisfied	0%															
quite satisfied	26,67%															
very satisfied	66,67%															
do not know	6,67%															

Figure 6.319 & Figure 6.320 Satisfaction of men and women with the possibility to combine different transport modes (during peak hours) Source: Own composition, based on the responses to question 10 of the Customer survey WP5, version Antwerp Airport

During non-peak hours																
<p>Possibility to combine different modes (men-non-peak)</p> <table border="1"> <caption>Satisfaction levels for men during non-peak hours</caption> <thead> <tr> <th>Satisfaction Level</th> <th>Percentage</th> </tr> </thead> <tbody> <tr> <td>very dissatisfied</td> <td>0%</td> </tr> <tr> <td>quite dissatisfied</td> <td>0%</td> </tr> <tr> <td>neither satisfied or dissatisfied</td> <td>0%</td> </tr> <tr> <td>quite satisfied</td> <td>33,33%</td> </tr> <tr> <td>very satisfied</td> <td>66,67%</td> </tr> <tr> <td>do not know</td> <td>0%</td> </tr> </tbody> </table>	Satisfaction Level	Percentage	very dissatisfied	0%	quite dissatisfied	0%	neither satisfied or dissatisfied	0%	quite satisfied	33,33%	very satisfied	66,67%	do not know	0%		<p>During non-peak hours, all of the respondents are quite to very satisfied. During these hours of the day, it is much more quite on the road and since most of the travellers come by car or taxi, they are in no need of alternative modes.</p>
Satisfaction Level	Percentage															
very dissatisfied	0%															
quite dissatisfied	0%															
neither satisfied or dissatisfied	0%															
quite satisfied	33,33%															
very satisfied	66,67%															
do not know	0%															
<p>Possibility to combine different modes (women-non-peak)</p> <table border="1"> <caption>Satisfaction levels for women during non-peak hours</caption> <thead> <tr> <th>Satisfaction Level</th> <th>Percentage</th> </tr> </thead> <tbody> <tr> <td>very dissatisfied</td> <td>0%</td> </tr> <tr> <td>quite dissatisfied</td> <td>0%</td> </tr> <tr> <td>neither satisfied or dissatisfied</td> <td>0%</td> </tr> <tr> <td>quite satisfied</td> <td>0%</td> </tr> <tr> <td>very satisfied</td> <td>100,00%</td> </tr> <tr> <td>do not know</td> <td>0%</td> </tr> </tbody> </table>	Satisfaction Level	Percentage	very dissatisfied	0%	quite dissatisfied	0%	neither satisfied or dissatisfied	0%	quite satisfied	0%	very satisfied	100,00%	do not know	0%		
Satisfaction Level	Percentage															
very dissatisfied	0%															
quite dissatisfied	0%															
neither satisfied or dissatisfied	0%															
quite satisfied	0%															
very satisfied	100,00%															
do not know	0%															

Figure 6.321 & Figure 6.322 Satisfaction of men and women with the possibility to combine different transport modes (during non-peak hours) Source: Own composition, based on the responses to question 10 of the Customer survey WP5, version Antwerp Airport

During peak hours															
<p>Possible use of waiting time (men-peak)</p> <table border="1"> <caption>Possible use of waiting time (men-peak)</caption> <thead> <tr> <th>Satisfaction Level</th> <th>Percentage</th> </tr> </thead> <tbody> <tr> <td>very dissatisfied</td> <td>0%</td> </tr> <tr> <td>quite dissatisfied</td> <td>0%</td> </tr> <tr> <td>neither satisfied or dissatisfied</td> <td>5,56%</td> </tr> <tr> <td>quite satisfied</td> <td>33,33%</td> </tr> <tr> <td>very satisfied</td> <td>61,11%</td> </tr> </tbody> </table>	Satisfaction Level	Percentage	very dissatisfied	0%	quite dissatisfied	0%	neither satisfied or dissatisfied	5,56%	quite satisfied	33,33%	very satisfied	61,11%		<p>The majority of the respondents are quite to very satisfied with how they can use their waiting time. Most of the business travellers at Antwerp Airport read a newspaper or work when they are waiting. Thanks to the limited waiting time (20 min.' check-in), no other entertainment is needed.</p>	
Satisfaction Level	Percentage														
very dissatisfied	0%														
quite dissatisfied	0%														
neither satisfied or dissatisfied	5,56%														
quite satisfied	33,33%														
very satisfied	61,11%														
<p>Possible use of waiting time (women-peak)</p> <table border="1"> <caption>Possible use of waiting time (women-peak)</caption> <thead> <tr> <th>Satisfaction Level</th> <th>Percentage</th> </tr> </thead> <tbody> <tr> <td>very dissatisfied</td> <td>0%</td> </tr> <tr> <td>quite dissatisfied</td> <td>6,67%</td> </tr> <tr> <td>neither satisfied or dissatisfied</td> <td>0%</td> </tr> <tr> <td>quite satisfied</td> <td>46,67%</td> </tr> <tr> <td>very satisfied</td> <td>40,00%</td> </tr> <tr> <td>do not know</td> <td>6,67%</td> </tr> </tbody> </table>	Satisfaction Level	Percentage	very dissatisfied	0%	quite dissatisfied	6,67%	neither satisfied or dissatisfied	0%	quite satisfied	46,67%	very satisfied	40,00%	do not know	6,67%	
Satisfaction Level	Percentage														
very dissatisfied	0%														
quite dissatisfied	6,67%														
neither satisfied or dissatisfied	0%														
quite satisfied	46,67%														
very satisfied	40,00%														
do not know	6,67%														

Figure 6.323 & Figure 6.324 Satisfaction of men and women with the possible use of waiting time (during peak hours) Source: Own composition, based on the responses to question 10 of the Customer survey WP5, version Antwerp Airport

During non-peak hours															
<p>Possible use of waiting time (men-non-peak)</p> <table border="1"> <caption>Possible use of waiting time (men-non-peak)</caption> <thead> <tr> <th>Satisfaction Level</th> <th>Percentage</th> </tr> </thead> <tbody> <tr> <td>very dissatisfied</td> <td>0%</td> </tr> <tr> <td>quite dissatisfied</td> <td>16,67%</td> </tr> <tr> <td>neither satisfied or dissatisfied</td> <td>16,67%</td> </tr> <tr> <td>quite satisfied</td> <td>16,67%</td> </tr> <tr> <td>very satisfied</td> <td>50,00%</td> </tr> </tbody> </table>	Satisfaction Level	Percentage	very dissatisfied	0%	quite dissatisfied	16,67%	neither satisfied or dissatisfied	16,67%	quite satisfied	16,67%	very satisfied	50,00%		<p>During non-peak hours, the situation is different: passengers travelling during the day would like to have more to do during the time they have to wait. This might be due to the fact that there is little "entertainment" available at Antwerp Airport: there is only one little airport shop and a vending machine with drinks at the gate.</p>	
Satisfaction Level	Percentage														
very dissatisfied	0%														
quite dissatisfied	16,67%														
neither satisfied or dissatisfied	16,67%														
quite satisfied	16,67%														
very satisfied	50,00%														
<p>Possible use of waiting time (women-non-peak)</p> <table border="1"> <caption>Possible use of waiting time (women-non-peak)</caption> <thead> <tr> <th>Satisfaction Level</th> <th>Percentage</th> </tr> </thead> <tbody> <tr> <td>very dissatisfied</td> <td>0%</td> </tr> <tr> <td>quite dissatisfied</td> <td>25,00%</td> </tr> <tr> <td>neither satisfied or dissatisfied</td> <td>0%</td> </tr> <tr> <td>quite satisfied</td> <td>0%</td> </tr> <tr> <td>very satisfied</td> <td>50,00%</td> </tr> <tr> <td>do not know</td> <td>25,00%</td> </tr> </tbody> </table>	Satisfaction Level	Percentage	very dissatisfied	0%	quite dissatisfied	25,00%	neither satisfied or dissatisfied	0%	quite satisfied	0%	very satisfied	50,00%	do not know	25,00%	
Satisfaction Level	Percentage														
very dissatisfied	0%														
quite dissatisfied	25,00%														
neither satisfied or dissatisfied	0%														
quite satisfied	0%														
very satisfied	50,00%														
do not know	25,00%														

Figure 6.325 & Figure 6.326: Satisfaction of men and women with the possible use of waiting time (during non-peak hours) Source: Own composition, based on the responses to question 10 of the Customer survey WP5, version Antwerp Airport

The figures above indicate that during peak hours, most of the business travellers at Antwerp Airport are satisfied with what they are offered: they think Antwerp Airport has good travel connections, is well accessible and they are satisfied with how they can use their waiting time. Since most of the passengers during peak hours are commuters to London, they know in advance what they will be offered and are satisfied with that. During non-peak hours, the situation is much alike. Given the fact that at that time of the day the roads are more quiet, travellers are even more willing to take their car. The only thing that non-peak hour travellers are missing, is some entertainment during waiting.

In Figure 6.327 and Figure 6.328, the factors influencing mode choice are indicated. During peak hours, passengers choose their mode taking into account the travel time, the waiting time, the easy transfer and the punctuality. These factors are optimal in the access mode that most respondents use, the car. Travelling to Antwerp Airport by car is probably faster than using public transport, because there is no transfer needed. Using the car as an access mode makes travelling “just in time” possible, so the waiting time can be reduced. Furthermore, the car is as punctual as the traffic allows it to be. To travel to London departing from Antwerp, there are two options: via airplane or using the Eurostar. Also here, the travel time, waiting time and transfer are optimal using the airplane. Flying only takes one hour (compared to two hours with the Eurostar), one only has to wait 20 min. (compared to 30 minutes check-in at the Eurostar) and there is only one transfer needed, between car/taxi and the airplane. When travelling with the Eurostar departing from Antwerp, one has to take the train to Brussels, so more transfers are needed. Furthermore, the survey indicated that the punctuality at Antwerp Airport is very good.

Influencing factors choice of modes (during peak hours)	Men	Women	TOTAL (per row)
Total travel time	15	11	26
Waiting time at transfer	11	6	17
Simplicity of transfer/change of mode	10	1	11
Punctuality	6	5	11
Comfort	5	5	10
Service/quality in mode	5	3	8
Ticket price		4	4
Safety/security	1	1	2
Service/quality at interchange		1	1
Environmental reasons			0

Figure 6.327: Factors that influence the choice of transport mode (during peak hours)

Source: Own composition, based on the responses to question 11 of the Customer survey WP5, version Antwerp Airport

Dominant factors choice of modes (during peak hours)	Men	Women	TOTAL (per row)
Total travel time	13	10	23
Comfort	2	1	3
Punctuality	1	1	2
Safety/security		1	1
Other: No alternatives		1	1
Other: Close to origin/destination		1	1
Waiting time at transfer	1		1
Simplicity of transfer/change of mode	1		1
Ticket price			0
Service/quality in mode			0
Service/quality at interchange			0
Environmental reasons			0

Figure 6.328: Dominant factors that influence the choice of transport mode (during peak hours)
 Source: Own composition, based on the responses to question 11 of the Customer survey WP5, version Antwerp Airport

Figure 6.329 and Figure 6.330 show the factors influencing the mode choice during non-peak hours. Here, especially travel time, easy transfer and comfort are important. Striking is the fact that also ticket price is now an important factor. This difference (compared to travelling during peak hours) can be explained by the fact that commuters travel during peak hours (and they have to get to their destination, no matter the price of the ticket) and travellers that are more price-conscious travel during non-peak hours (because during that time of the day, the ticket price is lower).

Influencing factors choice of modes (during non-peak hours)	Men	Women	TOTAL (per row)
Total travel time	6	3	9
Simplicity of transfer/change of mode	3	3	6
Comfort	4	2	6
Waiting time at transfer	1	2	3
Ticket price	2	1	3
Punctuality	1		1
Service/quality in mode	1		1
Other: no alternative		1	1
Safety/security			0
Service/quality at interchange			0

Figure 6.329: Factors that influence the choice of transport mode (during non-peak hours)
 Source: Own composition, based on the responses to question 11 of the Customer survey WP5, version Antwerp Airport

Dominant factors choice of modes (during non-peak hours)	Men	Women	TOTAL (per row)
Simplicity of transfer/change of mode	2	2	4
Total travel time	2		2
Comfort	1	1	2
Other: No alternative		1	1
Ticket price	1		1
Punctuality			0
Safety/security			0
Waiting time at transfer			0
Service/quality in mode			0
Service/quality at interchange			0
Environmental reasons			0

Figure 6.330: Dominant factors that influence the choice of transport mode (during non-peak hours)

Source: Own composition, based on the responses to question 11 of the Customer survey WP5, version Antwerp Airport

6.7.7.3 Time

6.7.7.3.1 Observation

Time as an indicator for the quality of the services is described in this section. Business passengers are very time-sensitive and since business travellers are the main customers of Antwerp Airport, it is important that the management of the airport makes an effort to save time. Therefore, at Antwerp Airport, there is a 20 min.' check-in concept. This reduces the waiting time to a minimum. Since most of the passengers are business passengers, the travellers do not carry a lot of baggage which reduces the service time. Furthermore, Antwerp Airport is an airport which is not restricted by slots: the taking off of the airplanes is only restricted by the slots at the destination airport.

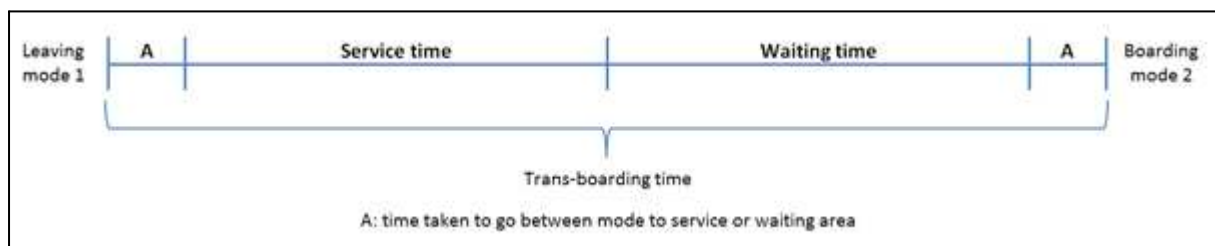


Figure 6.331: Time division Source: Template Case Study Report

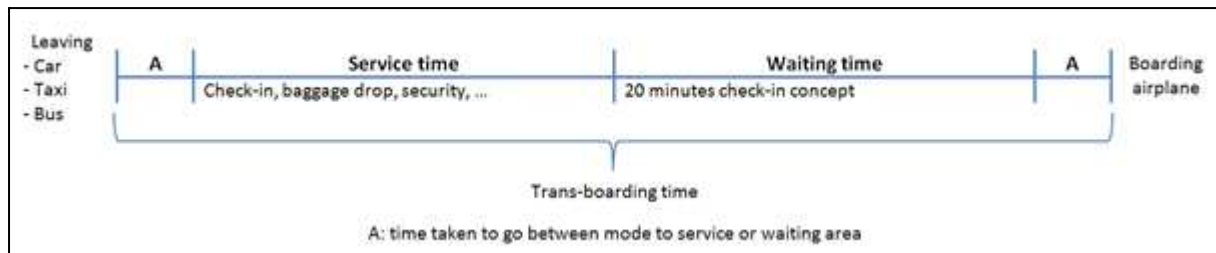


Figure 6.332: Time division for the case of Antwerp Airport

Source: Own composition, based on figure 2 (Template Case Study Report), observations at Antwerp Airport and Customer survey WP5, version Antwerp Airport

6.7.7.3.2 Passenger satisfaction - Survey

Most of the passengers travelling from Antwerp Airport are longer than 15 minutes present at the airport. Passengers arriving 45 minutes (or more) in advance, state that it is difficult to estimate their access time or mention other reasons such as rescheduling their ticket or dropping off baggage. The duration of the stay at the airport was in none of the cases dependent on any delay. This is probably thanks to the fact that Antwerp Airport is an airport without slots.

During peak hours											
<p>Duration of stay at the airport (men-peak)</p> <table border="1"> <caption>Duration of stay at the airport (men-peak)</caption> <thead> <tr> <th>Duration</th> <th>Percentage</th> </tr> </thead> <tbody> <tr> <td><5 min</td> <td>11,11%</td> </tr> <tr> <td>5-15 min</td> <td>33,33%</td> </tr> <tr> <td>16-45 min</td> <td>55,56%</td> </tr> <tr> <td>>45 min</td> <td>33,33%</td> </tr> </tbody> </table>	Duration	Percentage	<5 min	11,11%	5-15 min	33,33%	16-45 min	55,56%	>45 min	33,33%	
Duration	Percentage										
<5 min	11,11%										
5-15 min	33,33%										
16-45 min	55,56%										
>45 min	33,33%										
<p>Duration of stay at the airport (women-peak)</p> <table border="1"> <caption>Duration of stay at the airport (women-peak)</caption> <thead> <tr> <th>Duration</th> <th>Percentage</th> </tr> </thead> <tbody> <tr> <td><5 min</td> <td>6,67%</td> </tr> <tr> <td>5-15 min</td> <td>20,00%</td> </tr> <tr> <td>16-45 min</td> <td>73,33%</td> </tr> <tr> <td>>45 min</td> <td>20,00%</td> </tr> </tbody> </table>	Duration	Percentage	<5 min	6,67%	5-15 min	20,00%	16-45 min	73,33%	>45 min	20,00%	<p>The figures indicate that most of the passengers stay between 16 and 45 minutes at the airport. This is in line with the 20 minutes that they have to be there to check-in before take-off. Still, some of the travellers stay longer than 45 minutes at the airport. The main reason for that is that, during peak hours, traffic can be quite chaotic, so the access time is unpredictable. Some of the women staying longer than 45 minutes at the airport needed more time to check in baggage, or to reschedule their ticket.</p>
Duration	Percentage										
<5 min	6,67%										
5-15 min	20,00%										
16-45 min	73,33%										
>45 min	20,00%										

Figure 6.333 & Figure 6.334 Duration of stay at the airport of men and women (during peak hours)

Source: Own composition, based on the responses to question 12 of the Customer survey WP5, version Antwerp Airport

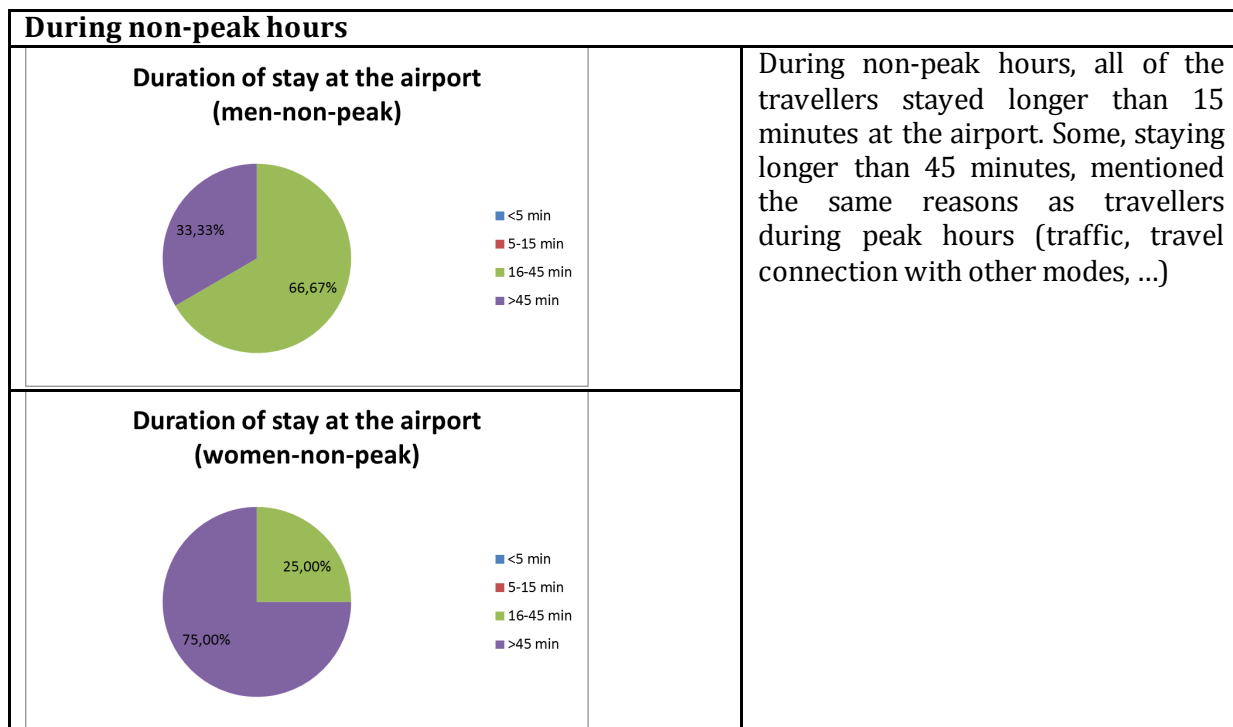


Figure 6.335 & Figure 6.336 Duration of stay at the airport of men and women (during non-peak hours)

Source: Own composition, based on the responses to question 12 of the Customer survey WP5, version Antwerp Airport

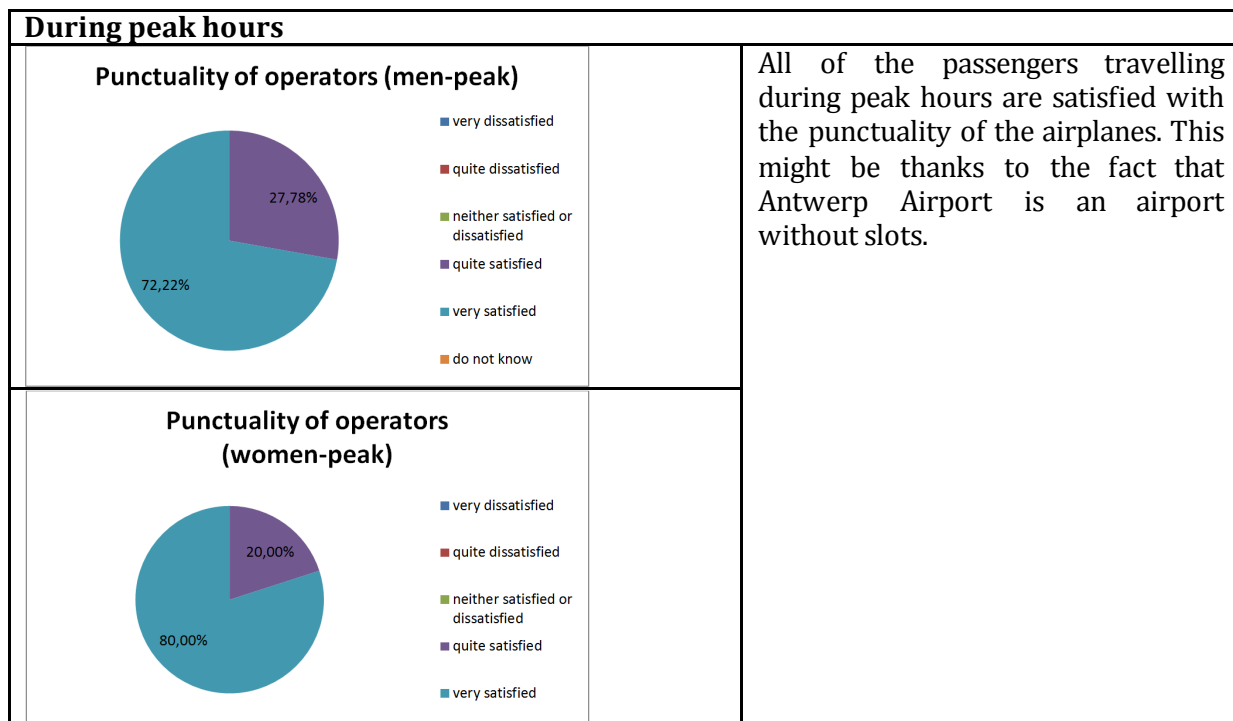


Figure 6.337 & Figure 6.338 Satisfaction of men and women with the punctuality of the transport operators (during peak hours) Source: Own composition, based on the responses to question 14 of the Customer survey WP5, version Antwerp Airport

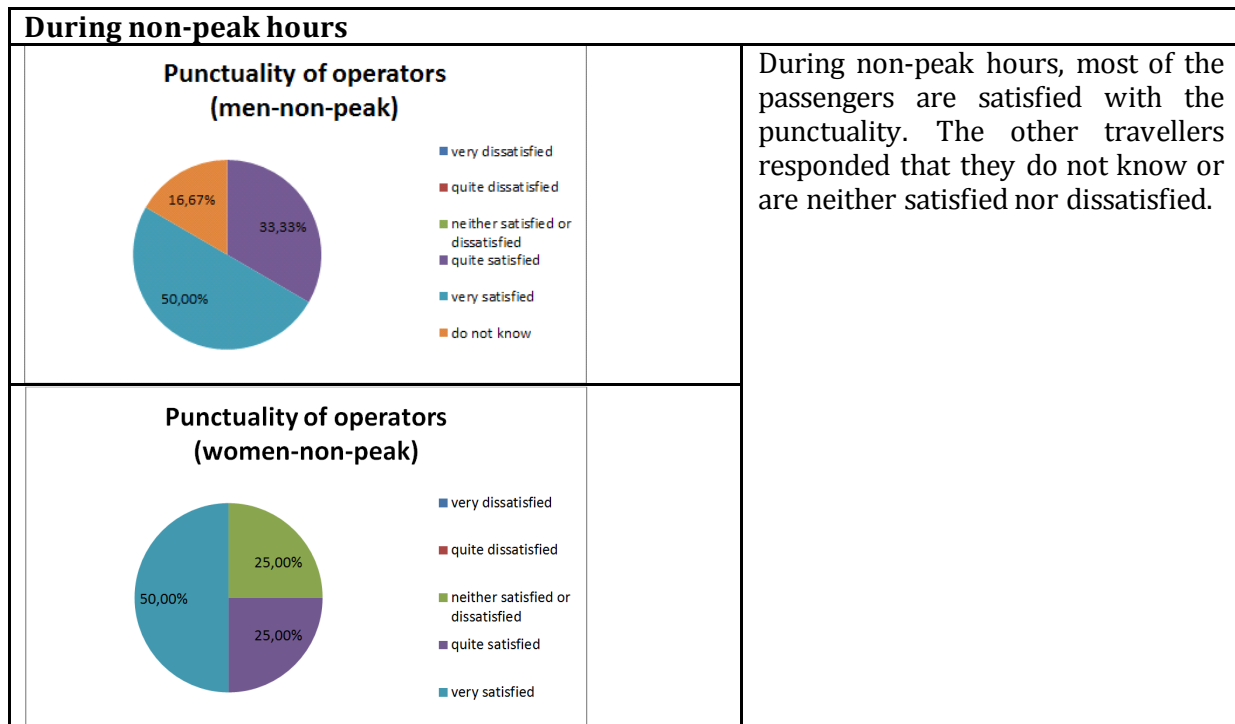


Figure 6.339 & Figure 6.340 Satisfaction of men and women with the punctuality of the transport operators (during non-peak hours)

Source: Own composition, based on the responses to question 14 of the Customer survey WP5, version Antwerp Airport

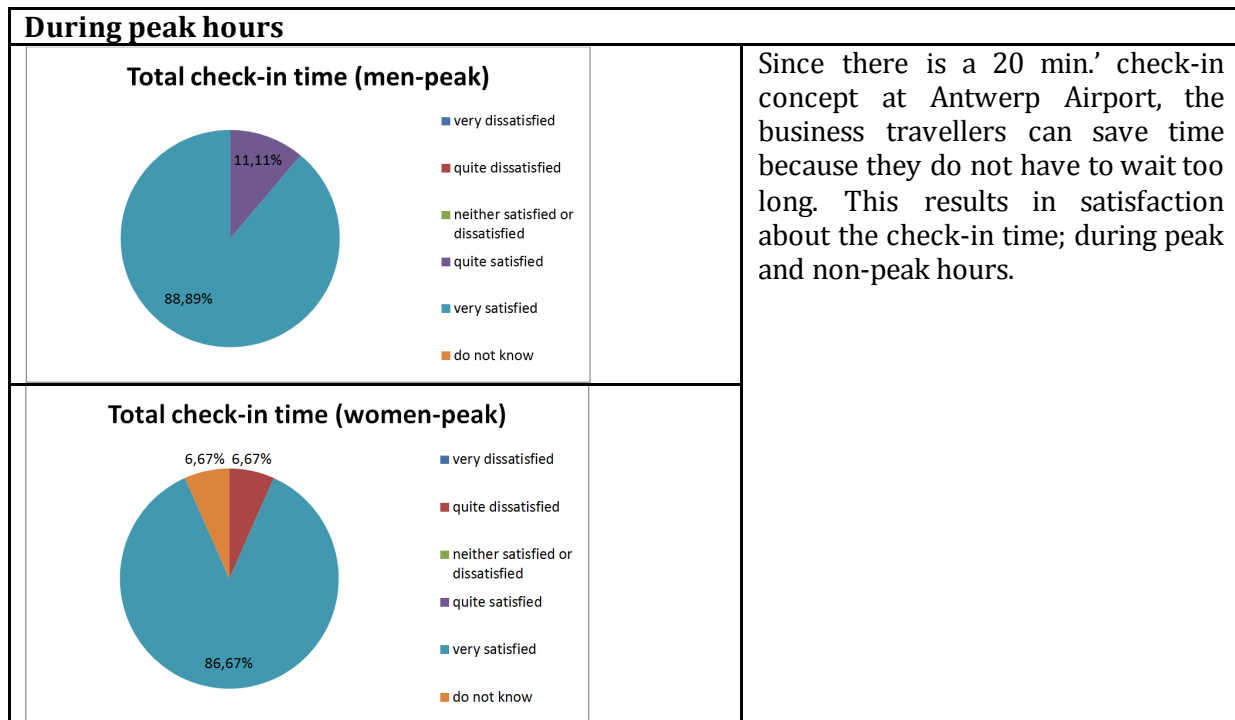


Figure 6.341 & Figure 6.342 Satisfaction of men and women with the check-in time (during peak hours)

Source: Own composition, based on the responses to question 14 of the Customer survey WP5, version Antwerp Airport

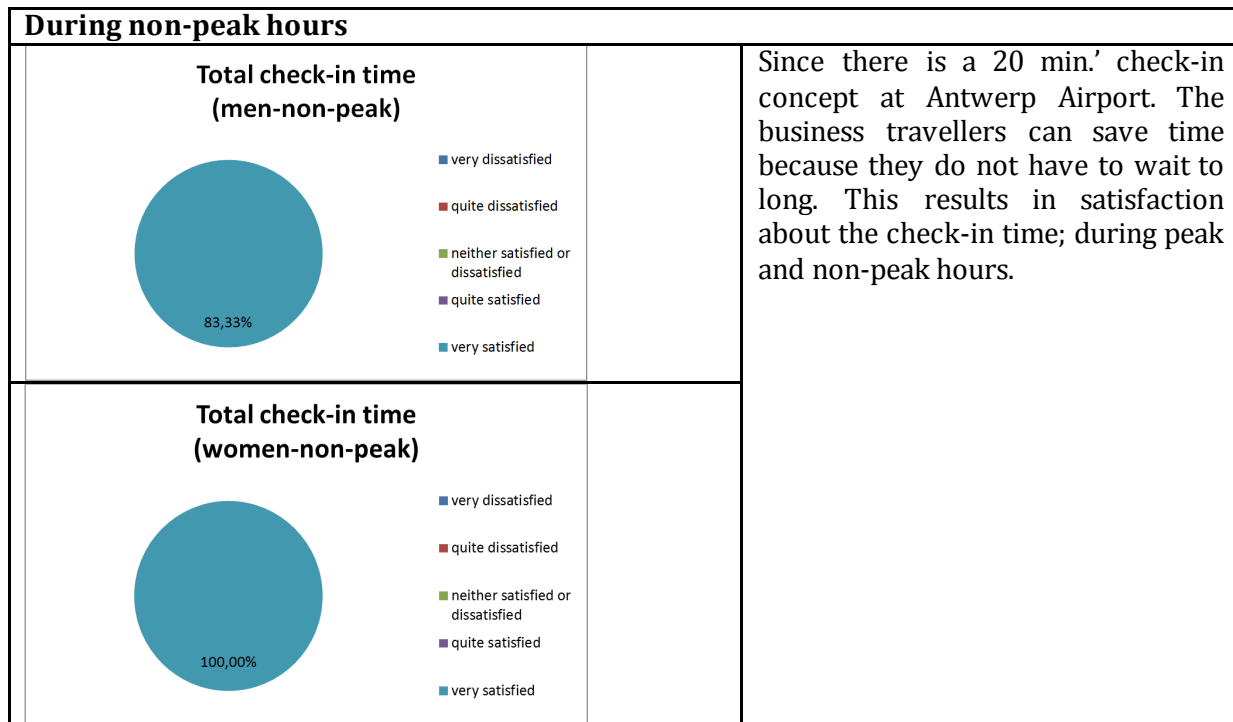


Figure 6.343 & Figure 6.344 : Satisfaction of men and women with the check-in time (during non-peak hours)

Source: Own composition, based on the responses to question 14 of the Customer survey WP5, version Antwerp Airport

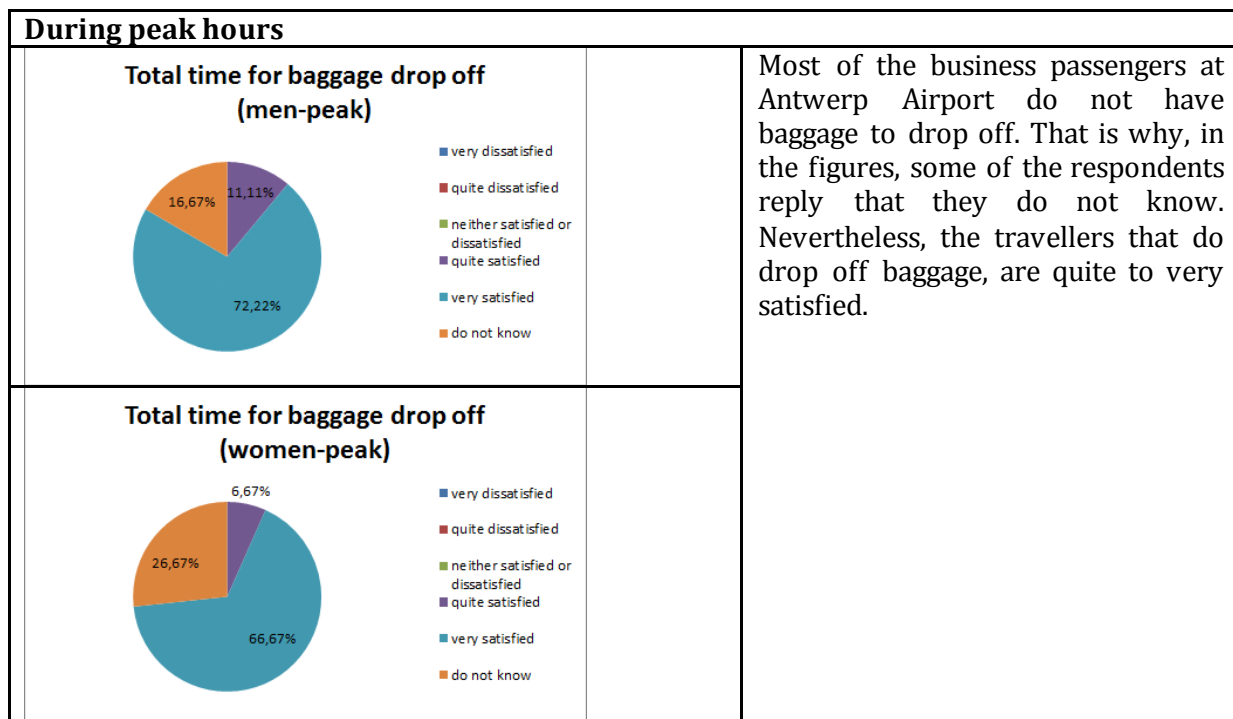


Figure 6.345 & Figure 6.346 Satisfaction of men and women with the time for baggage drop-off (during peak hours) Source: Own composition, based on the responses to question 14 of the Customer survey WP5, version Antwerp Airport

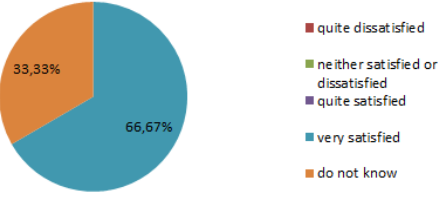
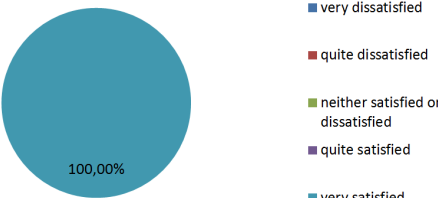
During non-peak hours														
<p>Total time for baggage drop off (men-non-peak)</p>  <table border="1"> <tr><td>very dissatisfied</td><td>0%</td></tr> <tr><td>quite dissatisfied</td><td>0%</td></tr> <tr><td>neither satisfied or dissatisfied</td><td>0%</td></tr> <tr><td>quite satisfied</td><td>0%</td></tr> <tr><td>very satisfied</td><td>66,67%</td></tr> <tr><td>do not know</td><td>33,33%</td></tr> </table>	very dissatisfied	0%	quite dissatisfied	0%	neither satisfied or dissatisfied	0%	quite satisfied	0%	very satisfied	66,67%	do not know	33,33%		<p>During non-peak hours, more women do travel with baggage and they are very satisfied with the time needed to drop off this baggage. Also the men that do carry baggage are satisfied.</p>
very dissatisfied	0%													
quite dissatisfied	0%													
neither satisfied or dissatisfied	0%													
quite satisfied	0%													
very satisfied	66,67%													
do not know	33,33%													
<p>Total time for baggage drop off (women-non-peak)</p>  <table border="1"> <tr><td>very dissatisfied</td><td>0%</td></tr> <tr><td>quite dissatisfied</td><td>0%</td></tr> <tr><td>neither satisfied or dissatisfied</td><td>0%</td></tr> <tr><td>quite satisfied</td><td>0%</td></tr> <tr><td>very satisfied</td><td>100,00%</td></tr> </table>	very dissatisfied	0%	quite dissatisfied	0%	neither satisfied or dissatisfied	0%	quite satisfied	0%	very satisfied	100,00%				
very dissatisfied	0%													
quite dissatisfied	0%													
neither satisfied or dissatisfied	0%													
quite satisfied	0%													
very satisfied	100,00%													

Figure 6.347 & Figure 6.348 Satisfaction of men and women with the time for baggage drop-off (during non-peak hours) Source: Own composition, based on the responses to question 14 of the Customer survey WP5, version Antwerp Airport

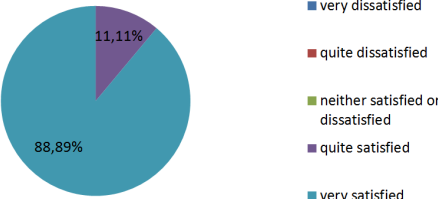
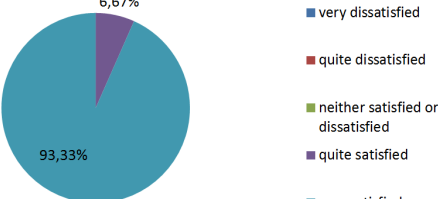
During peak hours												
<p>Total time for security controls (men-peak)</p>  <table border="1"> <tr><td>very dissatisfied</td><td>0%</td></tr> <tr><td>quite dissatisfied</td><td>0%</td></tr> <tr><td>neither satisfied or dissatisfied</td><td>0%</td></tr> <tr><td>quite satisfied</td><td>11,11%</td></tr> <tr><td>very satisfied</td><td>88,89%</td></tr> </table>	very dissatisfied	0%	quite dissatisfied	0%	neither satisfied or dissatisfied	0%	quite satisfied	11,11%	very satisfied	88,89%		<p>During peak and non-peak hours, all of the travellers are quite to very satisfied with the time needed for security controls.</p>
very dissatisfied	0%											
quite dissatisfied	0%											
neither satisfied or dissatisfied	0%											
quite satisfied	11,11%											
very satisfied	88,89%											
<p>Total time for security controls (women-peak)</p>  <table border="1"> <tr><td>very dissatisfied</td><td>0%</td></tr> <tr><td>quite dissatisfied</td><td>0%</td></tr> <tr><td>neither satisfied or dissatisfied</td><td>0%</td></tr> <tr><td>quite satisfied</td><td>6,67%</td></tr> <tr><td>very satisfied</td><td>93,33%</td></tr> </table>	very dissatisfied	0%	quite dissatisfied	0%	neither satisfied or dissatisfied	0%	quite satisfied	6,67%	very satisfied	93,33%		
very dissatisfied	0%											
quite dissatisfied	0%											
neither satisfied or dissatisfied	0%											
quite satisfied	6,67%											
very satisfied	93,33%											

Figure 6.349 & Figure 6.350 Satisfaction of men and women with the time for security controls (during peak hours) Source: Own composition, based on the responses to question 14 of the Customer survey WP5, version Antwerp Airport

During non-peak hours		
<p>Total time for security controls (men-non-peak)</p> <p>100,00%</p> <ul style="list-style-type: none"> ■ very dissatisfied ■ quite dissatisfied ■ neither satisfied or dissatisfied ■ quite satisfied ■ very satisfied 		<p>During peak and non-peak hours, all of the travellers are quite to very satisfied with the time needed for security controls.</p>
<p>Total time for security controls (women-non-peak)</p> <p>100,00%</p> <ul style="list-style-type: none"> ■ very dissatisfied ■ quite dissatisfied ■ neither satisfied or dissatisfied ■ quite satisfied ■ very satisfied 		

Figure 6.351 & Figure 6.352 Satisfaction of men and women with the time for security controls (during non-peak hours) Source: Own composition, based on the responses to question 14 of the Customer survey WP5, version Antwerp Airport

During peak hours		
<p>Time spent for transfer between modes (men-peak)</p> <p>88,89%</p> <p>11,11%</p> <ul style="list-style-type: none"> ■ very dissatisfied ■ quite dissatisfied ■ neither satisfied or dissatisfied ■ quite satisfied ■ very satisfied 		<p>Since most of the passengers come to the airport using their car or a taxi and there is a large, free parking space in front of the airport building, no time is wasted for transfer. That is why all of the passengers are quite to very satisfied with the transfer time.</p>
<p>Time spent for transfer between modes (women-peak)</p> <p>86,67%</p> <p>13,33%</p> <ul style="list-style-type: none"> ■ very dissatisfied ■ quite dissatisfied ■ neither satisfied or dissatisfied ■ quite satisfied ■ very satisfied 		

Figure 6.353 & Figure 6.354 Satisfaction of men and women with the time spent for transfer between transport modes (during peak hours) Source: Own composition, based on the responses to question 14 of the Customer survey WP5, version Antwerp Airport

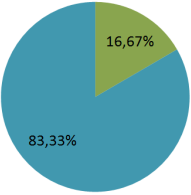
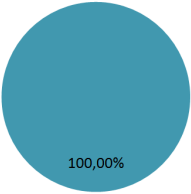
During non-peak hours		
<p>Time spent for transfer between modes (men-non-peak)</p>  <ul style="list-style-type: none"> ■ very dissatisfied ■ quite dissatisfied ■ neither satisfied or dissatisfied ■ quite satisfied ■ very satisfied 		<p>During non-peak hours, also most of the passengers are very satisfied; there are only some men who are neither satisfied nor dissatisfied.</p>
<p>Time spent for transfer between modes (women-non-peak)</p>  <ul style="list-style-type: none"> ■ very dissatisfied ■ quite dissatisfied ■ neither satisfied or dissatisfied ■ quite satisfied ■ very satisfied 		

Figure 6.355 & Figure 6.356 Satisfaction of men and women with the time spent for transfer between transport modes (during non-peak hours)Source: Own composition, based on the responses to question 14 of the Customer survey WP5, version Antwerp Airport

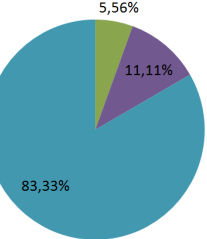
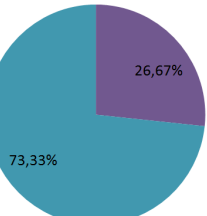
During peak hours		
<p>Total waiting time (men-peak)</p>  <ul style="list-style-type: none"> ■ very dissatisfied ■ quite dissatisfied ■ neither satisfied or dissatisfied ■ quite satisfied ■ very satisfied ■ do not know 		<p>Thanks to the 20 min.' check-in time, passengers do not have to wait too long before the plane takes off. This makes that most of the travellers are quite to very satisfied with the waiting time.</p>
<p>Total waiting time (women-peak)</p>  <ul style="list-style-type: none"> ■ very dissatisfied ■ quite dissatisfied ■ neither satisfied or dissatisfied ■ quite satisfied ■ very satisfied ■ do not know 		

Figure 6.357 & Figure 6.358 Satisfaction of men and women with the total waiting time (during peak hours)

Source: Own composition, based on the responses to question 14 of the Customer survey WP5, version Antwerp Airport

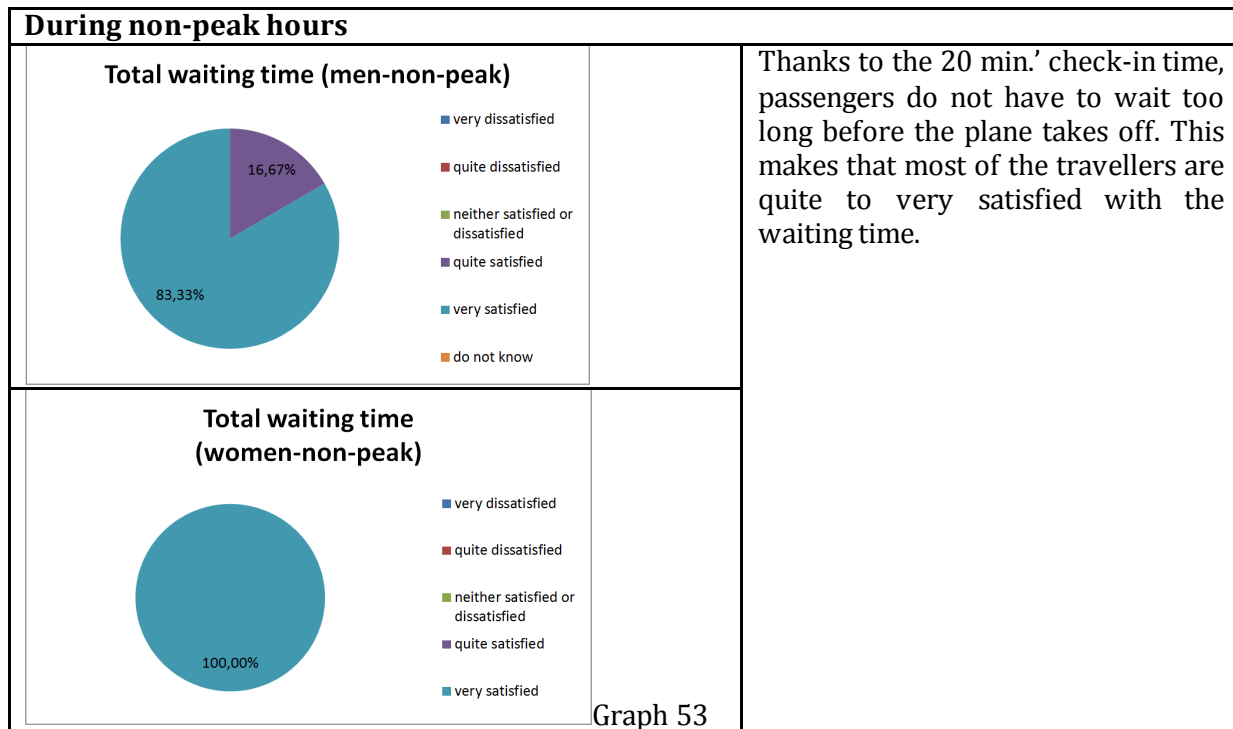


Figure 6.359 & Figure 6.360 Satisfaction of men and women with the total waiting time (during non-peak hours) Source: Own composition, based on the responses to question 14 of the Customer survey WP5, version Antwerp Airport

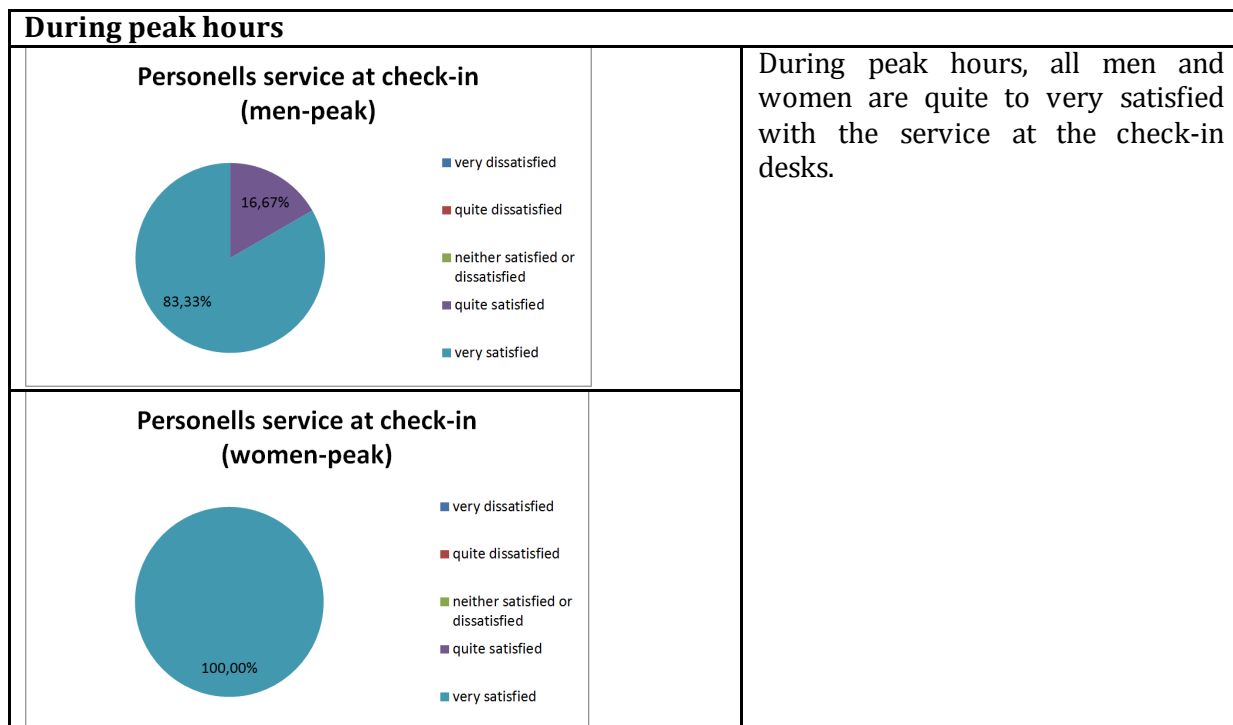


Figure 6.361 & Figure 6.362 Satisfaction of men and women with the personnel's service at check-in counters (during peak hours) Source: Own composition, based on the responses to question 14 of the Customer survey WP5, version Antwerp Airport

During non-peak hours																
<p>Personells service at check-in (men-non-peak)</p> <table border="1"> <caption>Personells service at check-in (men-non-peak)</caption> <thead> <tr> <th>Satisfaction Level</th> <th>Percentage</th> </tr> </thead> <tbody> <tr> <td>very dissatisfied</td> <td>0%</td> </tr> <tr> <td>quite dissatisfied</td> <td>0%</td> </tr> <tr> <td>neither satisfied or dissatisfied</td> <td>0%</td> </tr> <tr> <td>quite satisfied</td> <td>16,67%</td> </tr> <tr> <td>very satisfied</td> <td>66,67%</td> </tr> <tr> <td>do not know</td> <td>16,67%</td> </tr> </tbody> </table>	Satisfaction Level	Percentage	very dissatisfied	0%	quite dissatisfied	0%	neither satisfied or dissatisfied	0%	quite satisfied	16,67%	very satisfied	66,67%	do not know	16,67%		<p>During non-peak hours, some men checked in online. That is why they do not know whether the service at the check-in desks is satisfying. The travellers who did check in at the desks are quite to very satisfied with the service delivered.</p>
Satisfaction Level	Percentage															
very dissatisfied	0%															
quite dissatisfied	0%															
neither satisfied or dissatisfied	0%															
quite satisfied	16,67%															
very satisfied	66,67%															
do not know	16,67%															
<p>Personells service at check-in (women-non-peak)</p> <table border="1"> <caption>Personells service at check-in (women-non-peak)</caption> <thead> <tr> <th>Satisfaction Level</th> <th>Percentage</th> </tr> </thead> <tbody> <tr> <td>very dissatisfied</td> <td>0%</td> </tr> <tr> <td>quite dissatisfied</td> <td>0%</td> </tr> <tr> <td>neither satisfied or dissatisfied</td> <td>0%</td> </tr> <tr> <td>quite satisfied</td> <td>0%</td> </tr> <tr> <td>very satisfied</td> <td>100,00%</td> </tr> <tr> <td>do not know</td> <td>0%</td> </tr> </tbody> </table>	Satisfaction Level	Percentage	very dissatisfied	0%	quite dissatisfied	0%	neither satisfied or dissatisfied	0%	quite satisfied	0%	very satisfied	100,00%	do not know	0%		
Satisfaction Level	Percentage															
very dissatisfied	0%															
quite dissatisfied	0%															
neither satisfied or dissatisfied	0%															
quite satisfied	0%															
very satisfied	100,00%															
do not know	0%															

Figure 6.363 & Figure 6.364 Satisfaction of men and women with the personnel’s service at check-in counters (during non-peak hours) Source: Own composition, based on the responses to question 14 of the Customer survey WP5, version Antwerp Airport

During peak hours																
<p>Check-in for people with disabilities (men-peak)</p> <table border="1"> <caption>Check-in for people with disabilities (men-peak)</caption> <thead> <tr> <th>Satisfaction Level</th> <th>Percentage</th> </tr> </thead> <tbody> <tr> <td>very dissatisfied</td> <td>0%</td> </tr> <tr> <td>quite dissatisfied</td> <td>0%</td> </tr> <tr> <td>neither satisfied or dissatisfied</td> <td>0%</td> </tr> <tr> <td>quite satisfied</td> <td>5,56%</td> </tr> <tr> <td>very satisfied</td> <td>0%</td> </tr> <tr> <td>do not know</td> <td>94,44%</td> </tr> </tbody> </table>	Satisfaction Level	Percentage	very dissatisfied	0%	quite dissatisfied	0%	neither satisfied or dissatisfied	0%	quite satisfied	5,56%	very satisfied	0%	do not know	94,44%		<p>Since most of the travellers are business travellers, they do not know how satisfying check-in facilities for disabled people are. The few travellers that do have experience with this state that they are quite to very satisfied.</p>
Satisfaction Level	Percentage															
very dissatisfied	0%															
quite dissatisfied	0%															
neither satisfied or dissatisfied	0%															
quite satisfied	5,56%															
very satisfied	0%															
do not know	94,44%															
<p>Check-in for people with disabilities (women-peak)</p> <table border="1"> <caption>Check-in for people with disabilities (women-peak)</caption> <thead> <tr> <th>Satisfaction Level</th> <th>Percentage</th> </tr> </thead> <tbody> <tr> <td>very dissatisfied</td> <td>0%</td> </tr> <tr> <td>quite dissatisfied</td> <td>0%</td> </tr> <tr> <td>neither satisfied or dissatisfied</td> <td>0%</td> </tr> <tr> <td>quite satisfied</td> <td>0%</td> </tr> <tr> <td>very satisfied</td> <td>13,33%</td> </tr> <tr> <td>do not know</td> <td>86,67%</td> </tr> </tbody> </table>	Satisfaction Level	Percentage	very dissatisfied	0%	quite dissatisfied	0%	neither satisfied or dissatisfied	0%	quite satisfied	0%	very satisfied	13,33%	do not know	86,67%		
Satisfaction Level	Percentage															
very dissatisfied	0%															
quite dissatisfied	0%															
neither satisfied or dissatisfied	0%															
quite satisfied	0%															
very satisfied	13,33%															
do not know	86,67%															

Figure 6.365 & Figure 6.366: Satisfaction of men and women with the check-in service for people with disabilities (during peak hours) Source: Own composition, based on the responses to question 14 of the Customer survey WP5, version Antwerp Airport

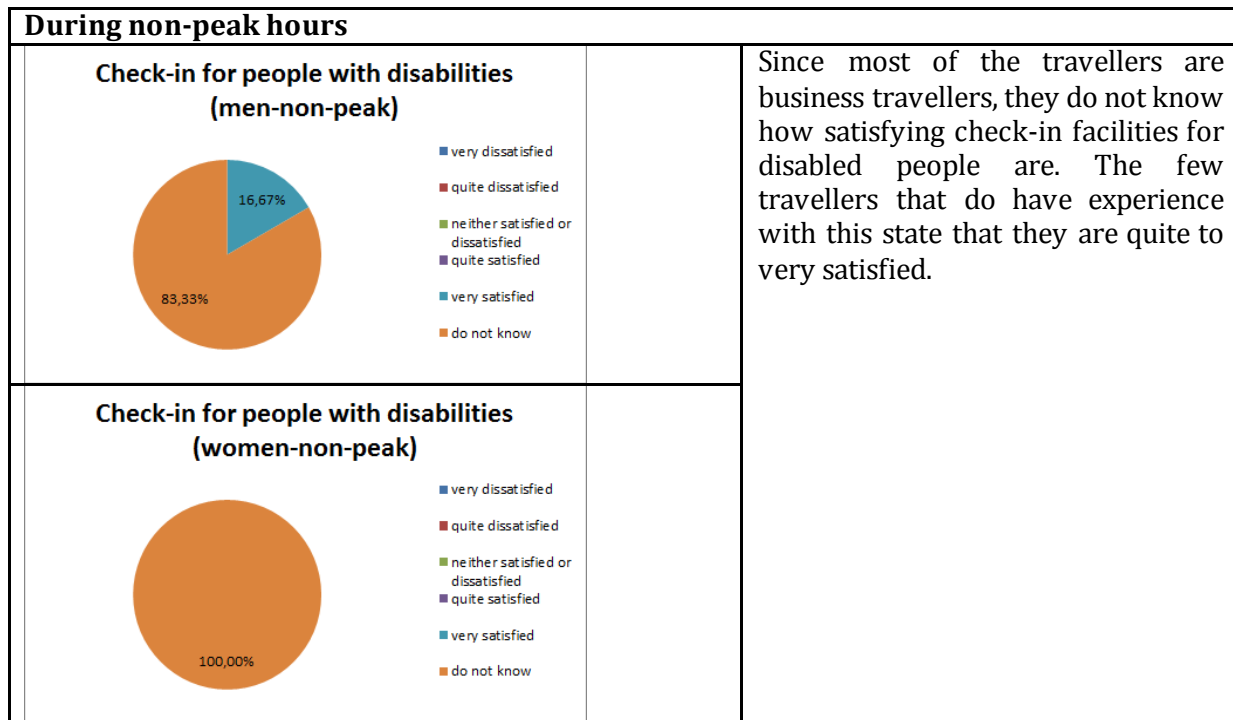


Figure 6.367 & Figure 6.368: Satisfaction of men and women with the check-in service for people with disabilities (during non-peak hours) Source: Own composition, based on the responses to question 14 of the Customer survey WP5, version Antwerp Airport

6.7.7.3.3 Service time

The service time consists of the time needed for check-in, baggage drop-off and security controls. At Antwerp Airport, most of the passengers are satisfied with all three stages of their journey, during peak hours as well as during non-peak hours. The respondents also indicated that they are satisfied with the service the personnel delivers.

6.7.7.3.4 Waiting time

Thanks to the 20 min.' check-in time and the satisfying punctuality of the airline, the waiting time for the travellers is reduced to a minimum. The respondents, during peak and non-peak hours, clearly indicate that they are satisfied with the waiting time.

6.7.7.3.5 Trans-boarding time

The total trans-boarding time consists of the service time, the waiting time, but also the transfer time. Travellers at Antwerp Airport are also satisfied with the transfer time

6.7.7.4 *Space*

In the following section, the space at the airport is described. This concerns distances as well as facilities at the site. The figure below illustrates this.

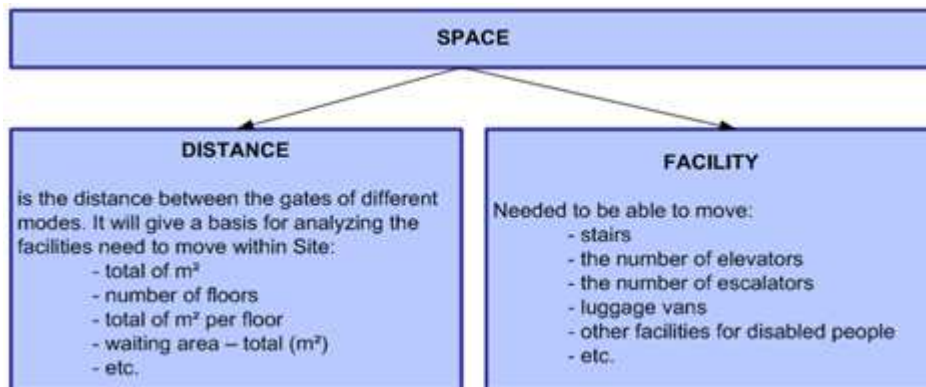


Figure 6.369: Space as the measure of the quality of service Source: Template Case Study Report

6.7.7.4.1 Observation

Antwerp Airport is a rather small airport. The building is of limited size and accessible through sliding doors and a revolving door. Thanks to the short walking distances (e.g. the check-in counters are 10 metres away from the entrance door and the between check-in and the gate is about 30 meters), travellers are in no need of luggage trolleys. These trolleys are nonetheless available at the entrance of the airport. Given the 20 min.' check-in concept, most passengers do not arrive too much in advance and are in no need of seating places in the airport, but go straight on to the gate where there are plenty of seats. At Antwerp Airport, all the passenger areas are on the ground floor. Stairs and an elevator lead up to the first floor where there are offices (e.g. of the airport management).

6.7.7.4.2 Passenger satisfaction - survey

The figures below show that it is quite easy finding your way at Antwerp Airport. Thanks to the short walking distances, having a lot of information signs is unnecessary. Even passengers that are not that familiar with the airport can easily find their way. However, during peak hours, some travellers indicate that a sign with "Entrance Gate" or a personnel member guiding the way, would make it easier to move in the right direction after checking in. These remarks were not given during non-peak hours, so due to the chaos of the morning rush, it is probably harder to find the way to the gate.

During peak hours												
<p>Find way at the airport (men-peak)</p> <table border="1"> <tr> <th>Category</th> <th>Percentage</th> </tr> <tr> <td>Quite easy (men-peak)</td> <td>38,89%</td> </tr> <tr> <td>Very easy (men-peak)</td> <td>61,11%</td> </tr> </table>	Category	Percentage	Quite easy (men-peak)	38,89%	Very easy (men-peak)	61,11%		<p>More than 60% of the male respondents found their way around the airport very easily. The other male respondents thought it was quite easy to find their way.</p>				
Category	Percentage											
Quite easy (men-peak)	38,89%											
Very easy (men-peak)	61,11%											
<p>Quite easy (men-peak)</p> <table border="1"> <tr> <th>Category</th> <th>Percentage</th> </tr> <tr> <td>Not familiar at all</td> <td>0%</td> </tr> <tr> <td>Somewhat familiar</td> <td>14,29%</td> </tr> <tr> <td>Quite familiar</td> <td>71,43%</td> </tr> <tr> <td>Very familiar</td> <td>14,29%</td> </tr> </table>	Category	Percentage	Not familiar at all	0%	Somewhat familiar	14,29%	Quite familiar	71,43%	Very familiar	14,29%		<p>The respondents who found their way quite easily, were mostly quite or very familiar with the airport.</p>
Category	Percentage											
Not familiar at all	0%											
Somewhat familiar	14,29%											
Quite familiar	71,43%											
Very familiar	14,29%											
<p>Very easy (men-peak)</p> <table border="1"> <tr> <th>Category</th> <th>Percentage</th> </tr> <tr> <td>Not familiar at all</td> <td>9,09%</td> </tr> <tr> <td>Somewhat familiar</td> <td>9,09%</td> </tr> <tr> <td>Quite familiar</td> <td>27,27%</td> </tr> <tr> <td>Very familiar</td> <td>54,55%</td> </tr> </table>	Category	Percentage	Not familiar at all	9,09%	Somewhat familiar	9,09%	Quite familiar	27,27%	Very familiar	54,55%		<p>Even respondents who were not familiar at all with the airport, had no trouble in finding their way.</p>
Category	Percentage											
Not familiar at all	9,09%											
Somewhat familiar	9,09%											
Quite familiar	27,27%											
Very familiar	54,55%											

Figure 6.370, Figure 6.371 & Figure 6.372 Men finding their way at the airport (during peak hours)

Source: Own composition, based on the responses to questions 15 and 16 of the Customer survey WP5, version Antwerp Airport

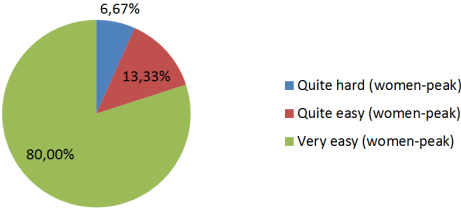
During peak hours	
<p>Find way at the airport (women-peak)</p>  <p>6,67% 13,33% 80,00%</p> <ul style="list-style-type: none"> ■ Quite hard (women-peak) ■ Quite easy (women-peak) ■ Very easy (women-peak) 	<p>Most of the female respondents thought it was quite or even very easy to find their way. Still, there were some travellers that responded that finding their way was quite hard.</p>
<p>Quite hard (women-peak)</p>  <p>100,00%</p> <ul style="list-style-type: none"> ■ Not familiar at all ■ Somewhat familiar ■ Quite familiar ■ Very familiar 	<p>The women who thought finding their way at the airport was hard were not familiar at all with the airport. The crowded atmosphere during the peak rush might have something to do with it.</p>
<p>Quite easy (women-peak)</p>  <p>50,00% 50,00%</p> <ul style="list-style-type: none"> ■ Not familiar at all ■ Somewhat familiar ■ Quite familiar ■ Very familiar 	<p>Female travellers who are quite to very familiar with the airport, find it easy to get to the gate. Even some respondents who were not at the airport before had no trouble finding their way.</p>
<p>Very easy (women-peak)</p>  <p>16,67% 16,67% 66,67%</p> <ul style="list-style-type: none"> ■ Not familiar at all ■ Somewhat familiar ■ Quite familiar ■ Very familiar 	

Figure 6.373, Figure 6.374, Figure 6.375 & Figure 6.376 Women finding their way at the airport (during peak hours) Source: Own composition, based on the responses to questions 15 and 16 of the Customer survey WP5, version Antwerp Airport

During non-peak hours		
<p>Find way at the airport (men-non-peak)</p> <p>100,00%</p> <ul style="list-style-type: none"> Quite easy Very easy (men-non-peak) 		<p>All men travelling during non-peak hours thought it was very easy to find their way.</p>
<p>Very easy (men-non-peak)</p> <p>33,33% 33,33% 33,33%</p> <ul style="list-style-type: none"> Not familiar at all Somewhat familiar Quite familiar Very familiar 		<p>Even men who never visited the airport before, had no trouble finding their way. This confirms that at busy periods, some people might get lost, but at quiet times, the way to the gate is easy to find.</p>

Figure 6.377 & Figure 6.378 Men finding their way at the airport (during non-peak hours)

Source: Own composition, based on the responses to questions 15 and 16 of the Customer survey WP5, version Antwerp Airport

During non-peak hours		
<p>Find way at the airport (women-non-peak)</p> <p>100,00%</p> <ul style="list-style-type: none"> Quite hard Quite easy Very easy (women-non-peak) 		<p>During non-peak hours all of the female passengers responded that it was very easy to find their way at the airport, even the travellers who were not at all familiar with the airport.</p>
<p>Very easy (women-non-peak)</p> <p>50,00% 50,00%</p> <ul style="list-style-type: none"> Not familiar at all Somewhat familiar Quite familiar Very familiar 		

Figure 6.379 & Figure 6.380 Women finding their way at the airport (during non-peak hours)

Source: Own composition, based on the responses to questions 15 and 16 of the Customer survey WP5, version Antwerp Airport

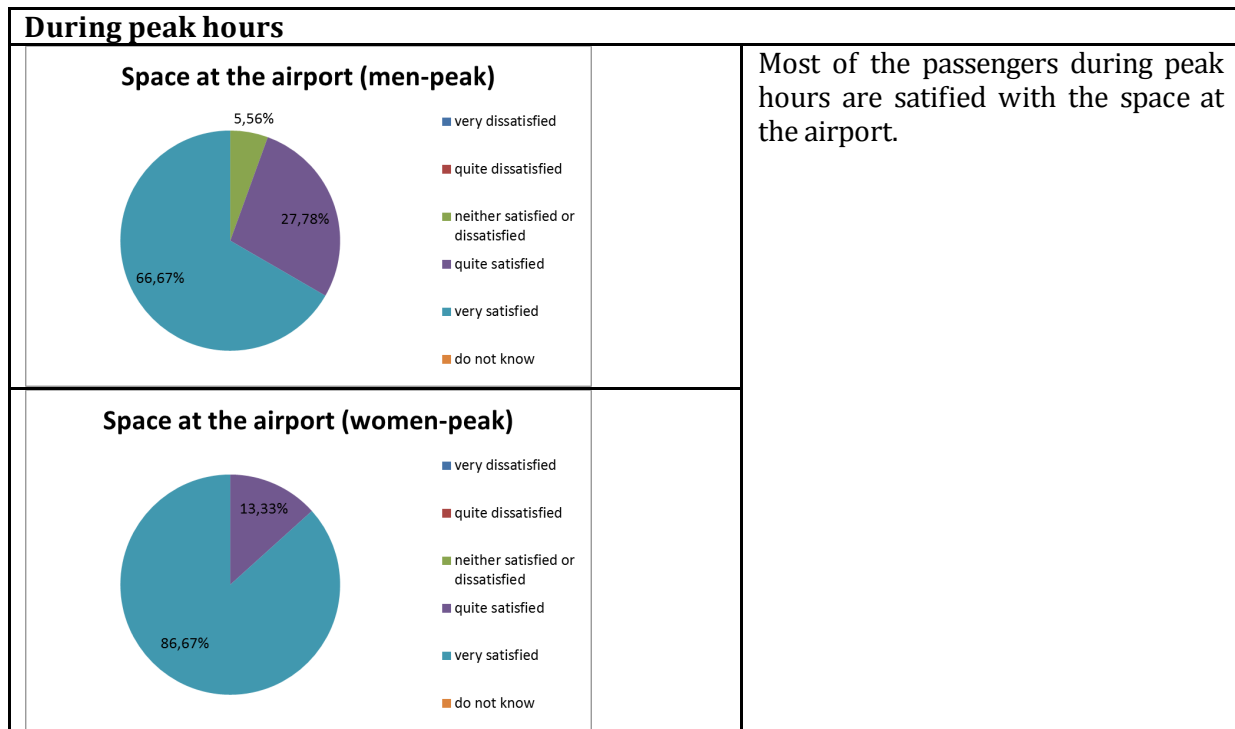


Figure 6.381 & Figure 6.382 Satisfaction of men and women with the space at the airport (during peak hours)

Source: Own composition, based on the responses to question 18 of the Customer survey WP5, version Antwerp Airport

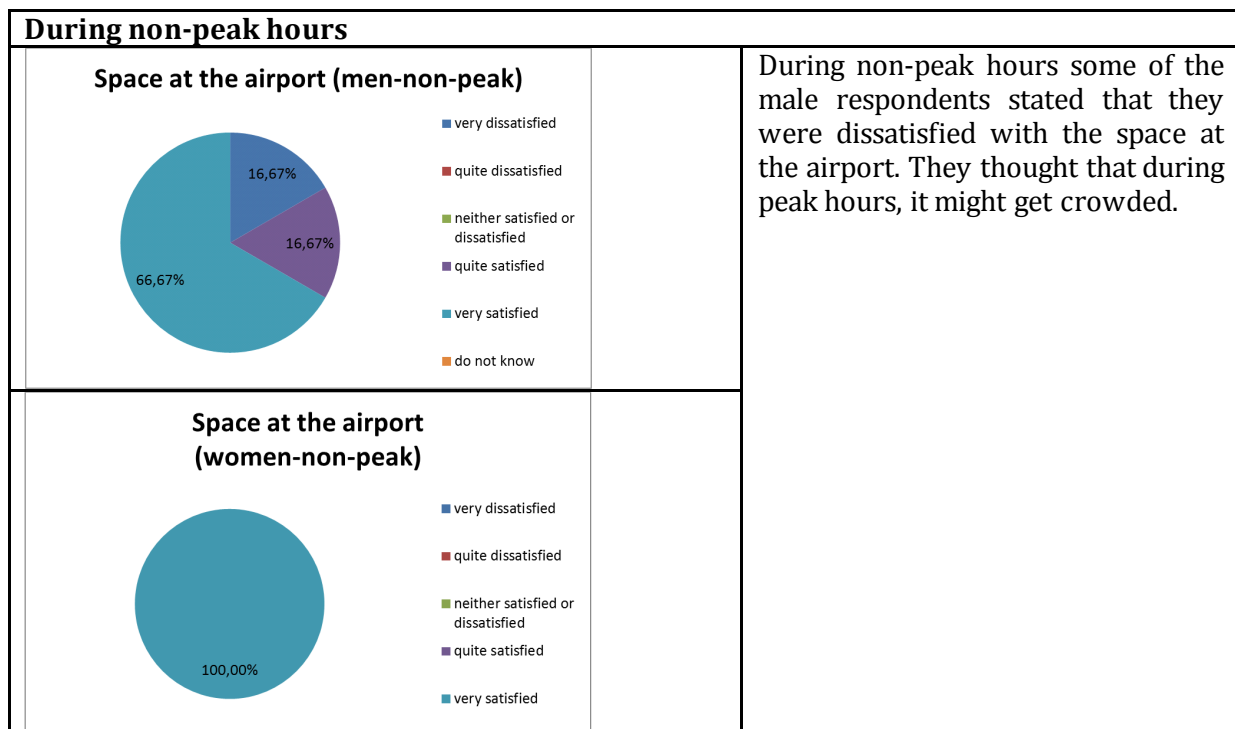


Figure 6.383 & Figure 6.384 Satisfaction of men and women with the space at the airport (during non-peak hours) Source: Own composition, based on the responses to question 18 of the Customer survey WP5, version Antwerp Airport

During peak hours												
<p>Seating capacity at the gate (men-peak)</p> <table border="1"> <tr><td>very dissatisfied</td><td>0%</td></tr> <tr><td>quite dissatisfied</td><td>0%</td></tr> <tr><td>neither satisfied or dissatisfied</td><td>0%</td></tr> <tr><td>quite satisfied</td><td>27,78%</td></tr> <tr><td>very satisfied</td><td>72,22%</td></tr> </table>	very dissatisfied	0%	quite dissatisfied	0%	neither satisfied or dissatisfied	0%	quite satisfied	27,78%	very satisfied	72,22%		<p>Since there are more seats available than there are passengers, every traveller has at least one seat. This makes that, during peak hours, all of the respondents were quite to very satisfied with the seating capacity at the gate.</p>
very dissatisfied	0%											
quite dissatisfied	0%											
neither satisfied or dissatisfied	0%											
quite satisfied	27,78%											
very satisfied	72,22%											
<p>Seating capacity at the gate (women-peak)</p> <table border="1"> <tr><td>very dissatisfied</td><td>0%</td></tr> <tr><td>quite dissatisfied</td><td>0%</td></tr> <tr><td>neither satisfied or dissatisfied</td><td>0%</td></tr> <tr><td>quite satisfied</td><td>6,67%</td></tr> <tr><td>very satisfied</td><td>93,33%</td></tr> </table>	very dissatisfied	0%	quite dissatisfied	0%	neither satisfied or dissatisfied	0%	quite satisfied	6,67%	very satisfied	93,33%		
very dissatisfied	0%											
quite dissatisfied	0%											
neither satisfied or dissatisfied	0%											
quite satisfied	6,67%											
very satisfied	93,33%											

Figure 6.385 & Figure 6.386 Satisfaction of men and women with the seating capacity at the gate (during peak hours) Source: Own composition, based on the responses to question 18 of the Customer survey WP5, version Antwerp Airport

During non-peak hours												
<p>Seating capacity at the gate (men-non-peak)</p> <table border="1"> <tr><td>very dissatisfied</td><td>0%</td></tr> <tr><td>quite dissatisfied</td><td>0%</td></tr> <tr><td>neither satisfied or dissatisfied</td><td>0%</td></tr> <tr><td>quite satisfied</td><td>33,33%</td></tr> <tr><td>very satisfied</td><td>66,67%</td></tr> </table>	very dissatisfied	0%	quite dissatisfied	0%	neither satisfied or dissatisfied	0%	quite satisfied	33,33%	very satisfied	66,67%		<p>During non-peak hours, there are less passengers than during peak hours. Since there are plenty of seats during the busiest time of the day, there are more than plenty of seats during non-peak hours. That is why all the respondents are quite to very satisfied.</p>
very dissatisfied	0%											
quite dissatisfied	0%											
neither satisfied or dissatisfied	0%											
quite satisfied	33,33%											
very satisfied	66,67%											
<p>Seating capacity at the gate (women-non-peak)</p> <table border="1"> <tr><td>very dissatisfied</td><td>0%</td></tr> <tr><td>quite dissatisfied</td><td>0%</td></tr> <tr><td>neither satisfied or dissatisfied</td><td>0%</td></tr> <tr><td>quite satisfied</td><td>0%</td></tr> <tr><td>very satisfied</td><td>100,00%</td></tr> </table>	very dissatisfied	0%	quite dissatisfied	0%	neither satisfied or dissatisfied	0%	quite satisfied	0%	very satisfied	100,00%		
very dissatisfied	0%											
quite dissatisfied	0%											
neither satisfied or dissatisfied	0%											
quite satisfied	0%											
very satisfied	100,00%											

Figure 6.387 & Figure 6.388 Satisfaction of men and women with the seating capacity at the gate (during non-peak hours) Source: Own composition, based on the responses to question 18 of the Customer survey WP5, version Antwerp Airport

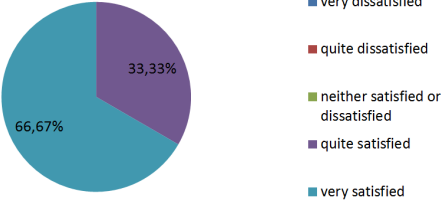
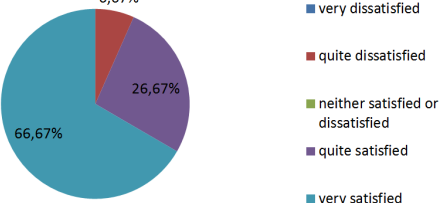
During peak hours														
<p>Total seating capacity at the airport (men-peak)</p>  <table border="1"> <caption>Satisfaction levels for men during peak hours</caption> <thead> <tr> <th>Satisfaction Level</th> <th>Percentage</th> </tr> </thead> <tbody> <tr> <td>very dissatisfied</td> <td>0%</td> </tr> <tr> <td>quite dissatisfied</td> <td>0%</td> </tr> <tr> <td>neither satisfied or dissatisfied</td> <td>0%</td> </tr> <tr> <td>quite satisfied</td> <td>33,33%</td> </tr> <tr> <td>very satisfied</td> <td>66,67%</td> </tr> </tbody> </table>	Satisfaction Level	Percentage	very dissatisfied	0%	quite dissatisfied	0%	neither satisfied or dissatisfied	0%	quite satisfied	33,33%	very satisfied	66,67%		<p>Most of the passengers are quite to very satisfied with the seating capacity at the airport.</p>
Satisfaction Level	Percentage													
very dissatisfied	0%													
quite dissatisfied	0%													
neither satisfied or dissatisfied	0%													
quite satisfied	33,33%													
very satisfied	66,67%													
<p>Total seating capacity at the airport (women-peak)</p>  <table border="1"> <caption>Satisfaction levels for women during peak hours</caption> <thead> <tr> <th>Satisfaction Level</th> <th>Percentage</th> </tr> </thead> <tbody> <tr> <td>very dissatisfied</td> <td>0%</td> </tr> <tr> <td>quite dissatisfied</td> <td>6,67%</td> </tr> <tr> <td>neither satisfied or dissatisfied</td> <td>0%</td> </tr> <tr> <td>quite satisfied</td> <td>26,67%</td> </tr> <tr> <td>very satisfied</td> <td>66,67%</td> </tr> </tbody> </table>	Satisfaction Level	Percentage	very dissatisfied	0%	quite dissatisfied	6,67%	neither satisfied or dissatisfied	0%	quite satisfied	26,67%	very satisfied	66,67%		
Satisfaction Level	Percentage													
very dissatisfied	0%													
quite dissatisfied	6,67%													
neither satisfied or dissatisfied	0%													
quite satisfied	26,67%													
very satisfied	66,67%													

Figure 6.389 & Figure 6.390 Satisfaction of men and women with the total seating capacity at the airport (during peak hours) Source: Own composition, based on the responses to question 18 of the Customer survey WP5, version Antwerp Airport

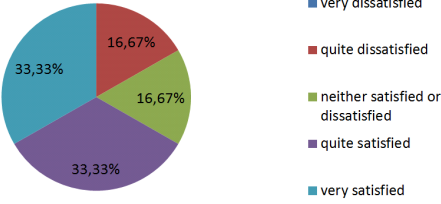
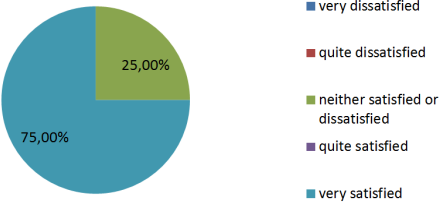
During non-peak hours														
<p>Total seating capacity at the airport (men-non-peak)</p>  <table border="1"> <caption>Satisfaction levels for men during non-peak hours</caption> <thead> <tr> <th>Satisfaction Level</th> <th>Percentage</th> </tr> </thead> <tbody> <tr> <td>very dissatisfied</td> <td>0%</td> </tr> <tr> <td>quite dissatisfied</td> <td>16,67%</td> </tr> <tr> <td>neither satisfied or dissatisfied</td> <td>16,67%</td> </tr> <tr> <td>quite satisfied</td> <td>33,33%</td> </tr> <tr> <td>very satisfied</td> <td>33,33%</td> </tr> </tbody> </table>	Satisfaction Level	Percentage	very dissatisfied	0%	quite dissatisfied	16,67%	neither satisfied or dissatisfied	16,67%	quite satisfied	33,33%	very satisfied	33,33%		<p>During non-peak hours, there are more passengers that are dissatisfied with the seating capacity in the airport. This can be due to the fact that they arrived earlier (when the check-in desks were not open yet) and they had to wait outside the gate.</p>
Satisfaction Level	Percentage													
very dissatisfied	0%													
quite dissatisfied	16,67%													
neither satisfied or dissatisfied	16,67%													
quite satisfied	33,33%													
very satisfied	33,33%													
<p>Total seating capacity at the airport (women-non-peak)</p>  <table border="1"> <caption>Satisfaction levels for women during non-peak hours</caption> <thead> <tr> <th>Satisfaction Level</th> <th>Percentage</th> </tr> </thead> <tbody> <tr> <td>very dissatisfied</td> <td>0%</td> </tr> <tr> <td>quite dissatisfied</td> <td>0%</td> </tr> <tr> <td>neither satisfied or dissatisfied</td> <td>25,00%</td> </tr> <tr> <td>quite satisfied</td> <td>0%</td> </tr> <tr> <td>very satisfied</td> <td>75,00%</td> </tr> </tbody> </table>	Satisfaction Level	Percentage	very dissatisfied	0%	quite dissatisfied	0%	neither satisfied or dissatisfied	25,00%	quite satisfied	0%	very satisfied	75,00%		
Satisfaction Level	Percentage													
very dissatisfied	0%													
quite dissatisfied	0%													
neither satisfied or dissatisfied	25,00%													
quite satisfied	0%													
very satisfied	75,00%													

Figure 6.391 & Figure 6.392 Satisfaction of men and women with the total seating capacity at the airport (during non-peak hours) Source: Own composition, based on the responses to question 18 of the Customer survey WP5, version Antwerp Airport

During peak hours																
<p>Access to trolleys (men-peak)</p> <table border="1"> <caption>Access to trolleys (men-peak) Data</caption> <thead> <tr> <th>Satisfaction Level</th> <th>Percentage</th> </tr> </thead> <tbody> <tr> <td>very dissatisfied</td> <td>0%</td> </tr> <tr> <td>quite dissatisfied</td> <td>0%</td> </tr> <tr> <td>neither satisfied or dissatisfied</td> <td>0%</td> </tr> <tr> <td>quite satisfied</td> <td>11,11%</td> </tr> <tr> <td>very satisfied</td> <td>16,67%</td> </tr> <tr> <td>do not know</td> <td>72,22%</td> </tr> </tbody> </table>	Satisfaction Level	Percentage	very dissatisfied	0%	quite dissatisfied	0%	neither satisfied or dissatisfied	0%	quite satisfied	11,11%	very satisfied	16,67%	do not know	72,22%		<p>Most of the passengers do not need trolleys, either thanks to travelling without baggage or the short walking distances. Travellers who do use trolleys, are satisfied with them.</p>
Satisfaction Level	Percentage															
very dissatisfied	0%															
quite dissatisfied	0%															
neither satisfied or dissatisfied	0%															
quite satisfied	11,11%															
very satisfied	16,67%															
do not know	72,22%															
<p>Access to trolleys (women-peak)</p> <table border="1"> <caption>Access to trolleys (women-peak) Data</caption> <thead> <tr> <th>Satisfaction Level</th> <th>Percentage</th> </tr> </thead> <tbody> <tr> <td>very dissatisfied</td> <td>0%</td> </tr> <tr> <td>quite dissatisfied</td> <td>0%</td> </tr> <tr> <td>neither satisfied or dissatisfied</td> <td>0%</td> </tr> <tr> <td>quite satisfied</td> <td>6,67%</td> </tr> <tr> <td>very satisfied</td> <td>53,33%</td> </tr> <tr> <td>do not know</td> <td>40,00%</td> </tr> </tbody> </table>	Satisfaction Level	Percentage	very dissatisfied	0%	quite dissatisfied	0%	neither satisfied or dissatisfied	0%	quite satisfied	6,67%	very satisfied	53,33%	do not know	40,00%		
Satisfaction Level	Percentage															
very dissatisfied	0%															
quite dissatisfied	0%															
neither satisfied or dissatisfied	0%															
quite satisfied	6,67%															
very satisfied	53,33%															
do not know	40,00%															

Figure 6.393 & Figure 6.394 Satisfaction of men and women with the access to trolleys (during peak hours)

Source: Own composition, based on the responses to question 18 of the Customer survey WP5, version Antwerp Airport

During non-peak hours																
<p>Access to trolleys (men-non-peak)</p> <table border="1"> <caption>Access to trolleys (men-non-peak) Data</caption> <thead> <tr> <th>Satisfaction Level</th> <th>Percentage</th> </tr> </thead> <tbody> <tr> <td>very dissatisfied</td> <td>0%</td> </tr> <tr> <td>quite dissatisfied</td> <td>0%</td> </tr> <tr> <td>neither satisfied or dissatisfied</td> <td>0%</td> </tr> <tr> <td>quite satisfied</td> <td>0%</td> </tr> <tr> <td>very satisfied</td> <td>0%</td> </tr> <tr> <td>do not know</td> <td>100,00%</td> </tr> </tbody> </table>	Satisfaction Level	Percentage	very dissatisfied	0%	quite dissatisfied	0%	neither satisfied or dissatisfied	0%	quite satisfied	0%	very satisfied	0%	do not know	100,00%		<p>Most of the passengers do not need trolleys, either thanks to the travelling without baggage or the short walking distances. Travellers who do use trolleys, are satisfied with them.</p>
Satisfaction Level	Percentage															
very dissatisfied	0%															
quite dissatisfied	0%															
neither satisfied or dissatisfied	0%															
quite satisfied	0%															
very satisfied	0%															
do not know	100,00%															
<p>Access to trolleys (women-non-peak)</p> <table border="1"> <caption>Access to trolleys (women-non-peak) Data</caption> <thead> <tr> <th>Satisfaction Level</th> <th>Percentage</th> </tr> </thead> <tbody> <tr> <td>very dissatisfied</td> <td>0%</td> </tr> <tr> <td>quite dissatisfied</td> <td>0%</td> </tr> <tr> <td>neither satisfied or dissatisfied</td> <td>0%</td> </tr> <tr> <td>quite satisfied</td> <td>0%</td> </tr> <tr> <td>very satisfied</td> <td>25,00%</td> </tr> <tr> <td>do not know</td> <td>75,00%</td> </tr> </tbody> </table>	Satisfaction Level	Percentage	very dissatisfied	0%	quite dissatisfied	0%	neither satisfied or dissatisfied	0%	quite satisfied	0%	very satisfied	25,00%	do not know	75,00%		
Satisfaction Level	Percentage															
very dissatisfied	0%															
quite dissatisfied	0%															
neither satisfied or dissatisfied	0%															
quite satisfied	0%															
very satisfied	25,00%															
do not know	75,00%															

Figure 6.395 & Figure 6.396 Satisfaction of men and women with the access to trolleys (during non-peak hours) Source: Own composition, based on the responses to question 18 of the Customer survey WP5, version Antwerp Airport

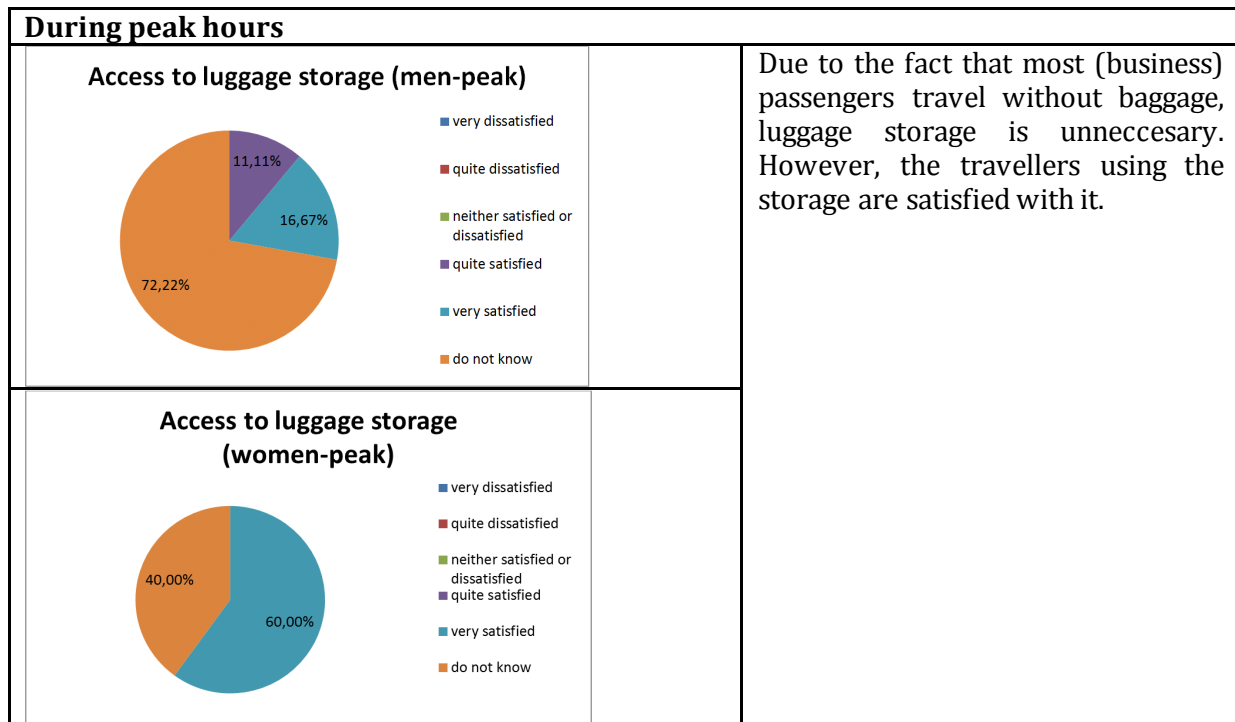


Figure 6.397 & Figure 6.398 Satisfaction of men and women with the access to luggage storage (during peak hours) Source: Own composition, based on the responses to question 18 of the Customer survey WP5, version Antwerp Airport

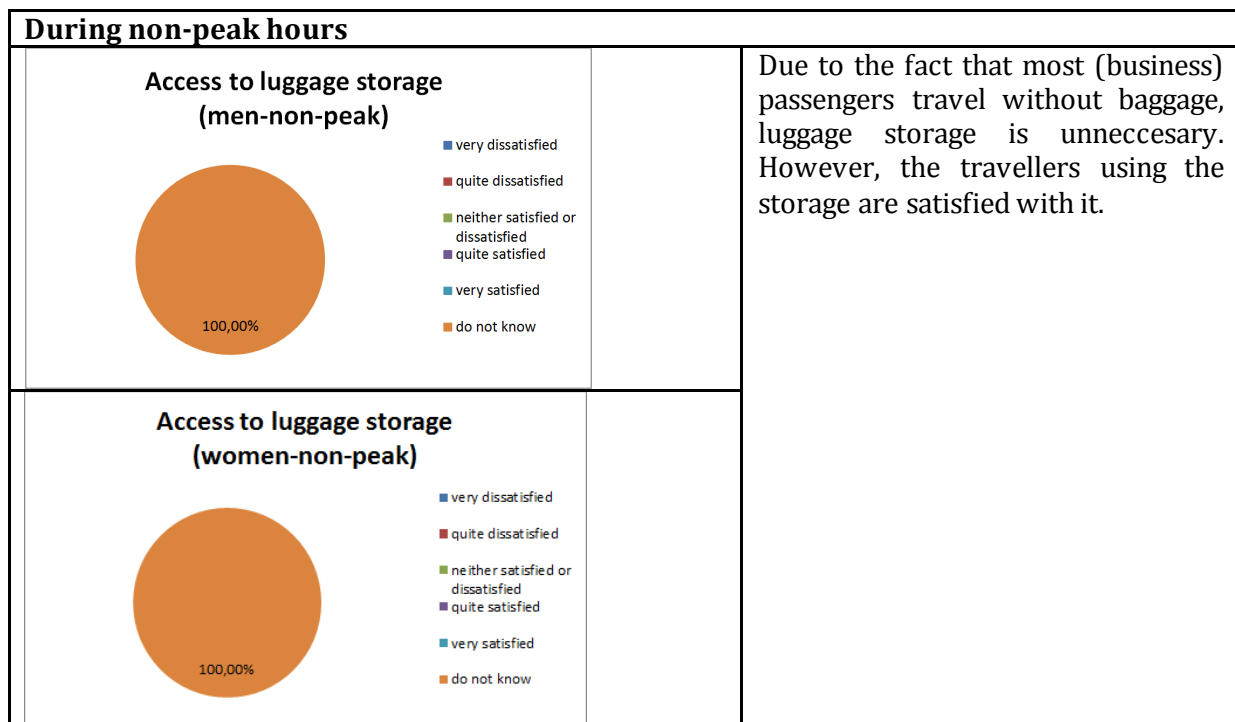


Figure 6.399 & Figure 6.400 Satisfaction of men and women with the access to luggage storage (during non-peak hours) Source: Own composition, based on the responses to question 18 of the Customer survey WP5, version Antwerp Airport

6.7.7.4.3 Distance

Since the airport building is rather small, the walking distances are short. At Antwerp Airport, every passenger area is on the ground floor and the doors are wide enough, so the airport is perfectly accessible for passengers with disabilities. Most of the respondents also stated that they are satisfied with the space at the airport.

6.7.7.4.4 Facilities at the site

Looking at the facilities at the site, the respondents indicated that there were plenty of seats at the gate, but that there are rather few seats in the rest of the airport building. Thanks to the short check-in time, however, these seats are not that necessary. Trolleys and storage for luggage are available and the passengers are satisfied with it, but the majority of the travellers do not need trolleys nor storage.

6.7.7.5 *Information, Ticketing and Check-in Services*

The quality of information desks, signs, ticketing and check-in counters at the airport are described in this section.

6.7.7.5.1 Observation

As already stated in the previous sections, Antwerp Airport is a rather small airport with short walking distances. This makes an abundance of information signs as well as information counters unnecessary. There are clear and accurate signs leading the way and there is personnel available to answer questions, but most of the passengers do not need them. Due to the fact that the majority of the passengers travel without luggage, also assistance with lost or delayed luggage is not very much needed, but it is available. Given that most travellers come by car or taxi, information about alternative transport modes is unnecessary.

The possibility to reschedule tickets is dependent on what sort of ticket the traveller owns. CityJet, the carrier at Antwerp Airport, offers two travel classes; CityPlus and CityValue. CityValue is the economy class ticket and CityPlus offers a bit more: it is a flexible ticket, which can be rescheduled without costs.

6.7.7.5.2 Passenger satisfaction - Survey

During peak hours																
<p>Number of information signs (men-peak)</p> <table border="1"> <caption>Men-peak satisfaction data</caption> <thead> <tr> <th>Satisfaction Level</th> <th>Percentage</th> </tr> </thead> <tbody> <tr> <td>very dissatisfied</td> <td>0%</td> </tr> <tr> <td>quite dissatisfied</td> <td>0%</td> </tr> <tr> <td>neither satisfied or dissatisfied</td> <td>0%</td> </tr> <tr> <td>quite satisfied</td> <td>33,33%</td> </tr> <tr> <td>very satisfied</td> <td>61,11%</td> </tr> <tr> <td>do not know</td> <td>5,56%</td> </tr> </tbody> </table>	Satisfaction Level	Percentage	very dissatisfied	0%	quite dissatisfied	0%	neither satisfied or dissatisfied	0%	quite satisfied	33,33%	very satisfied	61,11%	do not know	5,56%		<p>Most passengers during peak hours are satisfied with the information signs present at the airport.</p>
Satisfaction Level	Percentage															
very dissatisfied	0%															
quite dissatisfied	0%															
neither satisfied or dissatisfied	0%															
quite satisfied	33,33%															
very satisfied	61,11%															
do not know	5,56%															
<p>Number of information signs (women-peak)</p> <table border="1"> <caption>Women-peak satisfaction data</caption> <thead> <tr> <th>Satisfaction Level</th> <th>Percentage</th> </tr> </thead> <tbody> <tr> <td>very dissatisfied</td> <td>0%</td> </tr> <tr> <td>quite dissatisfied</td> <td>0%</td> </tr> <tr> <td>neither satisfied or dissatisfied</td> <td>0%</td> </tr> <tr> <td>quite satisfied</td> <td>40,00%</td> </tr> <tr> <td>very satisfied</td> <td>60,00%</td> </tr> </tbody> </table>	Satisfaction Level	Percentage	very dissatisfied	0%	quite dissatisfied	0%	neither satisfied or dissatisfied	0%	quite satisfied	40,00%	very satisfied	60,00%				
Satisfaction Level	Percentage															
very dissatisfied	0%															
quite dissatisfied	0%															
neither satisfied or dissatisfied	0%															
quite satisfied	40,00%															
very satisfied	60,00%															

Figure 6.401 & Figure 6.402 Satisfaction of men and women with the number of information signs (during peak hours) Source: Own composition, based on the responses to question 19 of the Customer survey WP5, version Antwerp Airport

During non-peak hours														
<p>Number of information signs (men-non-peak)</p> <table border="1"> <caption>Men-non-peak satisfaction data</caption> <thead> <tr> <th>Satisfaction Level</th> <th>Percentage</th> </tr> </thead> <tbody> <tr> <td>very dissatisfied</td> <td>0%</td> </tr> <tr> <td>quite dissatisfied</td> <td>0%</td> </tr> <tr> <td>neither satisfied or dissatisfied</td> <td>0%</td> </tr> <tr> <td>quite satisfied</td> <td>50,00%</td> </tr> <tr> <td>very satisfied</td> <td>50,00%</td> </tr> </tbody> </table>	Satisfaction Level	Percentage	very dissatisfied	0%	quite dissatisfied	0%	neither satisfied or dissatisfied	0%	quite satisfied	50,00%	very satisfied	50,00%		<p>Also during non-peak hours, travellers think that the number of information signs at the airport is sufficient.</p>
Satisfaction Level	Percentage													
very dissatisfied	0%													
quite dissatisfied	0%													
neither satisfied or dissatisfied	0%													
quite satisfied	50,00%													
very satisfied	50,00%													
<p>Number of information signs (women-non-peak)</p> <table border="1"> <caption>Women-non-peak satisfaction data</caption> <thead> <tr> <th>Satisfaction Level</th> <th>Percentage</th> </tr> </thead> <tbody> <tr> <td>very dissatisfied</td> <td>0%</td> </tr> <tr> <td>quite dissatisfied</td> <td>0%</td> </tr> <tr> <td>neither satisfied or dissatisfied</td> <td>0%</td> </tr> <tr> <td>quite satisfied</td> <td>0%</td> </tr> <tr> <td>very satisfied</td> <td>100,00%</td> </tr> </tbody> </table>	Satisfaction Level	Percentage	very dissatisfied	0%	quite dissatisfied	0%	neither satisfied or dissatisfied	0%	quite satisfied	0%	very satisfied	100,00%		
Satisfaction Level	Percentage													
very dissatisfied	0%													
quite dissatisfied	0%													
neither satisfied or dissatisfied	0%													
quite satisfied	0%													
very satisfied	100,00%													

Figure 6.403 & Figure 6.404 Satisfaction of men and women with the number of information signs (during non-peak hours) Source: Own composition, based on the responses to question 19 of the Customer survey WP5, version Antwerp Airport

During peak hours

<p>Clearness/accuracy of information (men-peak)</p> <table border="1"> <thead> <tr> <th>Satisfaction Level</th> <th>Percentage</th> </tr> </thead> <tbody> <tr> <td>very dissatisfied</td> <td>0%</td> </tr> <tr> <td>quite dissatisfied</td> <td>0%</td> </tr> <tr> <td>neither satisfied or dissatisfied</td> <td>0%</td> </tr> <tr> <td>quite satisfied</td> <td>22,22%</td> </tr> <tr> <td>very satisfied</td> <td>72,22%</td> </tr> <tr> <td>do not know</td> <td>5,56%</td> </tr> </tbody> </table>	Satisfaction Level	Percentage	very dissatisfied	0%	quite dissatisfied	0%	neither satisfied or dissatisfied	0%	quite satisfied	22,22%	very satisfied	72,22%	do not know	5,56%		<p>The information given on the information signs is clear and accurate.</p>
Satisfaction Level	Percentage															
very dissatisfied	0%															
quite dissatisfied	0%															
neither satisfied or dissatisfied	0%															
quite satisfied	22,22%															
very satisfied	72,22%															
do not know	5,56%															
<p>Clearness/accuracy of information (women-peak)</p> <table border="1"> <thead> <tr> <th>Satisfaction Level</th> <th>Percentage</th> </tr> </thead> <tbody> <tr> <td>very dissatisfied</td> <td>0%</td> </tr> <tr> <td>quite dissatisfied</td> <td>0%</td> </tr> <tr> <td>neither satisfied or dissatisfied</td> <td>0%</td> </tr> <tr> <td>quite satisfied</td> <td>13,33%</td> </tr> <tr> <td>very satisfied</td> <td>86,67%</td> </tr> </tbody> </table>	Satisfaction Level	Percentage	very dissatisfied	0%	quite dissatisfied	0%	neither satisfied or dissatisfied	0%	quite satisfied	13,33%	very satisfied	86,67%				
Satisfaction Level	Percentage															
very dissatisfied	0%															
quite dissatisfied	0%															
neither satisfied or dissatisfied	0%															
quite satisfied	13,33%															
very satisfied	86,67%															

Figure 6.405 & Figure 6.406 Satisfaction of men and women with the clearness/accuracy of the information signs (during peak hours) Source: Own composition, based on the responses to question 19 of the Customer survey WP5, version Antwerp Airport

<p>During non-peak hours</p>														
<p>Clearness/accuracy of information (men-non-peak)</p> <table border="1"> <thead> <tr> <th>Satisfaction Level</th> <th>Percentage</th> </tr> </thead> <tbody> <tr> <td>very dissatisfied</td> <td>0%</td> </tr> <tr> <td>quite dissatisfied</td> <td>0%</td> </tr> <tr> <td>neither satisfied or dissatisfied</td> <td>0%</td> </tr> <tr> <td>quite satisfied</td> <td>50,00%</td> </tr> <tr> <td>very satisfied</td> <td>50,00%</td> </tr> </tbody> </table>	Satisfaction Level	Percentage	very dissatisfied	0%	quite dissatisfied	0%	neither satisfied or dissatisfied	0%	quite satisfied	50,00%	very satisfied	50,00%		<p>The information given on the information signs is clear and accurate.</p>
Satisfaction Level	Percentage													
very dissatisfied	0%													
quite dissatisfied	0%													
neither satisfied or dissatisfied	0%													
quite satisfied	50,00%													
very satisfied	50,00%													
<p>Clearness/accuracy of information (women-non-peak)</p> <table border="1"> <thead> <tr> <th>Satisfaction Level</th> <th>Percentage</th> </tr> </thead> <tbody> <tr> <td>very dissatisfied</td> <td>0%</td> </tr> <tr> <td>quite dissatisfied</td> <td>0%</td> </tr> <tr> <td>neither satisfied or dissatisfied</td> <td>0%</td> </tr> <tr> <td>quite satisfied</td> <td>0%</td> </tr> <tr> <td>very satisfied</td> <td>100,00%</td> </tr> </tbody> </table>	Satisfaction Level	Percentage	very dissatisfied	0%	quite dissatisfied	0%	neither satisfied or dissatisfied	0%	quite satisfied	0%	very satisfied	100,00%		
Satisfaction Level	Percentage													
very dissatisfied	0%													
quite dissatisfied	0%													
neither satisfied or dissatisfied	0%													
quite satisfied	0%													
very satisfied	100,00%													

Figure 6.407 & Figure 6.408 Satisfaction of men and women with the clearness/accuracy of the information signs (during non-peak hours) Source: Own composition, based on the responses to question 19 of the Customer survey WP5, version Antwerp Airport

During peak hours

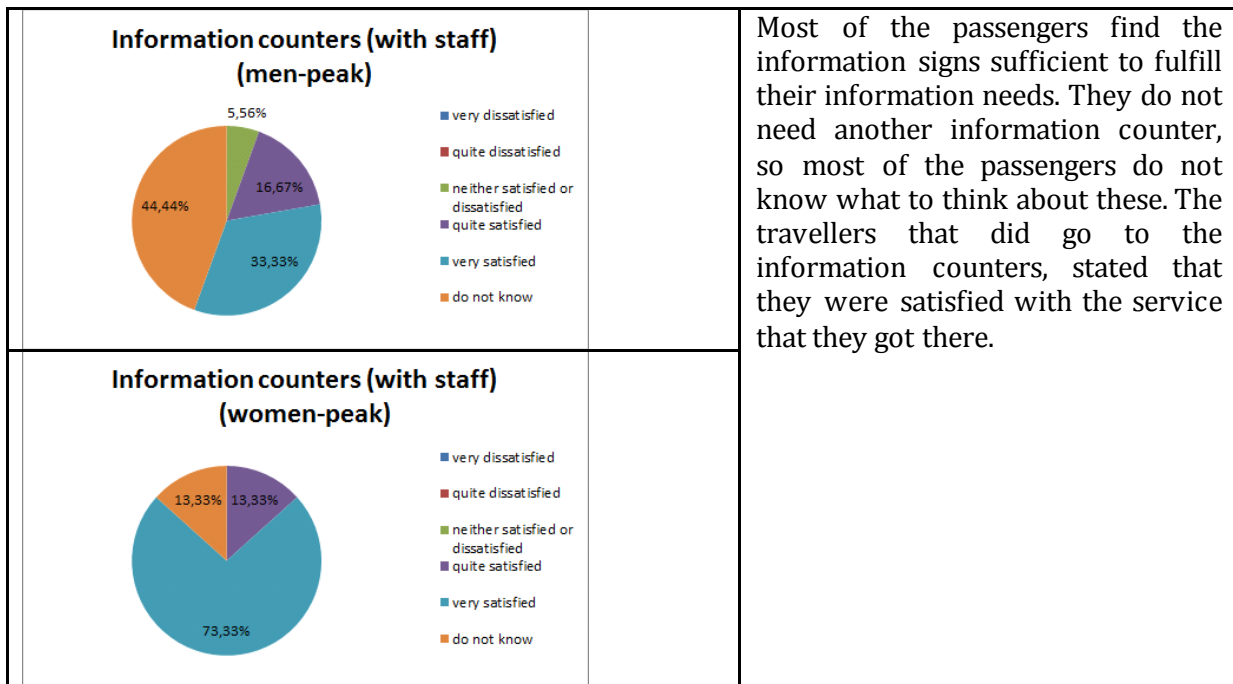


Figure 6.409 & Figure 6.410 Satisfaction of men and women with the information counters with staff (during peak hours) Source: Own composition, based on the responses to question 19 of the Customer survey WP5, version Antwerp Airport

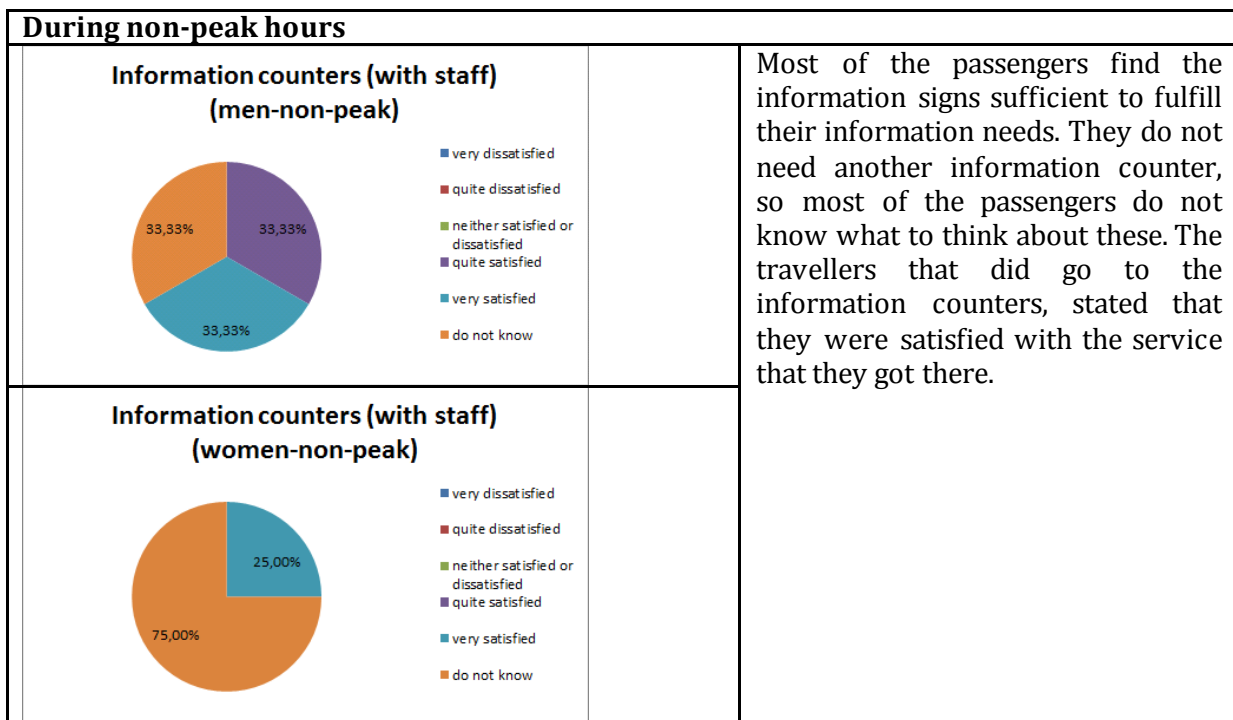


Figure 6.411 & Figure 6.412 Satisfaction of men and women with the information counters with staff (during non-peak hours) Source: Own composition, based on the responses to question 19 of the Customer survey WP5, version Antwerp Airport

During peak hours																
<p>Personells service at ticket counters (men-peak)</p> <table border="1"> <caption>Personells service at ticket counters (men-peak)</caption> <thead> <tr> <th>Satisfaction Level</th> <th>Percentage</th> </tr> </thead> <tbody> <tr> <td>very dissatisfied</td> <td>0%</td> </tr> <tr> <td>quite dissatisfied</td> <td>0%</td> </tr> <tr> <td>neither satisfied or dissatisfied</td> <td>0%</td> </tr> <tr> <td>quite satisfied</td> <td>22,22%</td> </tr> <tr> <td>very satisfied</td> <td>50,00%</td> </tr> <tr> <td>do not know</td> <td>27,78%</td> </tr> </tbody> </table>	Satisfaction Level	Percentage	very dissatisfied	0%	quite dissatisfied	0%	neither satisfied or dissatisfied	0%	quite satisfied	22,22%	very satisfied	50,00%	do not know	27,78%		<p>Some passengers bought their ticket online, so they were in no need of a ticket desk. However, passengers that did buy tickets at the airport were quite to very satisfied.</p>
Satisfaction Level	Percentage															
very dissatisfied	0%															
quite dissatisfied	0%															
neither satisfied or dissatisfied	0%															
quite satisfied	22,22%															
very satisfied	50,00%															
do not know	27,78%															
<p>Personells service at ticket counters (women-peak)</p> <table border="1"> <caption>Personells service at ticket counters (women-peak)</caption> <thead> <tr> <th>Satisfaction Level</th> <th>Percentage</th> </tr> </thead> <tbody> <tr> <td>very dissatisfied</td> <td>0%</td> </tr> <tr> <td>quite dissatisfied</td> <td>0%</td> </tr> <tr> <td>neither satisfied or dissatisfied</td> <td>0%</td> </tr> <tr> <td>quite satisfied</td> <td>0%</td> </tr> <tr> <td>very satisfied</td> <td>80,00%</td> </tr> <tr> <td>do not know</td> <td>20,00%</td> </tr> </tbody> </table>	Satisfaction Level	Percentage	very dissatisfied	0%	quite dissatisfied	0%	neither satisfied or dissatisfied	0%	quite satisfied	0%	very satisfied	80,00%	do not know	20,00%		
Satisfaction Level	Percentage															
very dissatisfied	0%															
quite dissatisfied	0%															
neither satisfied or dissatisfied	0%															
quite satisfied	0%															
very satisfied	80,00%															
do not know	20,00%															

Figure 6.413 & Figure 6.414 Satisfaction of men and women with the personnel’s service at the ticket counters (during peak hours) Source: Own composition, based on the responses to question 19 of the Customer survey WP5, version Antwerp Airport

During non-peak hours																
<p>Personells service at ticket counters (men-non-peak)</p> <table border="1"> <caption>Personells service at ticket counters (men-non-peak)</caption> <thead> <tr> <th>Satisfaction Level</th> <th>Percentage</th> </tr> </thead> <tbody> <tr> <td>very dissatisfied</td> <td>0%</td> </tr> <tr> <td>quite dissatisfied</td> <td>0%</td> </tr> <tr> <td>neither satisfied or dissatisfied</td> <td>0%</td> </tr> <tr> <td>quite satisfied</td> <td>0%</td> </tr> <tr> <td>very satisfied</td> <td>66,67%</td> </tr> <tr> <td>do not know</td> <td>33,33%</td> </tr> </tbody> </table>	Satisfaction Level	Percentage	very dissatisfied	0%	quite dissatisfied	0%	neither satisfied or dissatisfied	0%	quite satisfied	0%	very satisfied	66,67%	do not know	33,33%		<p>Some passengers bought their ticket online, so they were in no need of a ticket desk. However, passengers that did buy tickets at the airport were quite to very satisfied.</p>
Satisfaction Level	Percentage															
very dissatisfied	0%															
quite dissatisfied	0%															
neither satisfied or dissatisfied	0%															
quite satisfied	0%															
very satisfied	66,67%															
do not know	33,33%															
<p>Personells service at ticket counters (women-non-peak)</p> <table border="1"> <caption>Personells service at ticket counters (women-non-peak)</caption> <thead> <tr> <th>Satisfaction Level</th> <th>Percentage</th> </tr> </thead> <tbody> <tr> <td>very dissatisfied</td> <td>0%</td> </tr> <tr> <td>quite dissatisfied</td> <td>0%</td> </tr> <tr> <td>neither satisfied or dissatisfied</td> <td>0%</td> </tr> <tr> <td>quite satisfied</td> <td>0%</td> </tr> <tr> <td>very satisfied</td> <td>0%</td> </tr> <tr> <td>do not know</td> <td>100,00%</td> </tr> </tbody> </table>	Satisfaction Level	Percentage	very dissatisfied	0%	quite dissatisfied	0%	neither satisfied or dissatisfied	0%	quite satisfied	0%	very satisfied	0%	do not know	100,00%		
Satisfaction Level	Percentage															
very dissatisfied	0%															
quite dissatisfied	0%															
neither satisfied or dissatisfied	0%															
quite satisfied	0%															
very satisfied	0%															
do not know	100,00%															

Figure 6.415 & Figure 6.416 Satisfaction of men and women with the personnel’s service at the ticket counters (during non-peak hours) Source: Own composition, based on the responses to question 19 of the Customer survey WP5, version Antwerp Airport

During peak hours																
<p>Availability to reschedule tickets (men-peak)</p> <table border="1"> <caption>Availability to reschedule tickets (men-peak)</caption> <thead> <tr> <th>Satisfaction Level</th> <th>Percentage</th> </tr> </thead> <tbody> <tr> <td>very dissatisfied</td> <td>5,56%</td> </tr> <tr> <td>quite dissatisfied</td> <td>5,56%</td> </tr> <tr> <td>neither satisfied or dissatisfied</td> <td>22,22%</td> </tr> <tr> <td>quite satisfied</td> <td>5,56%</td> </tr> <tr> <td>very satisfied</td> <td>5,56%</td> </tr> <tr> <td>do not know</td> <td>61,11%</td> </tr> </tbody> </table>	Satisfaction Level	Percentage	very dissatisfied	5,56%	quite dissatisfied	5,56%	neither satisfied or dissatisfied	22,22%	quite satisfied	5,56%	very satisfied	5,56%	do not know	61,11%		<p>Not all travellers are satisfied with the availability of services to reschedule their ticket. However, this is not directly linked to the airport: the possibility to reschedule is related to the sort of ticket the traveller owns.</p> <p>Still, most of the respondents did not need to reschedule. Some were happy with the possibilities offered, other had no real opinion and only a few were dissatisfied.</p>
Satisfaction Level	Percentage															
very dissatisfied	5,56%															
quite dissatisfied	5,56%															
neither satisfied or dissatisfied	22,22%															
quite satisfied	5,56%															
very satisfied	5,56%															
do not know	61,11%															
<p>Availability to reschedule tickets (women-peak)</p> <table border="1"> <caption>Availability to reschedule tickets (women-peak)</caption> <thead> <tr> <th>Satisfaction Level</th> <th>Percentage</th> </tr> </thead> <tbody> <tr> <td>very dissatisfied</td> <td>6,67%</td> </tr> <tr> <td>quite dissatisfied</td> <td>0,00%</td> </tr> <tr> <td>neither satisfied or dissatisfied</td> <td>13,33%</td> </tr> <tr> <td>quite satisfied</td> <td>6,67%</td> </tr> <tr> <td>very satisfied</td> <td>33,33%</td> </tr> <tr> <td>do not know</td> <td>40,00%</td> </tr> </tbody> </table>	Satisfaction Level	Percentage	very dissatisfied	6,67%	quite dissatisfied	0,00%	neither satisfied or dissatisfied	13,33%	quite satisfied	6,67%	very satisfied	33,33%	do not know	40,00%		
Satisfaction Level	Percentage															
very dissatisfied	6,67%															
quite dissatisfied	0,00%															
neither satisfied or dissatisfied	13,33%															
quite satisfied	6,67%															
very satisfied	33,33%															
do not know	40,00%															

Figure 6.417 & Figure 6.418 Satisfaction of men and women with the availability to reschedule tickets (during peak hours) Source: Own composition, based on the responses to question 19 of the Customer survey WP5, version Antwerp Airport

During non-peak hours																
<p>Availability to reschedule tickets (men-non-peak)</p> <table border="1"> <caption>Availability to reschedule tickets (men-non-peak)</caption> <thead> <tr> <th>Satisfaction Level</th> <th>Percentage</th> </tr> </thead> <tbody> <tr> <td>very dissatisfied</td> <td>0,00%</td> </tr> <tr> <td>quite dissatisfied</td> <td>0,00%</td> </tr> <tr> <td>neither satisfied or dissatisfied</td> <td>0,00%</td> </tr> <tr> <td>quite satisfied</td> <td>0,00%</td> </tr> <tr> <td>very satisfied</td> <td>0,00%</td> </tr> <tr> <td>do not know</td> <td>100,00%</td> </tr> </tbody> </table>	Satisfaction Level	Percentage	very dissatisfied	0,00%	quite dissatisfied	0,00%	neither satisfied or dissatisfied	0,00%	quite satisfied	0,00%	very satisfied	0,00%	do not know	100,00%		<p>None of the non-peak travellers had to reschedule their ticket.</p>
Satisfaction Level	Percentage															
very dissatisfied	0,00%															
quite dissatisfied	0,00%															
neither satisfied or dissatisfied	0,00%															
quite satisfied	0,00%															
very satisfied	0,00%															
do not know	100,00%															
<p>Availability to reschedule tickets (women-non-peak)</p> <table border="1"> <caption>Availability to reschedule tickets (women-non-peak)</caption> <thead> <tr> <th>Satisfaction Level</th> <th>Percentage</th> </tr> </thead> <tbody> <tr> <td>very dissatisfied</td> <td>0,00%</td> </tr> <tr> <td>quite dissatisfied</td> <td>0,00%</td> </tr> <tr> <td>neither satisfied or dissatisfied</td> <td>0,00%</td> </tr> <tr> <td>quite satisfied</td> <td>0,00%</td> </tr> <tr> <td>very satisfied</td> <td>0,00%</td> </tr> <tr> <td>do not know</td> <td>100,00%</td> </tr> </tbody> </table>	Satisfaction Level	Percentage	very dissatisfied	0,00%	quite dissatisfied	0,00%	neither satisfied or dissatisfied	0,00%	quite satisfied	0,00%	very satisfied	0,00%	do not know	100,00%		
Satisfaction Level	Percentage															
very dissatisfied	0,00%															
quite dissatisfied	0,00%															
neither satisfied or dissatisfied	0,00%															
quite satisfied	0,00%															
very satisfied	0,00%															
do not know	100,00%															

Figure 6.419 & Figure 6.420 Satisfaction of men and women with the availability to reschedule tickets (during non-peak hours) Source: Own composition, based on the responses to question 19 of the Customer survey WP5, version Antwerp Airport

During peak hours																
<p>Help with lost or delayed baggage (men-peak)</p> <table border="1"> <caption>Men-peak satisfaction data</caption> <thead> <tr> <th>Satisfaction Level</th> <th>Percentage</th> </tr> </thead> <tbody> <tr> <td>very dissatisfied</td> <td>5,56%</td> </tr> <tr> <td>quite dissatisfied</td> <td>0%</td> </tr> <tr> <td>neither satisfied or dissatisfied</td> <td>0%</td> </tr> <tr> <td>quite satisfied</td> <td>0%</td> </tr> <tr> <td>very satisfied</td> <td>11,11%</td> </tr> <tr> <td>do not know</td> <td>83,33%</td> </tr> </tbody> </table>	Satisfaction Level	Percentage	very dissatisfied	5,56%	quite dissatisfied	0%	neither satisfied or dissatisfied	0%	quite satisfied	0%	very satisfied	11,11%	do not know	83,33%		<p>Most of the travellers have no experience with lost or delayed baggage, probably due to the fact that most passengers travel without baggage. However, the ones that have experienced problems with their luggage, where satisfied with the help they got.</p>
Satisfaction Level	Percentage															
very dissatisfied	5,56%															
quite dissatisfied	0%															
neither satisfied or dissatisfied	0%															
quite satisfied	0%															
very satisfied	11,11%															
do not know	83,33%															
<p>Help with lost or delayed baggage (women-peak)</p> <table border="1"> <caption>Women-peak satisfaction data</caption> <thead> <tr> <th>Satisfaction Level</th> <th>Percentage</th> </tr> </thead> <tbody> <tr> <td>very dissatisfied</td> <td>6,67%</td> </tr> <tr> <td>quite dissatisfied</td> <td>0%</td> </tr> <tr> <td>neither satisfied or dissatisfied</td> <td>0%</td> </tr> <tr> <td>quite satisfied</td> <td>0%</td> </tr> <tr> <td>very satisfied</td> <td>20,00%</td> </tr> <tr> <td>do not know</td> <td>73,33%</td> </tr> </tbody> </table>	Satisfaction Level	Percentage	very dissatisfied	6,67%	quite dissatisfied	0%	neither satisfied or dissatisfied	0%	quite satisfied	0%	very satisfied	20,00%	do not know	73,33%		
Satisfaction Level	Percentage															
very dissatisfied	6,67%															
quite dissatisfied	0%															
neither satisfied or dissatisfied	0%															
quite satisfied	0%															
very satisfied	20,00%															
do not know	73,33%															

Figure 6.421 & Figure 6.422 Satisfaction of men and women with the help with lost or delayed baggage (during peak hours) Source: Own composition, based on the responses to question 19 of the Customer survey WP5, version Antwerp Airport

During non-peak hours																
<p>Help with lost or delayed baggage (men-non-peak)</p> <table border="1"> <caption>Men-non-peak satisfaction data</caption> <thead> <tr> <th>Satisfaction Level</th> <th>Percentage</th> </tr> </thead> <tbody> <tr> <td>very dissatisfied</td> <td>0%</td> </tr> <tr> <td>quite dissatisfied</td> <td>0%</td> </tr> <tr> <td>neither satisfied or dissatisfied</td> <td>0%</td> </tr> <tr> <td>quite satisfied</td> <td>0%</td> </tr> <tr> <td>very satisfied</td> <td>0%</td> </tr> <tr> <td>do not know</td> <td>100,00%</td> </tr> </tbody> </table>	Satisfaction Level	Percentage	very dissatisfied	0%	quite dissatisfied	0%	neither satisfied or dissatisfied	0%	quite satisfied	0%	very satisfied	0%	do not know	100,00%		<p>During non-peak hours, none of the respondents had experience with losing baggage or with delayed baggage.</p>
Satisfaction Level	Percentage															
very dissatisfied	0%															
quite dissatisfied	0%															
neither satisfied or dissatisfied	0%															
quite satisfied	0%															
very satisfied	0%															
do not know	100,00%															
<p>Help with lost or delayed baggage (women-non-peak)</p> <table border="1"> <caption>Women-non-peak satisfaction data</caption> <thead> <tr> <th>Satisfaction Level</th> <th>Percentage</th> </tr> </thead> <tbody> <tr> <td>very dissatisfied</td> <td>0%</td> </tr> <tr> <td>quite dissatisfied</td> <td>0%</td> </tr> <tr> <td>neither satisfied or dissatisfied</td> <td>0%</td> </tr> <tr> <td>quite satisfied</td> <td>0%</td> </tr> <tr> <td>very satisfied</td> <td>0%</td> </tr> <tr> <td>do not know</td> <td>100,00%</td> </tr> </tbody> </table>	Satisfaction Level	Percentage	very dissatisfied	0%	quite dissatisfied	0%	neither satisfied or dissatisfied	0%	quite satisfied	0%	very satisfied	0%	do not know	100,00%		
Satisfaction Level	Percentage															
very dissatisfied	0%															
quite dissatisfied	0%															
neither satisfied or dissatisfied	0%															
quite satisfied	0%															
very satisfied	0%															
do not know	100,00%															

Figure 6.423 & Figure 6.424 Satisfaction of men and women with the help with lost or delayed baggage (during non-peak hours) Source: Own composition, based on the responses to question 19 of the Customer survey WP5, version Antwerp Airport

The figures above indicate that the information services delivered at Antwerp Airport are good: there are enough signs and the information on those signs is clear and accurate. This makes information counters more or less unnecessary, but travellers who did go to the information counters, were satisfied with the service offered. Also ticket desks are not needed for some of the travellers since they bought their ticket online. However, the services at the ticket desks are found to be quite to very good. When it comes to rescheduling of the tickets, a lot of the passengers had no experience with it. There were a few passengers that were dissatisfied, but here it is important to stress that the rescheduling is not related to the airport, but to the ticket the traveller bought. Most of the passengers do not need help with their baggage, but the ones that have experience with lost or delayed baggage, were satisfied with the help they got.

6.7.7.6 *Added value at the site*

6.7.7.6.1 Observation

At the airport, there are also other facilities which give added value. These will be described in this section. Retail, lavatories and lounges are examples of such facilities. Given the customers of Antwerp Airport, a business lounge is available at the site. Due to the limited check-in time however, the lounge is not that frequently used. Also retail is limited to one small airport shop which sells magazines, cigarettes, drinks, ... Furthermore, there are plenty of lavatories in the airport building: 2 "lavatory rooms" (with about 6 lavatories) before security controls and another "lavatory room" at the gate. During the time that the survey was performed, cleaning ladies were busy with cleaning the airport building.

6.7.7.6.2 Passenger satisfaction - Survey

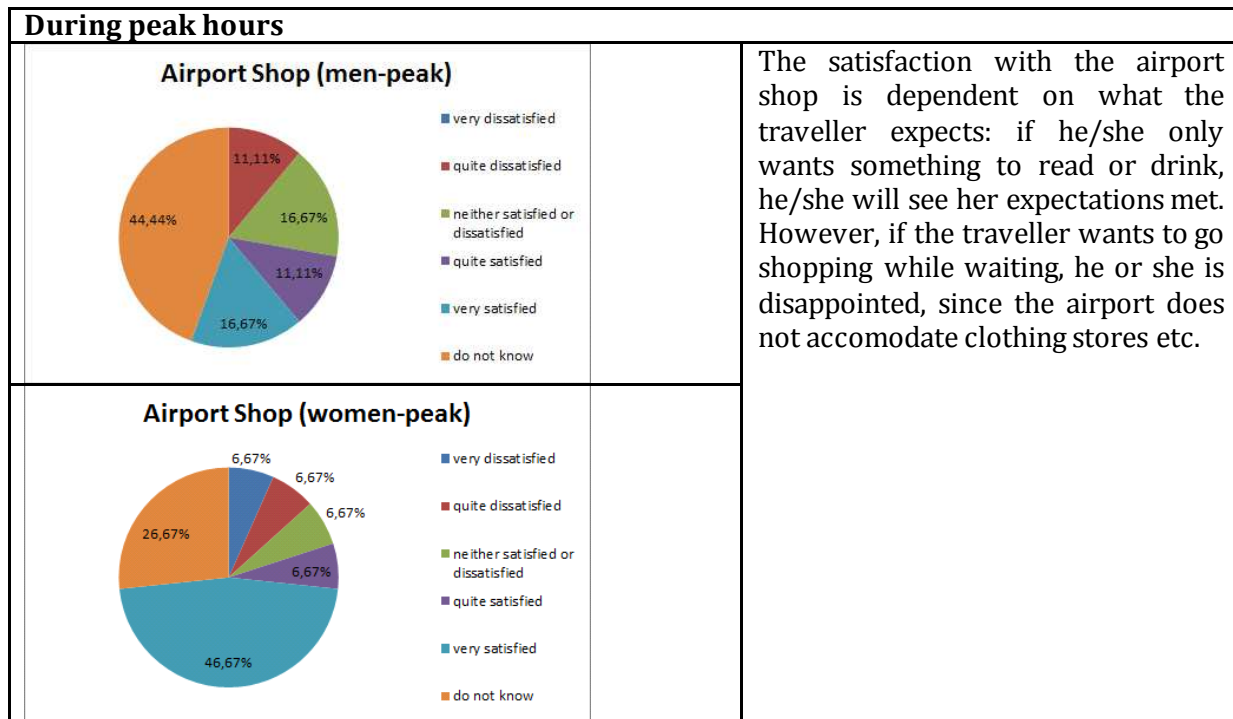


Figure 6.425 & Figure 6.426 Satisfaction of men and women with the airport shop (during peak hours)

Source: Own composition, based on the responses to question 22 of the Customer survey WP5, version Antwerp Airport

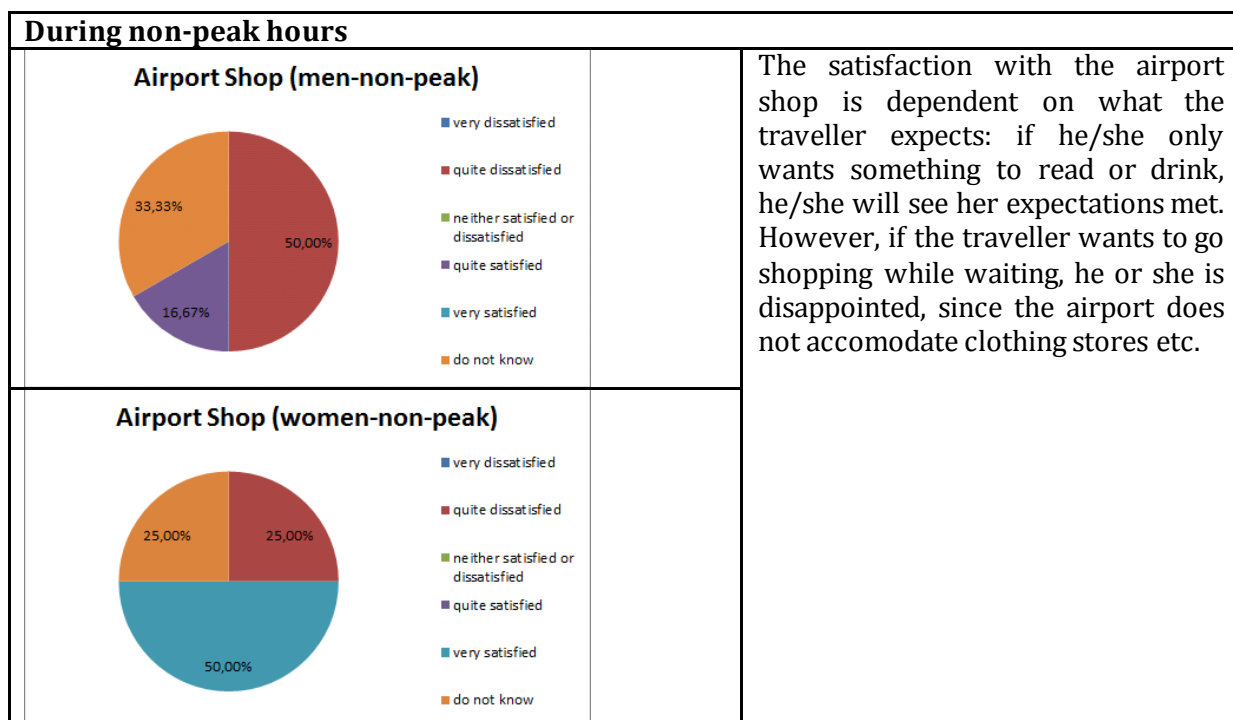


Figure 6.427 & Figure 6.428 Satisfaction of men and women with the airport shop (during non-peak hours)

Source: Own composition, based on the responses to question 22 of the Customer survey WP5, version Antwerp Airport

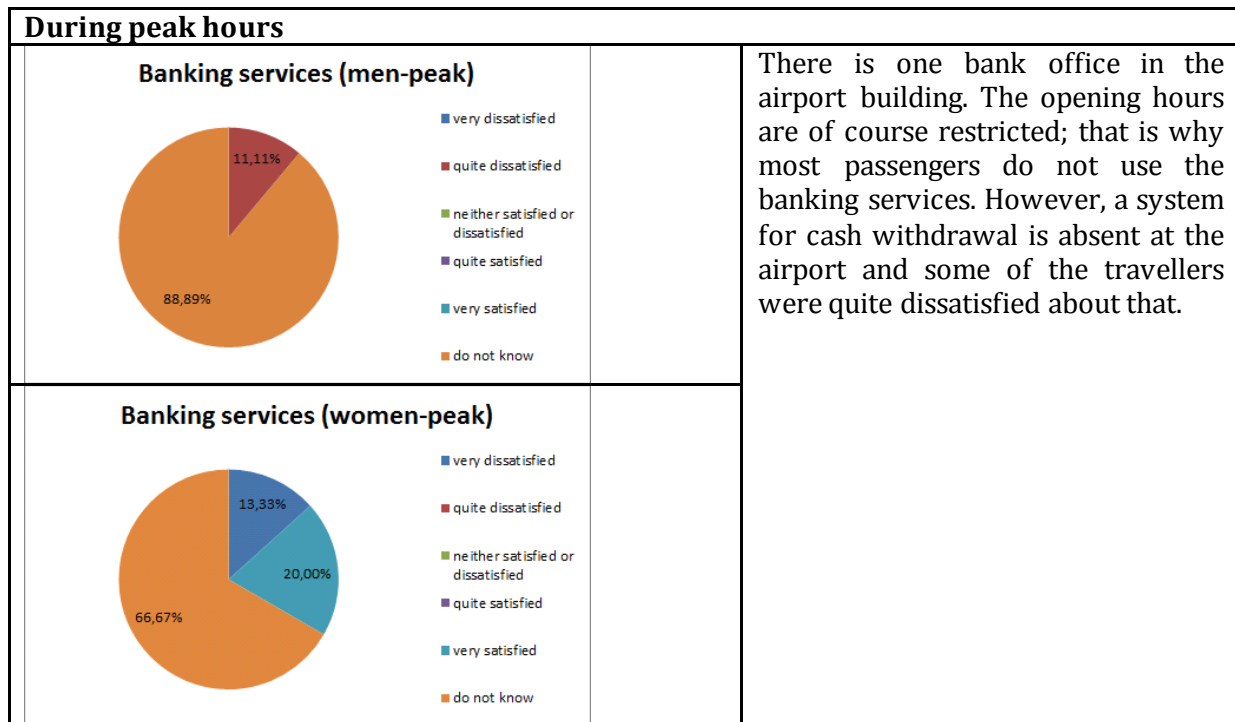


Figure 6.429 & Figure 6.430 Satisfaction of men and women with the banking services (during peak hours)

Source: Own composition, based on the responses to question 22 of the Customer survey WP5, version Antwerp Airport

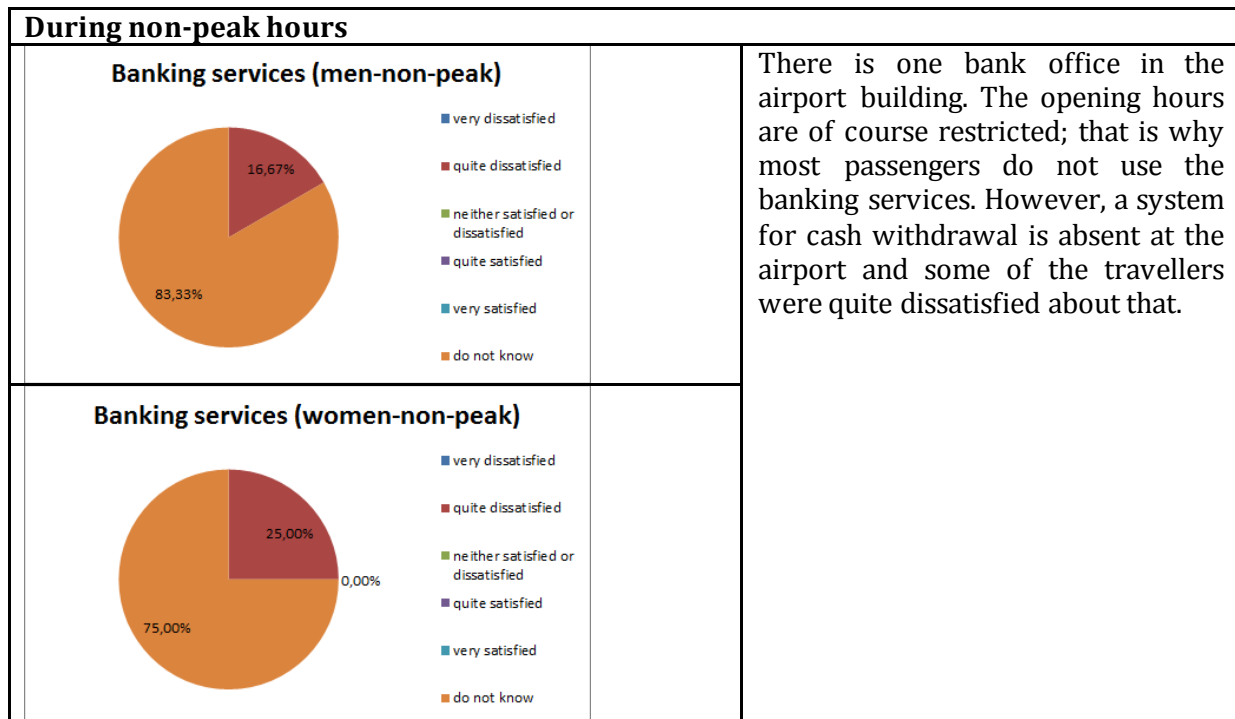


Figure 6.431 & Figure 6.432 Satisfaction of men and women with the banking services (during non-peak hours) Source: Own composition, based on the responses to question 22 of the Customer survey WP5, version Antwerp Airport

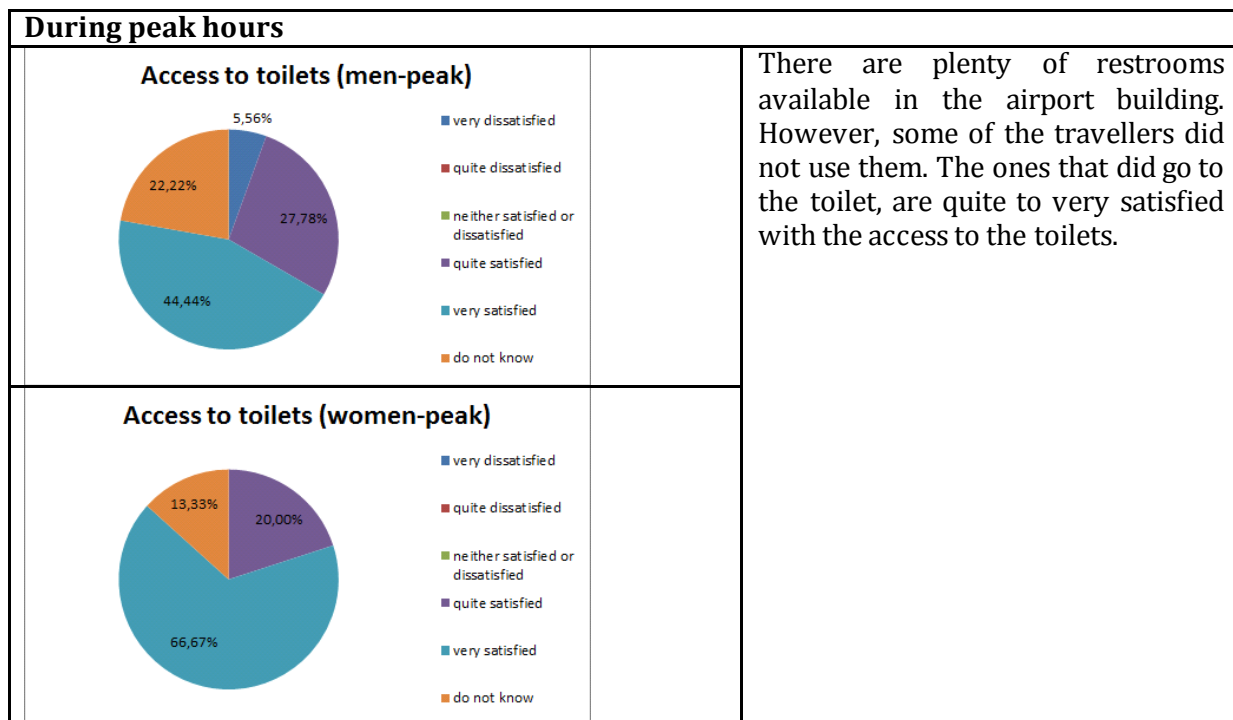


Figure 6.433 & Figure 6.434 Satisfaction of men and women with the access to toilets (during peak hours)

Source: Own composition, based on the responses to question 22 of the Customer survey WP5, version Antwerp Airport

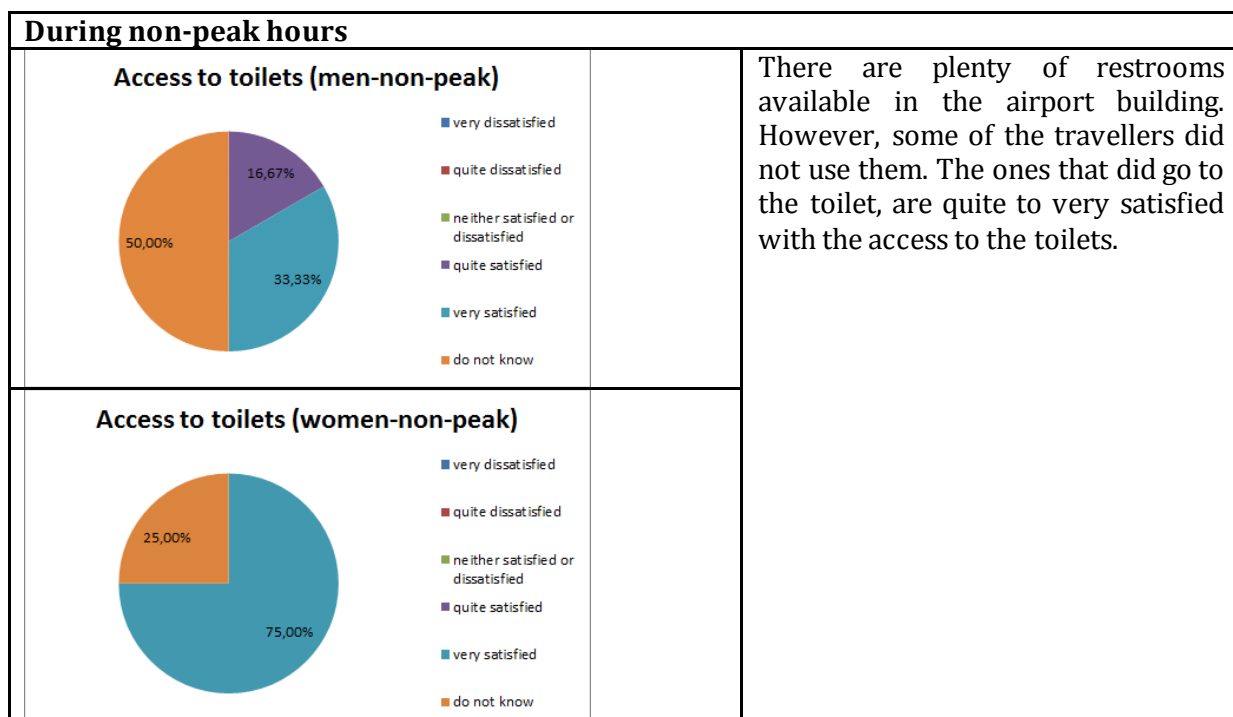


Figure 6.435 & Figure 6.436 Satisfaction of men and women with the access to toilets (during non-peak hours) Source: Own composition, based on the responses to question 22 of the Customer survey WP5, version Antwerp Airport

During peak hours																
<p>Access to the Internet (men-peak)</p> <table border="1"> <caption>Access to the Internet (men-peak)</caption> <thead> <tr> <th>Satisfaction Level</th> <th>Percentage</th> </tr> </thead> <tbody> <tr> <td>very dissatisfied</td> <td>5,56%</td> </tr> <tr> <td>quite dissatisfied</td> <td>5,56%</td> </tr> <tr> <td>neither satisfied or dissatisfied</td> <td>11,11%</td> </tr> <tr> <td>quite satisfied</td> <td>5,56%</td> </tr> <tr> <td>very satisfied</td> <td>11,11%</td> </tr> <tr> <td>do not know</td> <td>66,67%</td> </tr> </tbody> </table>	Satisfaction Level	Percentage	very dissatisfied	5,56%	quite dissatisfied	5,56%	neither satisfied or dissatisfied	11,11%	quite satisfied	5,56%	very satisfied	11,11%	do not know	66,67%		<p>Due to the limited waiting time, most of the passengers are in no need of internet access. There is a hotspot available, but it is not free so this is why some of the travellers are dissatisfied.</p>
Satisfaction Level	Percentage															
very dissatisfied	5,56%															
quite dissatisfied	5,56%															
neither satisfied or dissatisfied	11,11%															
quite satisfied	5,56%															
very satisfied	11,11%															
do not know	66,67%															
<p>Access to the Internet (women-peak)</p> <table border="1"> <caption>Access to the Internet (women-peak)</caption> <thead> <tr> <th>Satisfaction Level</th> <th>Percentage</th> </tr> </thead> <tbody> <tr> <td>very dissatisfied</td> <td>13,33%</td> </tr> <tr> <td>quite dissatisfied</td> <td>13,33%</td> </tr> <tr> <td>neither satisfied or dissatisfied</td> <td>13,33%</td> </tr> <tr> <td>quite satisfied</td> <td>13,33%</td> </tr> <tr> <td>very satisfied</td> <td>6,67%</td> </tr> <tr> <td>do not know</td> <td>66,67%</td> </tr> </tbody> </table>	Satisfaction Level	Percentage	very dissatisfied	13,33%	quite dissatisfied	13,33%	neither satisfied or dissatisfied	13,33%	quite satisfied	13,33%	very satisfied	6,67%	do not know	66,67%		
Satisfaction Level	Percentage															
very dissatisfied	13,33%															
quite dissatisfied	13,33%															
neither satisfied or dissatisfied	13,33%															
quite satisfied	13,33%															
very satisfied	6,67%															
do not know	66,67%															

Figure 6.437 & Figure 6.438 Satisfaction of men and women with the access to the Internet (during peak hours) Source: Own composition, based on the responses to question 22 of the Customer survey WP5, version Antwerp Airport

During non-peak hours																
<p>Access to the Internet (men-non-peak)</p> <table border="1"> <caption>Access to the Internet (men-non-peak)</caption> <thead> <tr> <th>Satisfaction Level</th> <th>Percentage</th> </tr> </thead> <tbody> <tr> <td>very dissatisfied</td> <td>0,00%</td> </tr> <tr> <td>quite dissatisfied</td> <td>0,00%</td> </tr> <tr> <td>neither satisfied or dissatisfied</td> <td>0,00%</td> </tr> <tr> <td>quite satisfied</td> <td>16,67%</td> </tr> <tr> <td>very satisfied</td> <td>0,00%</td> </tr> <tr> <td>do not know</td> <td>83,33%</td> </tr> </tbody> </table>	Satisfaction Level	Percentage	very dissatisfied	0,00%	quite dissatisfied	0,00%	neither satisfied or dissatisfied	0,00%	quite satisfied	16,67%	very satisfied	0,00%	do not know	83,33%		<p>Due to the limited waiting time, most of the passengers are in no need of internet access. There is a hotspot available, but it is not free so this is why some of the travellers are dissatisfied.</p>
Satisfaction Level	Percentage															
very dissatisfied	0,00%															
quite dissatisfied	0,00%															
neither satisfied or dissatisfied	0,00%															
quite satisfied	16,67%															
very satisfied	0,00%															
do not know	83,33%															
<p>Access to the Internet (women-non-peak)</p> <table border="1"> <caption>Access to the Internet (women-non-peak)</caption> <thead> <tr> <th>Satisfaction Level</th> <th>Percentage</th> </tr> </thead> <tbody> <tr> <td>very dissatisfied</td> <td>25,00%</td> </tr> <tr> <td>quite dissatisfied</td> <td>0,00%</td> </tr> <tr> <td>neither satisfied or dissatisfied</td> <td>0,00%</td> </tr> <tr> <td>quite satisfied</td> <td>0,00%</td> </tr> <tr> <td>very satisfied</td> <td>0,00%</td> </tr> <tr> <td>do not know</td> <td>75,00%</td> </tr> </tbody> </table>	Satisfaction Level	Percentage	very dissatisfied	25,00%	quite dissatisfied	0,00%	neither satisfied or dissatisfied	0,00%	quite satisfied	0,00%	very satisfied	0,00%	do not know	75,00%		
Satisfaction Level	Percentage															
very dissatisfied	25,00%															
quite dissatisfied	0,00%															
neither satisfied or dissatisfied	0,00%															
quite satisfied	0,00%															
very satisfied	0,00%															
do not know	75,00%															

Figure 6.439 & Figure 6.440 Satisfaction of men and women with the access to the Internet (during non-peak hours) Source: Own composition, based on the responses to question 22 of the Customer survey WP5, version Antwerp Airport

During peak hours														
<p>Access to work facilities (men-peak)</p> <table border="1"> <tr><td>very dissatisfied</td><td>5,56%</td></tr> <tr><td>quite dissatisfied</td><td>5,56%</td></tr> <tr><td>neither satisfied or dissatisfied</td><td>0%</td></tr> <tr><td>quite satisfied</td><td>0%</td></tr> <tr><td>very satisfied</td><td>0%</td></tr> <tr><td>do not know</td><td>88,89%</td></tr> </table>	very dissatisfied	5,56%	quite dissatisfied	5,56%	neither satisfied or dissatisfied	0%	quite satisfied	0%	very satisfied	0%	do not know	88,89%		<p>Given the 20 min.' check-in time, the waiting time is rather short, so the passengers do not need work facilities. However, if they would want to work, they have no room where they can quietly sit and work. Some passengers are dissatisfied with this.</p>
very dissatisfied	5,56%													
quite dissatisfied	5,56%													
neither satisfied or dissatisfied	0%													
quite satisfied	0%													
very satisfied	0%													
do not know	88,89%													
<p>Access to work facilities (women-peak)</p> <table border="1"> <tr><td>very dissatisfied</td><td>13,33%</td></tr> <tr><td>quite dissatisfied</td><td>6,67%</td></tr> <tr><td>neither satisfied or dissatisfied</td><td>0%</td></tr> <tr><td>quite satisfied</td><td>0%</td></tr> <tr><td>very satisfied</td><td>0%</td></tr> <tr><td>do not know</td><td>80,00%</td></tr> </table>	very dissatisfied	13,33%	quite dissatisfied	6,67%	neither satisfied or dissatisfied	0%	quite satisfied	0%	very satisfied	0%	do not know	80,00%		
very dissatisfied	13,33%													
quite dissatisfied	6,67%													
neither satisfied or dissatisfied	0%													
quite satisfied	0%													
very satisfied	0%													
do not know	80,00%													

Figure 6.441 & Figure 6.442 Satisfaction of men and women with the access to work facilities (during peak hours) Source: Own composition, based on the responses to question 22 of the Customer survey WP5, version Antwerp Airport

During non-peak hours														
<p>Access to work facilities (men-non-peak)</p> <table border="1"> <tr><td>very dissatisfied</td><td>0%</td></tr> <tr><td>quite dissatisfied</td><td>16,67%</td></tr> <tr><td>neither satisfied or dissatisfied</td><td>0%</td></tr> <tr><td>quite satisfied</td><td>0%</td></tr> <tr><td>very satisfied</td><td>0%</td></tr> <tr><td>do not know</td><td>83,33%</td></tr> </table>	very dissatisfied	0%	quite dissatisfied	16,67%	neither satisfied or dissatisfied	0%	quite satisfied	0%	very satisfied	0%	do not know	83,33%		<p>Given the 20 min.' check-in time, the waiting time is rather short, so the passengers do not need work facilities. However, if they would want to work, they have no room where they can quietly sit and work. Some passengers are dissatisfied with this.</p>
very dissatisfied	0%													
quite dissatisfied	16,67%													
neither satisfied or dissatisfied	0%													
quite satisfied	0%													
very satisfied	0%													
do not know	83,33%													
<p>Access to work facilities (women-non-peak)</p> <table border="1"> <tr><td>very dissatisfied</td><td>25,00%</td></tr> <tr><td>quite dissatisfied</td><td>0,00%</td></tr> <tr><td>neither satisfied or dissatisfied</td><td>0%</td></tr> <tr><td>quite satisfied</td><td>0%</td></tr> <tr><td>very satisfied</td><td>0%</td></tr> <tr><td>do not know</td><td>75,00%</td></tr> </table>	very dissatisfied	25,00%	quite dissatisfied	0,00%	neither satisfied or dissatisfied	0%	quite satisfied	0%	very satisfied	0%	do not know	75,00%		
very dissatisfied	25,00%													
quite dissatisfied	0,00%													
neither satisfied or dissatisfied	0%													
quite satisfied	0%													
very satisfied	0%													
do not know	75,00%													

Figure 6.443 & Figure 6.444 Satisfaction of men and women with the access to work facilities (during non-peak hours) Source: Own composition, based on the responses to question 22 of the Customer survey WP5, version Antwerp Airport

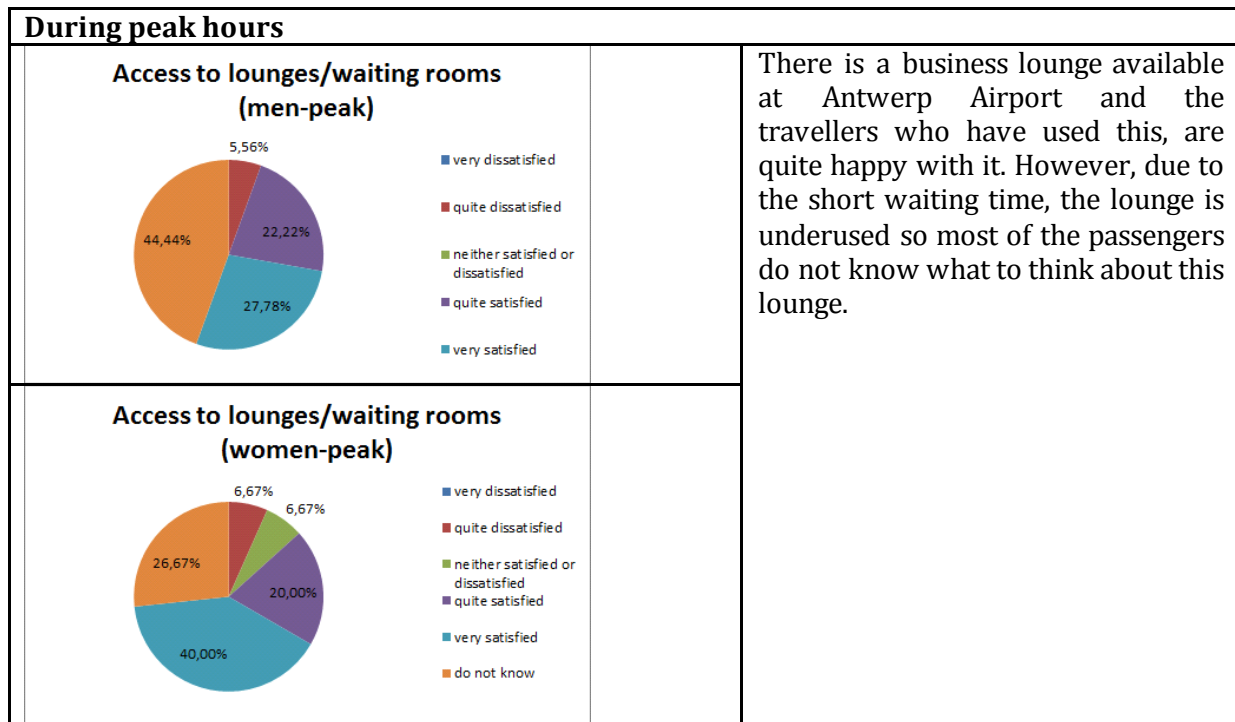


Figure 6.445 & Figure 6.446 Satisfaction of men and women with the access to lounges/waiting rooms (during peak hours) Source: Own composition, based on the responses to question 22 of the Customer survey WP5, version Antwerp Airport

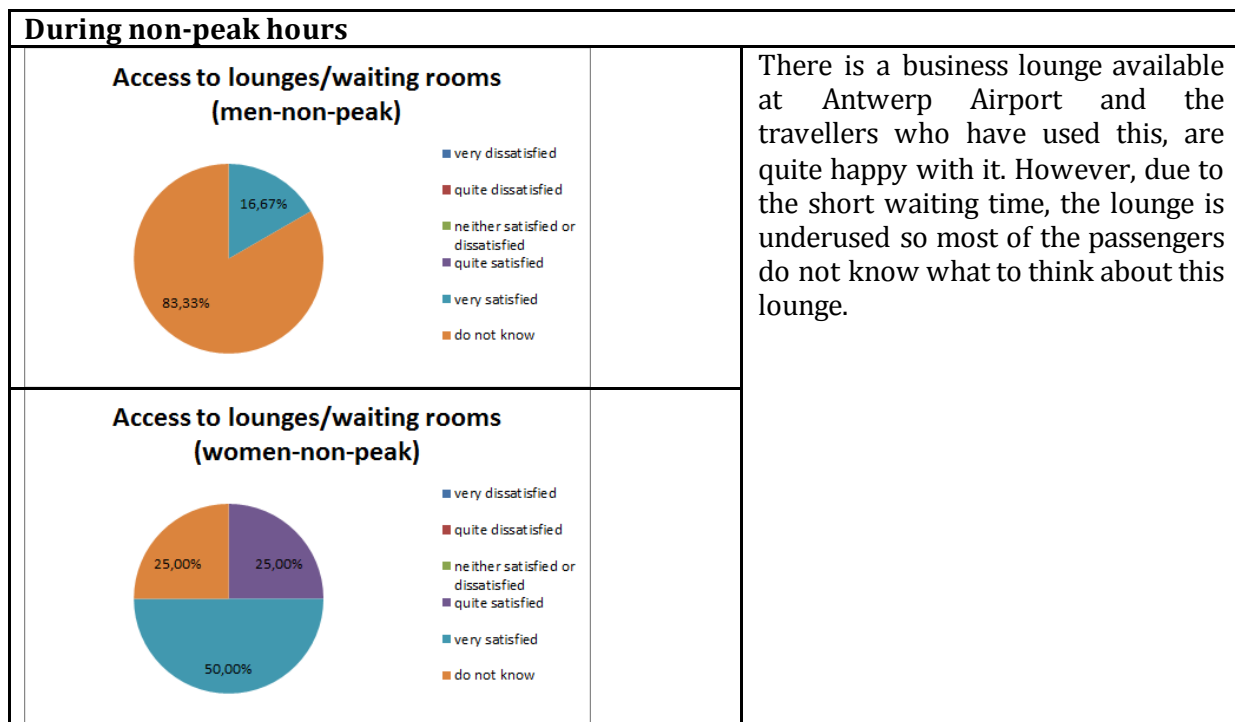


Figure 6.447 & Figure 6.448 Satisfaction of men and women with the access to lounges/waiting rooms (during non-peak hours) Source: Own composition, based on the responses to question 22 of the Customer survey WP5, version Antwerp Airport

During peak hours																
<p>Access to parking spaces (men-peak)</p> <table border="1"> <caption>Access to parking spaces (men-peak)</caption> <thead> <tr> <th>Satisfaction Level</th> <th>Percentage</th> </tr> </thead> <tbody> <tr> <td>very dissatisfied</td> <td>0.00%</td> </tr> <tr> <td>quite dissatisfied</td> <td>0.00%</td> </tr> <tr> <td>neither satisfied or dissatisfied</td> <td>0.00%</td> </tr> <tr> <td>quite satisfied</td> <td>5.56%</td> </tr> <tr> <td>very satisfied</td> <td>83.33%</td> </tr> <tr> <td>do not know</td> <td>11.11%</td> </tr> </tbody> </table>	Satisfaction Level	Percentage	very dissatisfied	0.00%	quite dissatisfied	0.00%	neither satisfied or dissatisfied	0.00%	quite satisfied	5.56%	very satisfied	83.33%	do not know	11.11%		<p>Error! Reference source not found. and 142 show that, thanks to the large, free parking lot in front of the airport building, most of the travellers are quite to very satisfied with the parking spaces. Some passengers were dissatisfied due to the fact that the parking lot is not guarded.</p>
Satisfaction Level	Percentage															
very dissatisfied	0.00%															
quite dissatisfied	0.00%															
neither satisfied or dissatisfied	0.00%															
quite satisfied	5.56%															
very satisfied	83.33%															
do not know	11.11%															
<p>Access to parking spaces (women-peak)</p> <table border="1"> <caption>Access to parking spaces (women-peak)</caption> <thead> <tr> <th>Satisfaction Level</th> <th>Percentage</th> </tr> </thead> <tbody> <tr> <td>very dissatisfied</td> <td>6.67%</td> </tr> <tr> <td>quite dissatisfied</td> <td>0.00%</td> </tr> <tr> <td>neither satisfied or dissatisfied</td> <td>0.00%</td> </tr> <tr> <td>quite satisfied</td> <td>20.00%</td> </tr> <tr> <td>very satisfied</td> <td>46.67%</td> </tr> <tr> <td>do not know</td> <td>26.67%</td> </tr> </tbody> </table>	Satisfaction Level	Percentage	very dissatisfied	6.67%	quite dissatisfied	0.00%	neither satisfied or dissatisfied	0.00%	quite satisfied	20.00%	very satisfied	46.67%	do not know	26.67%		
Satisfaction Level	Percentage															
very dissatisfied	6.67%															
quite dissatisfied	0.00%															
neither satisfied or dissatisfied	0.00%															
quite satisfied	20.00%															
very satisfied	46.67%															
do not know	26.67%															

Figure 6.449 & Figure 6.450 Satisfaction of men and women with the access to parking spaces (during peak hours) Source: Own composition, based on the responses to question 22 of the Customer survey WP5, version Antwerp Airport

During non-peak hours																
<p>Access to parking spaces (men-non-peak)</p> <table border="1"> <caption>Access to parking spaces (men-non-peak)</caption> <thead> <tr> <th>Satisfaction Level</th> <th>Percentage</th> </tr> </thead> <tbody> <tr> <td>very dissatisfied</td> <td>0.00%</td> </tr> <tr> <td>quite dissatisfied</td> <td>0.00%</td> </tr> <tr> <td>neither satisfied or dissatisfied</td> <td>0.00%</td> </tr> <tr> <td>quite satisfied</td> <td>16.67%</td> </tr> <tr> <td>very satisfied</td> <td>66.67%</td> </tr> <tr> <td>do not know</td> <td>16.67%</td> </tr> </tbody> </table>	Satisfaction Level	Percentage	very dissatisfied	0.00%	quite dissatisfied	0.00%	neither satisfied or dissatisfied	0.00%	quite satisfied	16.67%	very satisfied	66.67%	do not know	16.67%		<p>Thanks to the large, free parking lot in front of the airport building most of the travellers are quite to very satisfied with the parking spaces, as can be seen on Error! Reference source not found. and Graph 144. Some passengers were dissatisfied due to the fact that the parking lot is not guarded.</p>
Satisfaction Level	Percentage															
very dissatisfied	0.00%															
quite dissatisfied	0.00%															
neither satisfied or dissatisfied	0.00%															
quite satisfied	16.67%															
very satisfied	66.67%															
do not know	16.67%															
<p>Access to parking spaces (women-non-peak)</p> <table border="1"> <caption>Access to parking spaces (women-non-peak)</caption> <thead> <tr> <th>Satisfaction Level</th> <th>Percentage</th> </tr> </thead> <tbody> <tr> <td>very dissatisfied</td> <td>0.00%</td> </tr> <tr> <td>quite dissatisfied</td> <td>25.00%</td> </tr> <tr> <td>neither satisfied or dissatisfied</td> <td>0.00%</td> </tr> <tr> <td>quite satisfied</td> <td>0.00%</td> </tr> <tr> <td>very satisfied</td> <td>50.00%</td> </tr> <tr> <td>do not know</td> <td>25.00%</td> </tr> </tbody> </table>	Satisfaction Level	Percentage	very dissatisfied	0.00%	quite dissatisfied	25.00%	neither satisfied or dissatisfied	0.00%	quite satisfied	0.00%	very satisfied	50.00%	do not know	25.00%		
Satisfaction Level	Percentage															
very dissatisfied	0.00%															
quite dissatisfied	25.00%															
neither satisfied or dissatisfied	0.00%															
quite satisfied	0.00%															
very satisfied	50.00%															
do not know	25.00%															

Figure 6.451 & Figure 6.452 Satisfaction of men and women with the access to parking spaces (during non-peak hours) Source: Own composition, based on the responses to question 22 of the Customer survey WP5, version Antwerp Airport

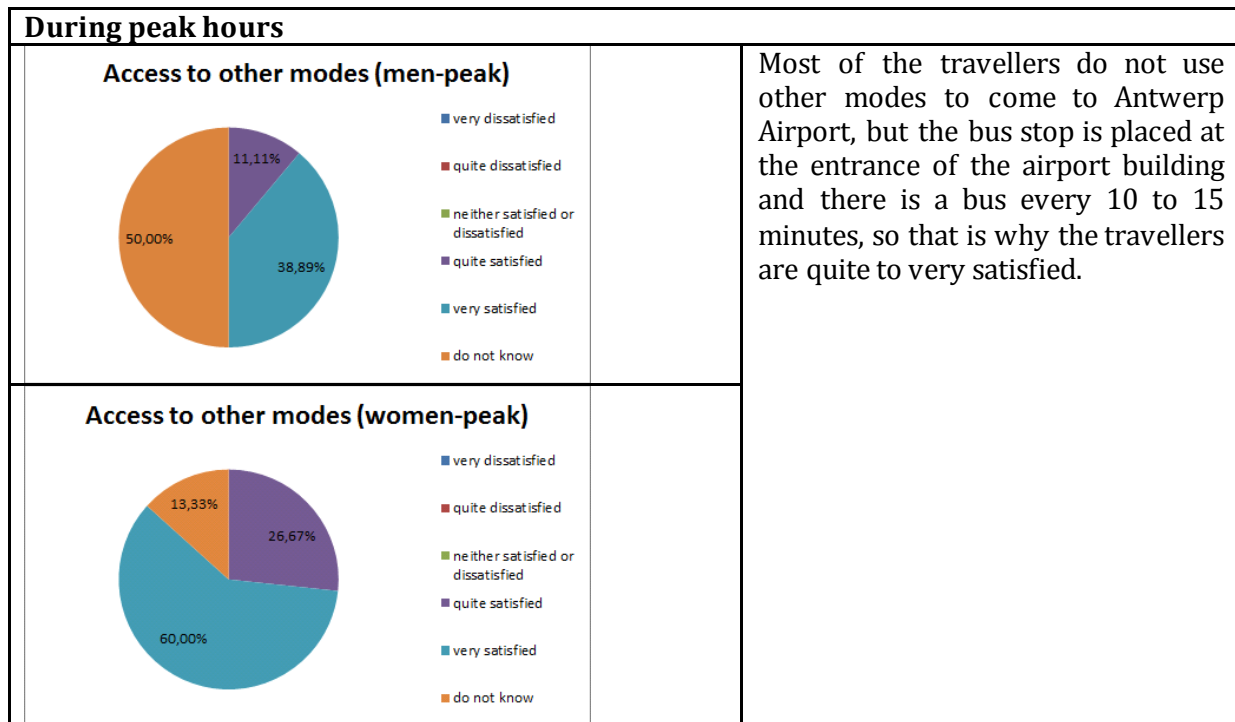


Figure 6.453 & Figure 6.454 Satisfaction of men and women with the access to other modes (during peak hours) Source: Own composition, based on the responses to question 22 of the Customer survey WP5, version Antwerp Airport

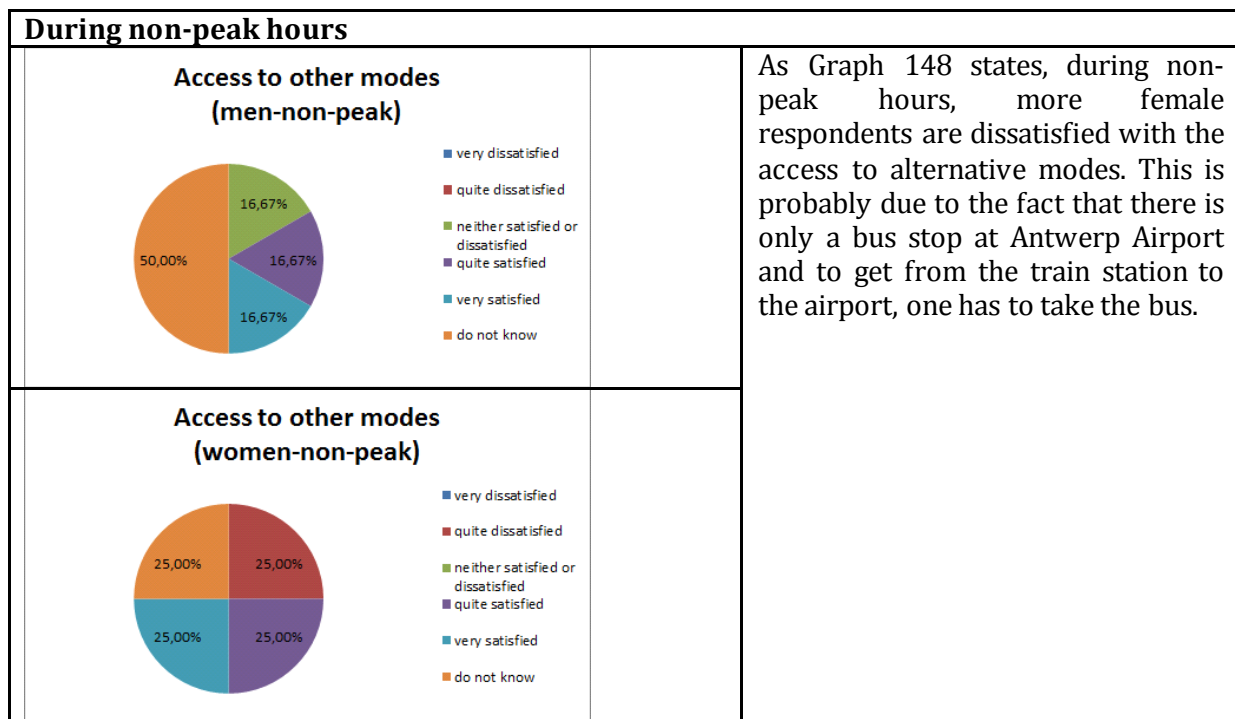


Figure 6.455 & Figure 6.456 Satisfaction of men and women with the access to other modes (during non-peak hours) Source: Own composition, based on the responses to question 22 of the Customer survey WP5, version Antwerp Airport

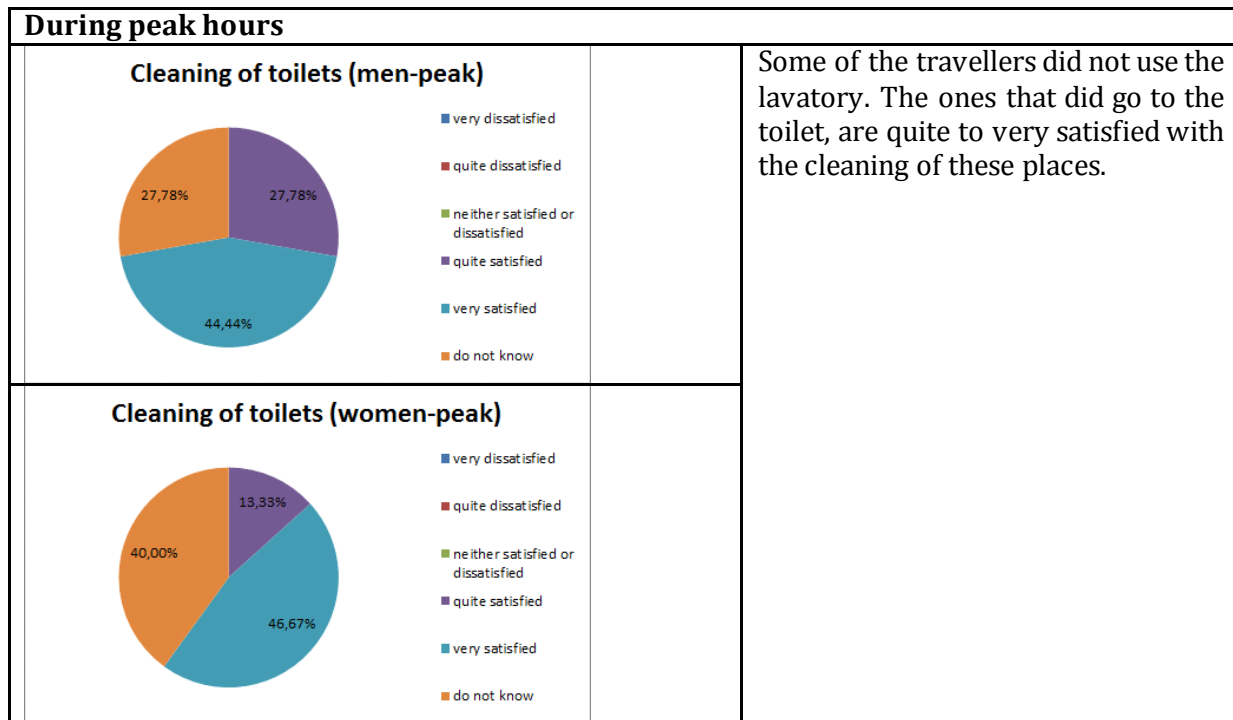


Figure 6.457 & Figure 6.458 Satisfaction of men and women with the cleaning of toilets (during peak hours)

Source: Own composition, based on the responses to question 22 of the Customer survey WP5, version Antwerp Airport

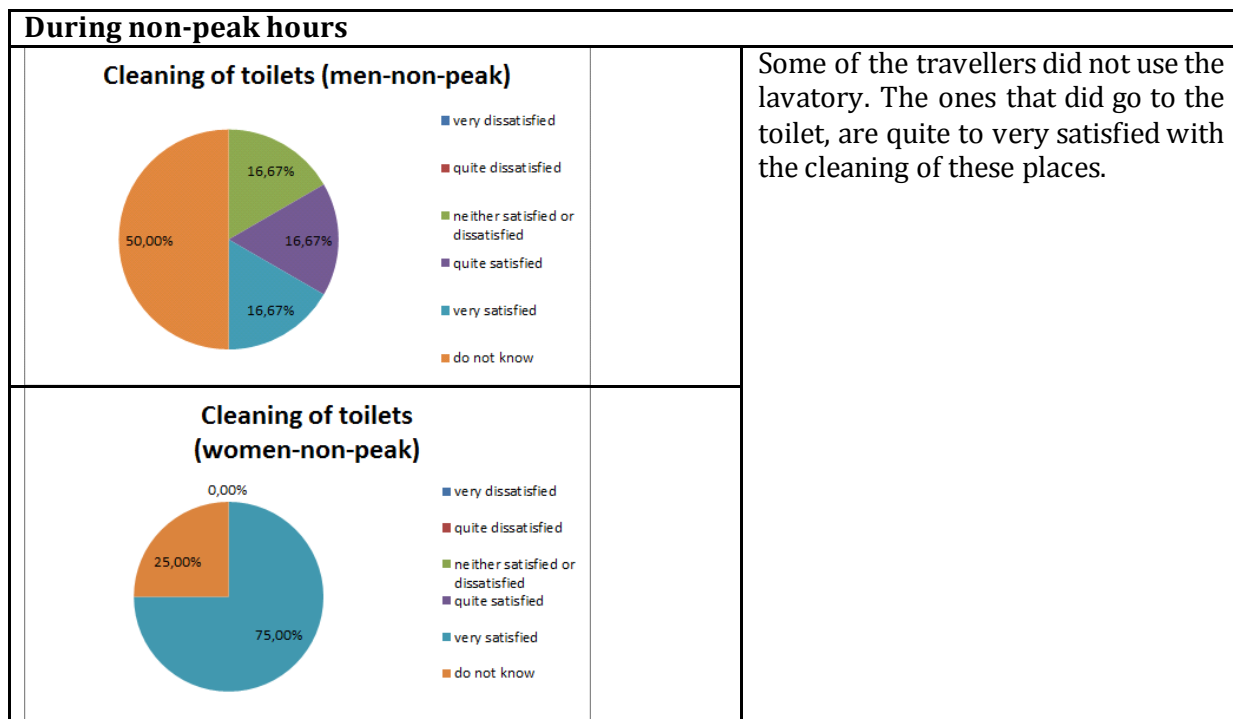


Figure 6.459 & Figure 6.460 Satisfaction of men and women with the cleaning of toilets (during non-peak hours) Source: Own composition, based on the responses to question 22 of the Customer survey WP5, version Antwerp Airport

During peak hours																
<p>Cleaning of total airport (men-peak)</p> <table border="1"> <caption>Satisfaction levels for men during peak hours</caption> <thead> <tr> <th>Satisfaction Level</th> <th>Percentage</th> </tr> </thead> <tbody> <tr> <td>very dissatisfied</td> <td>0,00%</td> </tr> <tr> <td>quite dissatisfied</td> <td>0,00%</td> </tr> <tr> <td>neither satisfied or dissatisfied</td> <td>0,00%</td> </tr> <tr> <td>quite satisfied</td> <td>33,33%</td> </tr> <tr> <td>very satisfied</td> <td>66,67%</td> </tr> <tr> <td>do not know</td> <td>0,00%</td> </tr> </tbody> </table>	Satisfaction Level	Percentage	very dissatisfied	0,00%	quite dissatisfied	0,00%	neither satisfied or dissatisfied	0,00%	quite satisfied	33,33%	very satisfied	66,67%	do not know	0,00%		<p>Error! Reference source not found. and Graph 154 show that all the travellers are quite to very satisfied with the cleaning of the airport.</p>
Satisfaction Level	Percentage															
very dissatisfied	0,00%															
quite dissatisfied	0,00%															
neither satisfied or dissatisfied	0,00%															
quite satisfied	33,33%															
very satisfied	66,67%															
do not know	0,00%															
<p>Cleaning of total airport (women-peak)</p> <table border="1"> <caption>Satisfaction levels for women during peak hours</caption> <thead> <tr> <th>Satisfaction Level</th> <th>Percentage</th> </tr> </thead> <tbody> <tr> <td>very dissatisfied</td> <td>0,00%</td> </tr> <tr> <td>quite dissatisfied</td> <td>0,00%</td> </tr> <tr> <td>neither satisfied or dissatisfied</td> <td>0,00%</td> </tr> <tr> <td>quite satisfied</td> <td>20,00%</td> </tr> <tr> <td>very satisfied</td> <td>80,00%</td> </tr> <tr> <td>do not know</td> <td>0,00%</td> </tr> </tbody> </table>	Satisfaction Level	Percentage	very dissatisfied	0,00%	quite dissatisfied	0,00%	neither satisfied or dissatisfied	0,00%	quite satisfied	20,00%	very satisfied	80,00%	do not know	0,00%		
Satisfaction Level	Percentage															
very dissatisfied	0,00%															
quite dissatisfied	0,00%															
neither satisfied or dissatisfied	0,00%															
quite satisfied	20,00%															
very satisfied	80,00%															
do not know	0,00%															

Figure 6.461 & Figure 6.462 Satisfaction of men and women with the cleaning of the total airport (during peak hours) Source: Own composition, based on the responses to question 22 of the Customer survey WP5, version Antwerp Airport

During non-peak hours																
<p>Cleaning of total airport (men-non-peak)</p> <table border="1"> <caption>Satisfaction levels for men during non-peak hours</caption> <thead> <tr> <th>Satisfaction Level</th> <th>Percentage</th> </tr> </thead> <tbody> <tr> <td>very dissatisfied</td> <td>0,00%</td> </tr> <tr> <td>quite dissatisfied</td> <td>0,00%</td> </tr> <tr> <td>neither satisfied or dissatisfied</td> <td>0,00%</td> </tr> <tr> <td>quite satisfied</td> <td>16,67%</td> </tr> <tr> <td>very satisfied</td> <td>83,33%</td> </tr> <tr> <td>do not know</td> <td>0,00%</td> </tr> </tbody> </table>	Satisfaction Level	Percentage	very dissatisfied	0,00%	quite dissatisfied	0,00%	neither satisfied or dissatisfied	0,00%	quite satisfied	16,67%	very satisfied	83,33%	do not know	0,00%		<p>Also during non-peak hours, travellers are satisfied with the cleanness of the airport.</p>
Satisfaction Level	Percentage															
very dissatisfied	0,00%															
quite dissatisfied	0,00%															
neither satisfied or dissatisfied	0,00%															
quite satisfied	16,67%															
very satisfied	83,33%															
do not know	0,00%															
<p>Cleaning of total airport (women-non-peak)</p> <table border="1"> <caption>Satisfaction levels for women during non-peak hours</caption> <thead> <tr> <th>Satisfaction Level</th> <th>Percentage</th> </tr> </thead> <tbody> <tr> <td>very dissatisfied</td> <td>0,00%</td> </tr> <tr> <td>quite dissatisfied</td> <td>0,00%</td> </tr> <tr> <td>neither satisfied or dissatisfied</td> <td>0,00%</td> </tr> <tr> <td>quite satisfied</td> <td>0,00%</td> </tr> <tr> <td>very satisfied</td> <td>100,00%</td> </tr> <tr> <td>do not know</td> <td>0,00%</td> </tr> </tbody> </table>	Satisfaction Level	Percentage	very dissatisfied	0,00%	quite dissatisfied	0,00%	neither satisfied or dissatisfied	0,00%	quite satisfied	0,00%	very satisfied	100,00%	do not know	0,00%		
Satisfaction Level	Percentage															
very dissatisfied	0,00%															
quite dissatisfied	0,00%															
neither satisfied or dissatisfied	0,00%															
quite satisfied	0,00%															
very satisfied	100,00%															
do not know	0,00%															

Figure 6.463 & Figure 6.464 Satisfaction of men and women with the cleaning of the total airport (during non-peak hours) Source: Own composition, based on the responses to question 22 of the Customer survey WP5, version Antwerp Airport

During peak hours																
<p>Ventilation of the airport (men-peak)</p> <table border="1"> <caption>Satisfaction levels for men during peak hours</caption> <thead> <tr> <th>Satisfaction Level</th> <th>Percentage</th> </tr> </thead> <tbody> <tr> <td>very dissatisfied</td> <td>0%</td> </tr> <tr> <td>quite dissatisfied</td> <td>0%</td> </tr> <tr> <td>neither satisfied or dissatisfied</td> <td>5,56%</td> </tr> <tr> <td>quite satisfied</td> <td>33,33%</td> </tr> <tr> <td>very satisfied</td> <td>61,11%</td> </tr> <tr> <td>do not know</td> <td>0%</td> </tr> </tbody> </table>	Satisfaction Level	Percentage	very dissatisfied	0%	quite dissatisfied	0%	neither satisfied or dissatisfied	5,56%	quite satisfied	33,33%	very satisfied	61,11%	do not know	0%		<p>Most of the passengers were quite to very satisfied with the ventilation of the airport.</p>
Satisfaction Level	Percentage															
very dissatisfied	0%															
quite dissatisfied	0%															
neither satisfied or dissatisfied	5,56%															
quite satisfied	33,33%															
very satisfied	61,11%															
do not know	0%															
<p>Ventilation of the airport (women-peak)</p> <table border="1"> <caption>Satisfaction levels for women during peak hours</caption> <thead> <tr> <th>Satisfaction Level</th> <th>Percentage</th> </tr> </thead> <tbody> <tr> <td>very dissatisfied</td> <td>0%</td> </tr> <tr> <td>quite dissatisfied</td> <td>0%</td> </tr> <tr> <td>neither satisfied or dissatisfied</td> <td>0%</td> </tr> <tr> <td>quite satisfied</td> <td>20,00%</td> </tr> <tr> <td>very satisfied</td> <td>66,67%</td> </tr> <tr> <td>do not know</td> <td>13,33%</td> </tr> </tbody> </table>	Satisfaction Level	Percentage	very dissatisfied	0%	quite dissatisfied	0%	neither satisfied or dissatisfied	0%	quite satisfied	20,00%	very satisfied	66,67%	do not know	13,33%		
Satisfaction Level	Percentage															
very dissatisfied	0%															
quite dissatisfied	0%															
neither satisfied or dissatisfied	0%															
quite satisfied	20,00%															
very satisfied	66,67%															
do not know	13,33%															

Figure 6.465 & Figure 6.466 Satisfaction of men and women with the ventilation at the airport/terminal (during peak hours) Source: Own composition, based on the responses to question 22 of the Customer survey WP5, version Antwerp Airport

During non-peak hours																
<p>Ventilation of the airport (men-non-peak)</p> <table border="1"> <caption>Satisfaction levels for men during non-peak hours</caption> <thead> <tr> <th>Satisfaction Level</th> <th>Percentage</th> </tr> </thead> <tbody> <tr> <td>very dissatisfied</td> <td>0%</td> </tr> <tr> <td>quite dissatisfied</td> <td>16,67%</td> </tr> <tr> <td>neither satisfied or dissatisfied</td> <td>0%</td> </tr> <tr> <td>quite satisfied</td> <td>66,67%</td> </tr> <tr> <td>very satisfied</td> <td>16,67%</td> </tr> <tr> <td>do not know</td> <td>0%</td> </tr> </tbody> </table>	Satisfaction Level	Percentage	very dissatisfied	0%	quite dissatisfied	16,67%	neither satisfied or dissatisfied	0%	quite satisfied	66,67%	very satisfied	16,67%	do not know	0%		<p>The travellers that were dissatisfied stated that during summer time or on warm days, it might get to hot in the airport building. The other passengers were quite to very satisfied</p>
Satisfaction Level	Percentage															
very dissatisfied	0%															
quite dissatisfied	16,67%															
neither satisfied or dissatisfied	0%															
quite satisfied	66,67%															
very satisfied	16,67%															
do not know	0%															
<p>Ventilation of the airport (women-non-peak)</p> <table border="1"> <caption>Satisfaction levels for women during non-peak hours</caption> <thead> <tr> <th>Satisfaction Level</th> <th>Percentage</th> </tr> </thead> <tbody> <tr> <td>very dissatisfied</td> <td>0%</td> </tr> <tr> <td>quite dissatisfied</td> <td>0%</td> </tr> <tr> <td>neither satisfied or dissatisfied</td> <td>0%</td> </tr> <tr> <td>quite satisfied</td> <td>0%</td> </tr> <tr> <td>very satisfied</td> <td>100,00%</td> </tr> <tr> <td>do not know</td> <td>0%</td> </tr> </tbody> </table>	Satisfaction Level	Percentage	very dissatisfied	0%	quite dissatisfied	0%	neither satisfied or dissatisfied	0%	quite satisfied	0%	very satisfied	100,00%	do not know	0%		
Satisfaction Level	Percentage															
very dissatisfied	0%															
quite dissatisfied	0%															
neither satisfied or dissatisfied	0%															
quite satisfied	0%															
very satisfied	100,00%															
do not know	0%															

Figure 6.467 & Figure 6.468 Satisfaction of men and women with the ventilation at the airport/terminal (during non-peak hours) Source: Own composition, based on the responses to question 22 of the Customer survey WP5, version Antwerp Airport

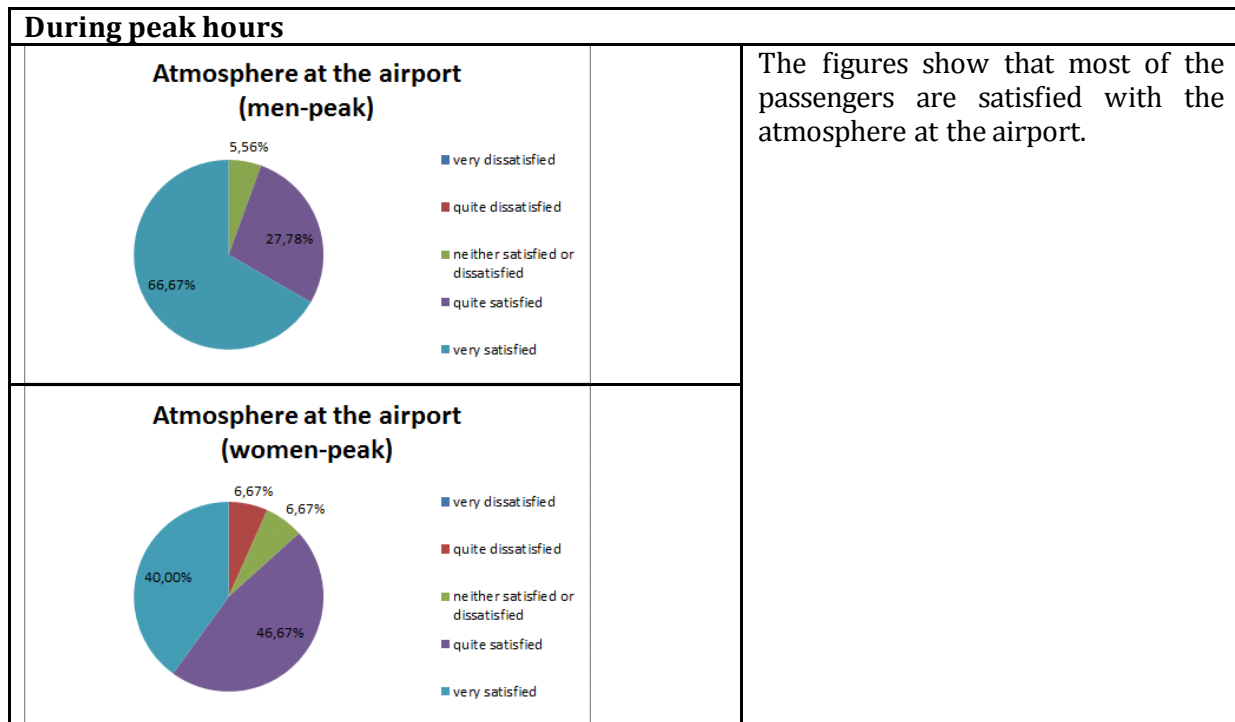


Figure 6.469 & Figure 6.470 Satisfaction of men and women with the atmosphere at the airport/terminal (during peak hours) Source: Own composition, based on the responses to question 22 of the Customer survey WP5, version Antwerp Airport

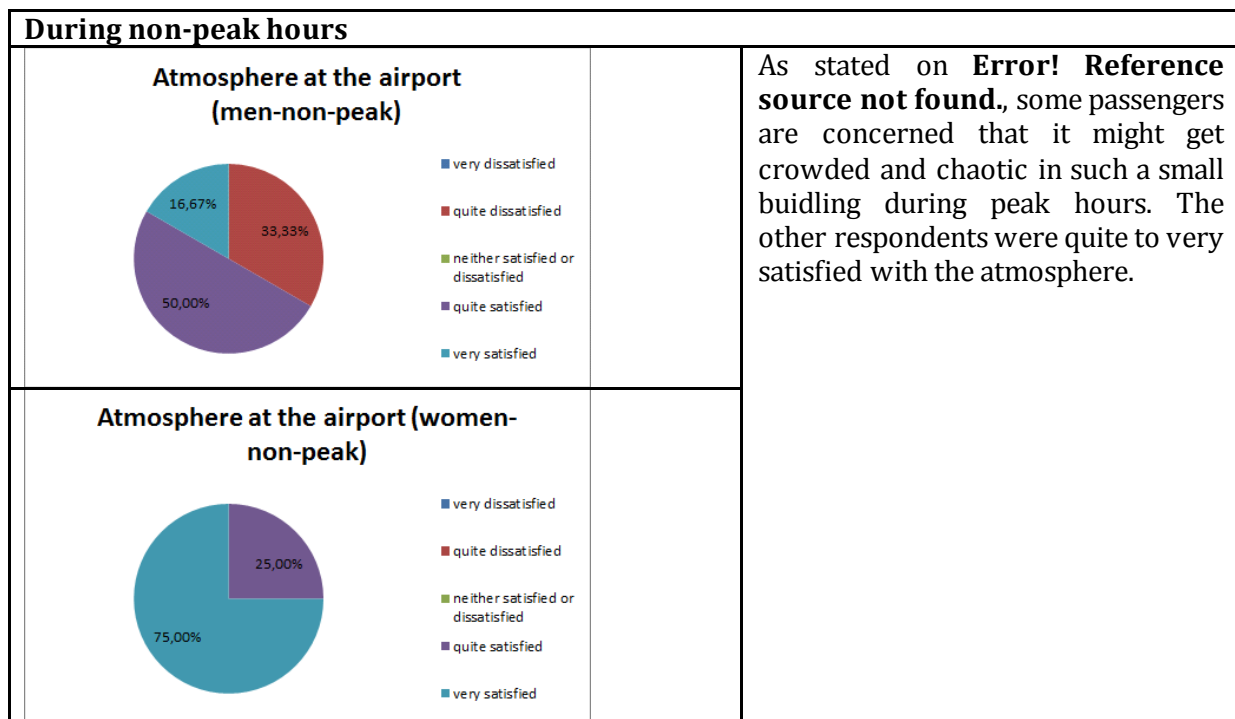


Figure 6.471 & Figure 6.472 Satisfaction of men and women with the atmosphere at the airport/terminal (during non-peak hours) Source: Own composition, based on the responses to question 22 of the Customer survey WP5, version Antwerp Airport

During peak hours														
<p>Safety/security at the airport (men-peak)</p> <table border="1"> <caption>Satisfaction levels for men during peak hours</caption> <thead> <tr> <th>Satisfaction Level</th> <th>Percentage</th> </tr> </thead> <tbody> <tr> <td>very satisfied</td> <td>66,67%</td> </tr> <tr> <td>quite satisfied</td> <td>33,33%</td> </tr> <tr> <td>neither satisfied or dissatisfied</td> <td>0%</td> </tr> <tr> <td>quite dissatisfied</td> <td>0%</td> </tr> <tr> <td>very dissatisfied</td> <td>0%</td> </tr> </tbody> </table>	Satisfaction Level	Percentage	very satisfied	66,67%	quite satisfied	33,33%	neither satisfied or dissatisfied	0%	quite dissatisfied	0%	very dissatisfied	0%		<p>Most of the travellers were quite to very satisfied with the safety and security on the site. However, the security controls are placed right after the entrance of the gate, which might cause crowded waiting lines during peak hours.</p>
Satisfaction Level	Percentage													
very satisfied	66,67%													
quite satisfied	33,33%													
neither satisfied or dissatisfied	0%													
quite dissatisfied	0%													
very dissatisfied	0%													
<p>Safety/security at the airport (women-peak)</p> <table border="1"> <caption>Satisfaction levels for women during peak hours</caption> <thead> <tr> <th>Satisfaction Level</th> <th>Percentage</th> </tr> </thead> <tbody> <tr> <td>very satisfied</td> <td>80,00%</td> </tr> <tr> <td>quite satisfied</td> <td>13,33%</td> </tr> <tr> <td>quite dissatisfied</td> <td>6,67%</td> </tr> <tr> <td>neither satisfied or dissatisfied</td> <td>0%</td> </tr> <tr> <td>very dissatisfied</td> <td>0%</td> </tr> </tbody> </table>	Satisfaction Level	Percentage	very satisfied	80,00%	quite satisfied	13,33%	quite dissatisfied	6,67%	neither satisfied or dissatisfied	0%	very dissatisfied	0%		
Satisfaction Level	Percentage													
very satisfied	80,00%													
quite satisfied	13,33%													
quite dissatisfied	6,67%													
neither satisfied or dissatisfied	0%													
very dissatisfied	0%													

Figure 6.473 & Figure 6.474 Satisfaction of men and women with the safety/security at the airport/terminal (during peak hours) Source: Own composition, based on the responses to question 22 of the Customer survey WP5, version Antwerp Airport

During non-peak hours														
<p>Safety/security at the airport (men-non-peak)</p> <table border="1"> <caption>Satisfaction levels for men during non-peak hours</caption> <thead> <tr> <th>Satisfaction Level</th> <th>Percentage</th> </tr> </thead> <tbody> <tr> <td>very satisfied</td> <td>33,33%</td> </tr> <tr> <td>quite satisfied</td> <td>50,00%</td> </tr> <tr> <td>quite dissatisfied</td> <td>16,67%</td> </tr> <tr> <td>neither satisfied or dissatisfied</td> <td>0%</td> </tr> <tr> <td>very dissatisfied</td> <td>0%</td> </tr> </tbody> </table>	Satisfaction Level	Percentage	very satisfied	33,33%	quite satisfied	50,00%	quite dissatisfied	16,67%	neither satisfied or dissatisfied	0%	very dissatisfied	0%		<p>Most of the travellers were quite to very satisfied with the safety and security on the site. However, the security controls are placed right after the entrance of the gate, which might cause crowded waiting lines during peak hours.</p>
Satisfaction Level	Percentage													
very satisfied	33,33%													
quite satisfied	50,00%													
quite dissatisfied	16,67%													
neither satisfied or dissatisfied	0%													
very dissatisfied	0%													
<p>Safety/security at the airport (women-non-peak)</p> <table border="1"> <caption>Satisfaction levels for women during non-peak hours</caption> <thead> <tr> <th>Satisfaction Level</th> <th>Percentage</th> </tr> </thead> <tbody> <tr> <td>very satisfied</td> <td>75,00%</td> </tr> <tr> <td>neither satisfied or dissatisfied</td> <td>25,00%</td> </tr> <tr> <td>quite satisfied</td> <td>0%</td> </tr> <tr> <td>quite dissatisfied</td> <td>0%</td> </tr> <tr> <td>very dissatisfied</td> <td>0%</td> </tr> </tbody> </table>	Satisfaction Level	Percentage	very satisfied	75,00%	neither satisfied or dissatisfied	25,00%	quite satisfied	0%	quite dissatisfied	0%	very dissatisfied	0%		
Satisfaction Level	Percentage													
very satisfied	75,00%													
neither satisfied or dissatisfied	25,00%													
quite satisfied	0%													
quite dissatisfied	0%													
very dissatisfied	0%													

Figure 6.475 & Figure 6.476 Satisfaction of men and women with the safety/security at the airport/terminal (during non-peak hours) Source: Own composition, based on the responses to question 22 of the Customer survey WP5, version Antwerp Airport

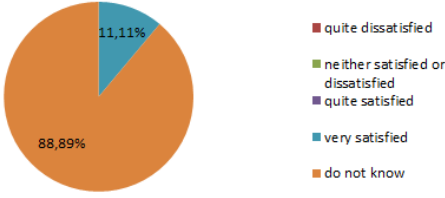
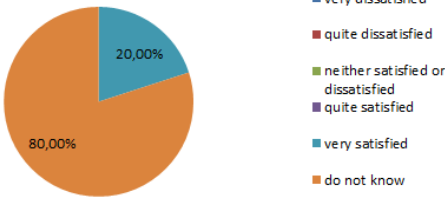
During peak hours														
<p>Facilities/support for people with disabilities (men-peak)</p>  <table border="1"> <tr><td>very dissatisfied</td><td>0%</td></tr> <tr><td>quite dissatisfied</td><td>0%</td></tr> <tr><td>neither satisfied or dissatisfied</td><td>0%</td></tr> <tr><td>quite satisfied</td><td>0%</td></tr> <tr><td>very satisfied</td><td>11,11%</td></tr> <tr><td>do not know</td><td>88,89%</td></tr> </table>	very dissatisfied	0%	quite dissatisfied	0%	neither satisfied or dissatisfied	0%	quite satisfied	0%	very satisfied	11,11%	do not know	88,89%		<p>As can be seen in the figures, most of the respondents has no experience with the facilities or support for people with disabilities. The few travellers who have experienced these services, are very satisfied about them.</p>
very dissatisfied	0%													
quite dissatisfied	0%													
neither satisfied or dissatisfied	0%													
quite satisfied	0%													
very satisfied	11,11%													
do not know	88,89%													
<p>Facilities/support for people with disabilities (women-peak)</p>  <table border="1"> <tr><td>very dissatisfied</td><td>0%</td></tr> <tr><td>quite dissatisfied</td><td>0%</td></tr> <tr><td>neither satisfied or dissatisfied</td><td>0%</td></tr> <tr><td>quite satisfied</td><td>0%</td></tr> <tr><td>very satisfied</td><td>20,00%</td></tr> <tr><td>do not know</td><td>80,00%</td></tr> </table>	very dissatisfied	0%	quite dissatisfied	0%	neither satisfied or dissatisfied	0%	quite satisfied	0%	very satisfied	20,00%	do not know	80,00%		
very dissatisfied	0%													
quite dissatisfied	0%													
neither satisfied or dissatisfied	0%													
quite satisfied	0%													
very satisfied	20,00%													
do not know	80,00%													

Figure 6.477 & Figure 6.478 Satisfaction of men and women with the facilities/support for people with disabilities (during peak hours) Source: Own composition, based on the responses to question 22 of the Customer survey WP5, version Antwerp Airport

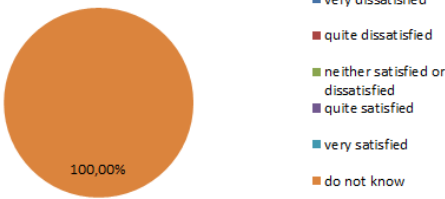
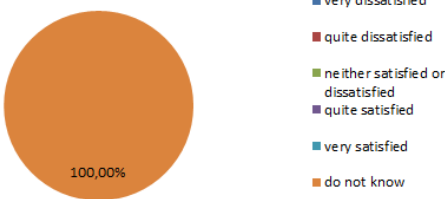
During non-peak hours														
<p>Facilities/support for people with disabilities (men-non-peak)</p>  <table border="1"> <tr><td>very dissatisfied</td><td>0%</td></tr> <tr><td>quite dissatisfied</td><td>0%</td></tr> <tr><td>neither satisfied or dissatisfied</td><td>0%</td></tr> <tr><td>quite satisfied</td><td>0%</td></tr> <tr><td>very satisfied</td><td>0%</td></tr> <tr><td>do not know</td><td>100,00%</td></tr> </table>	very dissatisfied	0%	quite dissatisfied	0%	neither satisfied or dissatisfied	0%	quite satisfied	0%	very satisfied	0%	do not know	100,00%		<p>As can be seen in the figures most of the respondents have no experience with the facilities or support for people with disabilities. The few travellers who have experienced these services, are very satisfied about them.</p>
very dissatisfied	0%													
quite dissatisfied	0%													
neither satisfied or dissatisfied	0%													
quite satisfied	0%													
very satisfied	0%													
do not know	100,00%													
<p>Facilities/support for people with disabilities (women-non-peak)</p>  <table border="1"> <tr><td>very dissatisfied</td><td>0%</td></tr> <tr><td>quite dissatisfied</td><td>0%</td></tr> <tr><td>neither satisfied or dissatisfied</td><td>0%</td></tr> <tr><td>quite satisfied</td><td>0%</td></tr> <tr><td>very satisfied</td><td>0%</td></tr> <tr><td>do not know</td><td>100,00%</td></tr> </table>	very dissatisfied	0%	quite dissatisfied	0%	neither satisfied or dissatisfied	0%	quite satisfied	0%	very satisfied	0%	do not know	100,00%		
very dissatisfied	0%													
quite dissatisfied	0%													
neither satisfied or dissatisfied	0%													
quite satisfied	0%													
very satisfied	0%													
do not know	100,00%													

Figure 6.479 & Figure 6.480 Satisfaction of men and women with the facilities/support for people with disabilities (during non-peak hours) Source: Own composition, based on the responses to question 22 of the Customer survey WP5, version Antwerp Airport

During peak hours														
<p>Possibilities to travel with pets (men-peak)</p> <table border="1"> <tr><td>very dissatisfied</td><td>0%</td></tr> <tr><td>quite dissatisfied</td><td>0%</td></tr> <tr><td>neither satisfied or dissatisfied</td><td>0%</td></tr> <tr><td>quite satisfied</td><td>0%</td></tr> <tr><td>very satisfied</td><td>0%</td></tr> <tr><td>do not know</td><td>100,00%</td></tr> </table>	very dissatisfied	0%	quite dissatisfied	0%	neither satisfied or dissatisfied	0%	quite satisfied	0%	very satisfied	0%	do not know	100,00%		<p>The figures show that, during peak hours, few travellers have experience with travelling with pets. The women that have travelled with their pets is either very satisfied or very dissatisfied with it. Given the fact that travelling with pets is not possible at Antwerp Airport, the one female respondent who is happy, probably does not want animals on board.</p>
very dissatisfied	0%													
quite dissatisfied	0%													
neither satisfied or dissatisfied	0%													
quite satisfied	0%													
very satisfied	0%													
do not know	100,00%													
<p>Possibilities to travel with pets (women-peak)</p> <table border="1"> <tr><td>very dissatisfied</td><td>13,33%</td></tr> <tr><td>quite dissatisfied</td><td>0%</td></tr> <tr><td>neither satisfied or dissatisfied</td><td>0%</td></tr> <tr><td>quite satisfied</td><td>0%</td></tr> <tr><td>very satisfied</td><td>6,67%</td></tr> <tr><td>do not know</td><td>80,00%</td></tr> </table>	very dissatisfied	13,33%	quite dissatisfied	0%	neither satisfied or dissatisfied	0%	quite satisfied	0%	very satisfied	6,67%	do not know	80,00%		
very dissatisfied	13,33%													
quite dissatisfied	0%													
neither satisfied or dissatisfied	0%													
quite satisfied	0%													
very satisfied	6,67%													
do not know	80,00%													

Figure 6.481 & Figure 6.482 Satisfaction of men and women with the possibility to travel with pets (during peak hours) Source: Own composition, based on the responses to question 22 of the Customer survey WP5, version Antwerp Airport

During non-peak hours														
<p>Possibilities to travel with pets (men-non-peak)</p> <table border="1"> <tr><td>very dissatisfied</td><td>0%</td></tr> <tr><td>quite dissatisfied</td><td>16,67%</td></tr> <tr><td>neither satisfied or dissatisfied</td><td>0%</td></tr> <tr><td>quite satisfied</td><td>0%</td></tr> <tr><td>very satisfied</td><td>0%</td></tr> <tr><td>do not know</td><td>83,33%</td></tr> </table>	very dissatisfied	0%	quite dissatisfied	16,67%	neither satisfied or dissatisfied	0%	quite satisfied	0%	very satisfied	0%	do not know	83,33%		<p>As stated in the figures, most of the passengers have no experience with travelling with pets. Since it is not allowed, some male respondents are quite dissatisfied.</p>
very dissatisfied	0%													
quite dissatisfied	16,67%													
neither satisfied or dissatisfied	0%													
quite satisfied	0%													
very satisfied	0%													
do not know	83,33%													
<p>Possibilities to travel with pets (women-non-peak)</p> <table border="1"> <tr><td>very dissatisfied</td><td>0%</td></tr> <tr><td>quite dissatisfied</td><td>0%</td></tr> <tr><td>neither satisfied or dissatisfied</td><td>0%</td></tr> <tr><td>quite satisfied</td><td>0%</td></tr> <tr><td>very satisfied</td><td>0%</td></tr> <tr><td>do not know</td><td>100,00%</td></tr> </table>	very dissatisfied	0%	quite dissatisfied	0%	neither satisfied or dissatisfied	0%	quite satisfied	0%	very satisfied	0%	do not know	100,00%		
very dissatisfied	0%													
quite dissatisfied	0%													
neither satisfied or dissatisfied	0%													
quite satisfied	0%													
very satisfied	0%													
do not know	100,00%													

Figure 6.483 & Figure 6.484 Satisfaction of men and women with the possibility to travel with pets (during non-peak hours) Source: Own composition, based on the responses to question 22 of the Customer survey WP5, version Antwerp Airport

Taking into account the figures concerning the facilities, it becomes clear that some facilities are rather poor. For starters, some people are dissatisfied with the airport shop. This however depends on what the traveller expects to find there. Furthermore, most of the travellers never used the banking services at Antwerp Airport, but some stress the fact that there is no possibility to withdraw cash. They would like to see a cash withdrawal machine appear in the airport building. Thanks to the short waiting time, not all travellers are in need of internet access. This is available, but is not free. That is why quite a lot of travellers stress that free wifi would be welcome. Fourthly, work facilities are absent and lounges are underused, but most travellers do not seem to mind about that. Travelling with pets is not possible at Antwerp Airport, but few travellers have experience with that. More and better access to other modes, especially train, might be useful. Having a train station at the site (which in theory is possible, since Antwerp Airport is next to a railway), might raise the use of public transport as an access mode.

Still, there are some facilities which are quite good. As concerns the access to lavatories, the travellers that have used them, are satisfied. They also state that the toilets are clean, as is the total airport building. Also the ventilation and the atmosphere in the airport building are perceived as good by most of the respondents. The parking spaces are free and right in front of the airport building, which is a good thing, but some travellers stress the fact that they would gladly pay for a guarded parking lot. Apart from that, the safety and security at the site are satisfactory.

Furthermore, to improve the service for the passengers, a snackbar or coffee shop is wanted. Especially at the gate, some fresh food and drinks are needed. Other shops are also welcome at the gate, for instance a bookshop. If this is not possible, an information sign indicating that there are no shops after security, is needed. Passengers also requested more power outlets and a clock at the gate.

As stated before, the airport can be better accessible by installing a train station, or a tramline which goes from the city centre up to the airport. Better access roads are also welcome.

6.7.8 Analysis for improvement of interconnectivity

In this chapter, the current Value Proposition, the current Business Model, the results from observations, customer survey and stakeholder interviews are compared and analysed.

6.7.8.1 *Comparison between customers and stakeholders*

In this section, a summarized description of interconnectivity at Antwerp Airport is given. To make this analysis, the stakeholder and customer satisfaction is compared.

First, it needs to be stressed again that at Antwerp Airport, intermodality is rather limited. The airport is directly accessible via road: by car, taxi or bus. Given the fact that the bus stop is at the entrance of the airport building and that the bus stops there every 15 minutes, real co-ordination and co-operation (between the airport management and the bus company) is not necessary.

All three modes are low capacity modes, travelling relatively short distances. Also the air connection available at Antwerp Airport has a low capacity (about 50 travellers per plane) and travels short distances (<700km).

6.7.8.1.1 Travel demand/Passenger flow

Stakeholders at Antwerp Airport are satisfied with the number of travellers passing through the airport. The number has been fluctuating over the years and fluctuates within a year, but given the size of the airport, this number is sufficient.

The customers of the airport have a specific profile: they are commuting business travellers and thus in need of flights that depart early on a working day. Antwerp Airport and CityJet try to deliver this service and the customers are satisfied with what they are offered. Since they access the airport mainly through car and taxi, more elaborated intermodal transport is not necessary.

The stakeholders interviewed stressed the fact that a better train connection would be welcome since this might attract more leisure travellers. However, they also stated that the present customers of the airport are in no need of a better interconnectivity by public transport: business travellers access the airport by car or taxi. This also became clear from the surveys: the majority of the travellers questioned arrived at the airport by car or taxi and were satisfied with the accessibility of the airport.

6.7.8.1.2 Time

For business travellers, the total travel time is crucial. The total travel time consists of three components, i.e. the in-vehicle time, the walking time and the waiting time (Blauwens et al, 2008, p. 271). At Antwerp Airport, efforts are made to reduce these different times. In-vehicle

time is reduced to the minimum thanks to punctuality. The survey results confirm that passengers are satisfied with the punctuality of the flights at Antwerp Airport. Secondly, thanks to the short walking distances between the parking spaces and within the airport building, the walking time is not too long. Antwerp Airport has a 20 min.' check-in concept which makes that the passengers can check in until 20 minutes before departure, which reduces the waiting time. Given the limited amount of passengers per flight (about 50), the waiting time at the security check is not too long.

Looking at these three components, one can see that the service time, waiting time and transboarding time are much lower in Antwerp Airport than in any other (Belgian) airport. Antwerp Airport really makes efforts to save time so that their main audience, the business traveller who finds time a crucial factor, is satisfied. This is confirmed when looking at the survey results: respondents were satisfied with the check-in time and the service at the check-in counter. Although the majority of the respondents had no experience with dropping off baggage, most of the passengers were satisfied with the time needed for baggage drop off. Time spent at the security control and the time needed for transfer were satisfying.

6.7.8.1.3 Space

At Antwerp Airport, all the available modes are located at one level: the parking spaces, the bus stop and the gates are all on the ground floor. The airport building itself is rather small which makes it easy to move around and makes other facilities such as luggage storage or luggage trolleys unnecessary. The survey showed that indeed passengers found it rather easy to find their way at the site. Most of the travellers did not use luggage storage or trolleys but those that did use these facilities, were satisfied with it. Respondents indicated that there were not enough seats in the airport building, but at the gate, this was not a problem. The airport management felt that, thanks to the short check-in and waiting time, seats in other parts of the airport building were not needed.

6.7.8.1.4 Information, Ticketing and Check-in Services

The absence of intermodality or of coordination of modes makes that the information, ticketing and check-in services at Antwerp Airport are limited to the services related to air transport. Pre-trip information is distributed through various channels: internet, magazines, brochures, ... The customers of Antwerp Airport are frequent visitors and are familiar with the site. Therefore, superfluous on-trip information is not necessary. Thanks to the size of the airport, information signs are not needed and therefore not noticed by the passengers. Nowadays, most tickets are bought online and also online check-in is often used. This reduces the need of those desks, but the travellers who did turn to the check-in or ticket counters, were satisfied with the service delivered.

6.7.8.1.5 Added value at the site

Concerning intermodality and interconnectivity, especially the parking spaces available are important. There are 500 free parking spaces right next to the airport building, so most of the travellers are satisfied with this.

Other facilities that might add value to the airport experience are the airport shop and the banking services. There is a small airport shop and a bank agency present in the airport building, but these offer limited services. Larger shops or cash withdrawal are absent due to the large costs these services imply: there are not enough passengers to make the provision of these services profitable.

Services such as toilets, cleaning of the airport and the ventilation are satisfying. The stakeholders stressed that the relatively small size of the airport adds to the atmosphere at the airport and the survey results confirm that passengers are satisfied.

6.7.8.2 *Validation of findings in WP3/WP4*

The largest interconnectivity barrier at Antwerp Airport, is that the airport is poorly accessible, contrary to what the airport management claims. Antwerp Airport is directly accessible via road: by car, taxi or bus. However, during peak hours, there are a lot of traffic jams on Belgian roads, especially in large cities such as Antwerp. Furthermore, contrary to what can be found on the website of Antwerp Airport, the site is not accessible (or at least not directly accessible) by train: a traveller arriving at Antwerp Central Station or the station of Antwerp Berchem has to take the bus to reach Antwerp Airport.

6.7.8.3 *Missing links and new Value Proposition*

The value proposition of Antwerp Airport is completely designed for its target customer, the business traveller, and is built upon three pillars: small airport with a large, free parking and a

20 min.' check-in concept. These three assets are put together to make sure the passenger does not have to waste any of his valuable time.

Services directly related to the travelling by air such as check-in, waiting time/punctuality, etc. are satisfying to the customer of the airport. Facilities that add some value to the airport experience such as retail could be improved.

As already stated before, Antwerp Airport is in need of better accessibility, preferably intermodal transport. The bus services that are present at the airport building now, are completely independent from the services delivered at the airport. Furthermore, there is no direct rail connection (train or tram). Having a train station or tram terminal at the airport would probably attract more, and even leisure, passengers.

Here, a footnote has to be made: attracting more leisure passengers would imply that the value proposition of the current business model has to be altered. For starters, leisure travellers find the facilities at the site (e.g. retail, restaurants, ...) much more important. Also larger waiting areas and more security checkpoints have to be installed. To attract the leisure traveller and make sure that he keeps coming to Antwerp Airport, it is probably necessary to offer more destinations.

6.7.9 Actions for improvement of interconnectivity

In this chapter, the proposal for a new business model is described. The first section studies the current barriers and how this proposal can overcome these barriers. Then, the changes to the nine building blocks of the Osterwalder model are described and the changes to the (interaction between the) agents is analyzed. The validation of this new proposal and the added value of this case study for the entire project is studied.

6.7.9.1 Proposal

6.7.9.1.1 Barriers/problems (for intermodality)

Currently, only a limited number of transport operators available to bring the passenger from the airport to his final destination. Passengers are not very satisfied with the public transport services such as bus and taxi. For example, the passengers have to wait about 10 minutes before a bus arrives and that is if the bus arrives. Busses serving Antwerp Airport have to make a slight detour to stop at the bus stop at the entrance of the airport building. If the bus is behind schedule, the driver dares to skip the detour to save time.



Figure 6.485: Route of bus serving Antwerp Airport
Source: Own composition, based on existing map (Google Maps)

Another disadvantage the bus has, is that it cannot bring the passenger to his / her final destination. The bus only stops at a bus stop near the final destination of the traveller.

Business travellers tend to choose the taxi since the traveller can be dropped off at the right location. A taxi ride is more expensive than taking the bus, but business travellers are more time-sensitive than cost-sensitive. The downside of taking a taxi is that some passengers and the airport management reported rather rude behaviour of the taxi drivers at Antwerp Airport and business travellers want comfort while travelling and expect a good service.

The third option available at Antwerp Airport, interesting for both leisure and business travellers, is renting a car. However, the traveller cannot decide on the spot to do so; he has to book a car in advance.

The other transport mode the passenger can take is the train. However, this mode is not directly available at the site; the traveller has to take the bus to get to the nearest train station (station of Antwerp Berchem).

These disadvantages lead most passengers (business and leisure), passing through Antwerp Airport, to use their own car to get to their final destination. Antwerp Airport is well accessible by car since there is a large parking lot in front of the airport building. However, as on most roads in Belgium, there are traffic jams on the roads leading to the airport.

6.7.9.1.2 Possible solutions

To overcome these barriers, the airport management has to try and co-operate with the different transport providers to make the airport better accessible. Doing so, they have to bear in mind that the different customer segments have different needs.

6.7.9.1.3 Short term

In the short term, the management can try to find an agreement with the taxi companies. Such an agreement can contain requirements about the service delivered by the taxi drivers and in return, the management can promote the use of taxi's among their (business) travellers, for example by giving information during the flight.

To offer a better accessibility to the leisure travellers, the airport management can co-operate with the bus company. An agreement that the travellers can use their boarding pass to take the bus (for free) would stimulate the use of the bus. Furthermore, information about the bus time schedule etc. needs to be distributed on the flight and at the airport. Obviously, punctuality (of the bus company) is required to attract as many customers as possible.

A similar agreement can also be established with the car rental company. For example, when the traveller shows the boarding pass, he gets a discount when he rents a car. In return, the car rental company can advertise at the airport and on the airport website.

These measures would make the airport better accessible, would stimulate the use of public transport (and therefore lower the congestion around the airport) and would deal with the negative image of bus and taxi companies (due to their bad service).

6.7.9.1.4 Long term

At longer term, the airport can try to come to an agreement with the rail services provider. Since the rail runs right next to the airport site, a train stop could be installed at Antwerp Airport. This would make Antwerp Airport better accessible when coming from other large cities (such as Brussels).

Ticket integration and service level agreements would be necessary, but these are the only investments needed. Since only passengers passing through Antwerp Airport would use this train stop, constructing a train station building is not necessary since (if tickets are integrated) no ticket purchase is needed. Alternatively, it is also possible to buy a ticket on the train.

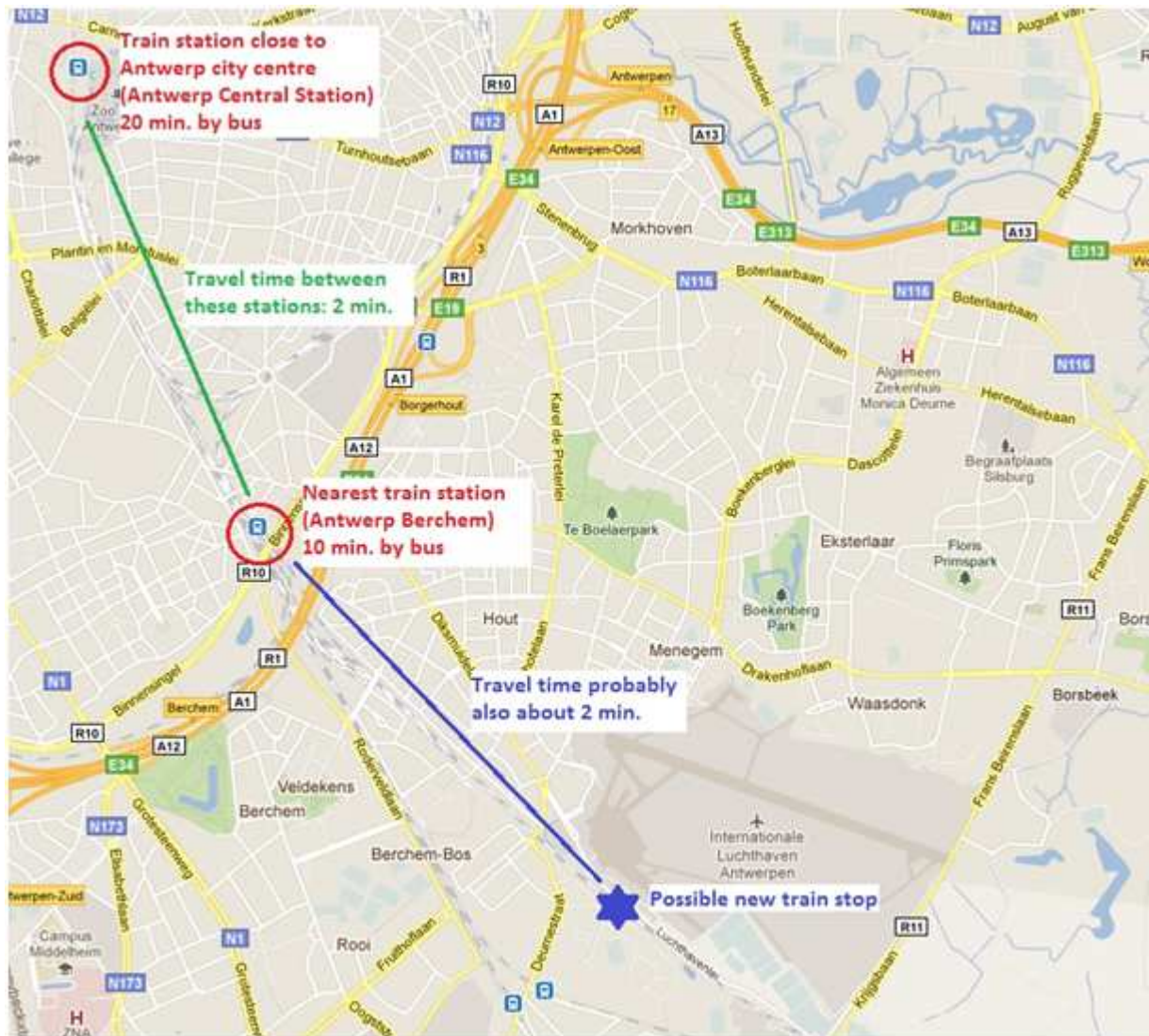


Figure 6.486: Map with possible new train station at Antwerp Airport
Source: Own composition, based on existing map (Google Maps)

Installing a train stop at the airport, would make the airport directly accessible by train. This would attract more customers for the airport and would provide the rail operator with new customers: customers who would have used their car to travel from another large city to the airport can now take the train.

6.7.9.2 Description of new business model

If Antwerp Airports improves its accessibility, more leisure travellers will probably be attracted. This alters the customers profile of the airport and thus, the airport management will have to adapt its value proposition. Figure 6.487 shows the current business model, built around the current targeted customer.

Key partners <ul style="list-style-type: none"> The airport is part of the Flemish Government Concessions from the businesses on the site 	Key Activities Providing short distance air transport services	Value Proposition <ul style="list-style-type: none"> 2 destinations: London (City) & Manchester The services are adapted to the demand of the main customers: <ul style="list-style-type: none"> Quick (20 minutes concept, large parking close by, small building with short walking distances) Not much additional services (such as retail needed) 	Customer Relationships <ul style="list-style-type: none"> Personal service (thanks to the relatively small airport) Fidelity programs (thanks to the merger with KLM/Air France) 	Customer Segments Business traveller, majority is male and between 36 and 55
	Key Resources <ul style="list-style-type: none"> Personnel Infrastructure Fleet of small airplanes No slots 		Channels <ul style="list-style-type: none"> Pre-trip information <ul style="list-style-type: none"> Website, brochures, ... On-trip information <ul style="list-style-type: none"> Not needed thanks to frequent visits Ticket sales <ul style="list-style-type: none"> Internet, travel agencies, ticket desks 	
Cost Structure <ul style="list-style-type: none"> Exploitation and investments (partly paid by money from endowments): maintenance of airport building, salaries, ... Safety and security costs are the main costs 		Revenue streams <ul style="list-style-type: none"> Airport has some endowment from the Flemish Government Concessions from the businesses on the site Ticket sale 		

Figure 6.487: Current Business Model of Antwerp Airport

Source: Own composition, based on Osterwalder

Making Antwerp Airport more accessible implies (more) cooperation with other transport providers, such as co-ordination of timetables with the bus company, construction of a train station or tram terminal etc.

The direct result²⁰ of this improved accessibility, is the change in the customer profile: next to business travellers, also leisure travellers are attracted.

This implies also other changes²¹ to the business model to satisfy this new group of customers. First of all, the value proposition has to be altered. The airport would have to offer more destinations and additional services (such as retail). Furthermore, a larger check-in area and more ticket desks would have to be installed. Offering more (and thus other) destinations has some consequences for the key activities and key resources: it might imply that other airlines get attracted, that they provide also long distance flights, that the planes have to be bigger, etc.

All these changes also imply an altered cost structure and other revenue streams²². If more retail services (shops, restaurants, etc.) are offered, the airport has some commercial revenue or gets more income from rents (if the retail is exploited independently). Moreover, the costs for maintenance, personnel etc. will rise.

²⁰ Indicated in red on Figure 6.488

²¹ Indicated in green on Figure 6.488

²² Indicated in blue on Figure 6.488

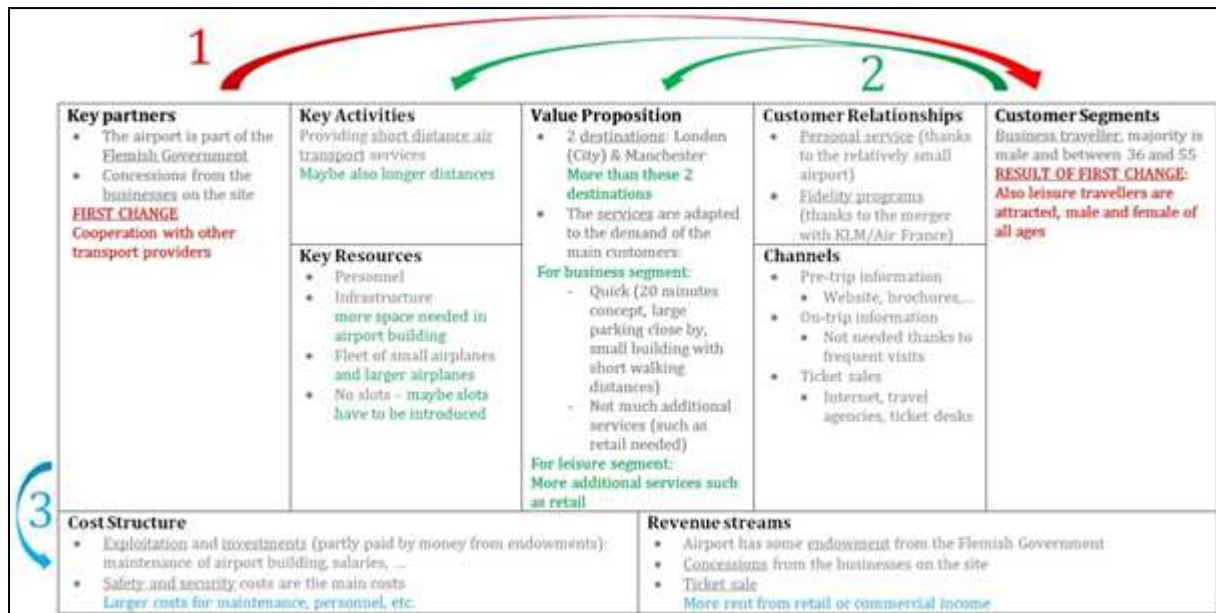


Figure 6.488: Altered business model, as a result of better accessibility

Source: Own composition, based on Osterwalder

6.7.9.2.1 Customer Segments (CS)

The customers segments applied in the current business model would stay the same, but a different service would be offered to each segment. For the business travellers, the taxi service would be improved while more leisure travellers would be attracted because they are offered a better service by the bus company. Both segments would get a discount at the car rental company and would have direct rail access to the airport.

6.7.9.2.2 Value Proposition (VP)

By making agreements with the (public) transport providers, the different transport legs would be integrated more. This would make the airport better accessible and would lower the congestion on the roads surrounding the airport. Besides these transport-related changes, more destinations and other additional services are recommended to attract more leisure travellers.

6.7.9.2.3 Channels (CH)

Information regarding coordination of timetables, tariffs, etc. would be distributed online (pre-trip info) and on the flight (on-trip info).

6.7.9.2.4 Customer Relationships (CR)

Since the customers are offered a better accessibility, they are offered a better all-round service.

6.7.9.2.5 Revenue Streams (R\$)

Stimulating the use of the different transport services would result in a larger ticket sale and thus more revenues. The extra tickets sold, would be sold at a lower price, but in return, the

airport provides marketing for the companies. Furthermore, providing more spaces for retail and other services, results in more rental income.

6.7.9.2.6 Key Resources (KR)

If more leisure passengers would be attracted, then more space in the airport building is needed. Furthermore, more and/or larger planes are required. This might imply that slots need to be introduced.

6.7.9.2.7 Key Activities (KA)

Service level agreements have to be made and tickets and tariffs have to be integrated to make the whole scheme work. Furthermore, to attract more leisure travellers, more destinations (further away) need to be offered.

6.7.9.2.8 Key Partnerships (KP)

The airport management makes agreements with the other transport providers who provide access transport services to the airport.

6.7.9.2.9 Cost Structure (C\$)

The only (and largest) cost consists of the installation of the train stop.

Figure 6.489 provides a graphical representation of the changes in the nine building blocks of the business model (according to Osterwalder).

Key partners New partnerships between the airport and the transport providers (access modes) <ul style="list-style-type: none"> • Service level agreements • Commercial agreements 	Key Activities <ul style="list-style-type: none"> • Ticket and tariff integration • Service agreements Key Resources	Value Proposition Integration of the transport legs to make the airport better accessible and lower the congestion around the airport (by promoting the use of public transport)	Customer Relationships Offer better service to all passengers	Customer Segments Business travellers: improve service of taxi company Leisure travellers: improve service of bus company All: discount at car rental and direct train access
Cost Structure Cost of installing train stop (eventually divided between rail operator and airport)		Revenue streams <ul style="list-style-type: none"> • Better use of public transport so more tickets sold • Different revenue allocation between airport and bus-taxi-car rental companies 		

Figure 6.489: Graphical representation of nine building blocks of the business model

Source: Own composition, based on Osterwalder

6.7.9.3 *Description of proposed service (using the concept of Agents)*

In this section, the proposal of a new business model is described, using the concept of 'agents'.

6.7.9.3.1 Agents

The agents currently present at Antwerp Airport do not change with the proposal of a new business model.

6.7.9.3.2 Objectives and Goals

The objectives and goals of the agents remain the same: the passenger wants to limit his / her travel time, the transport operators want to maximise their revenue (and thus profit) and the airport wants to be well accessible.

6.7.9.3.3 Strategies

To limit the travel time, the passengers can now use the extra pre- and on-trip information. Thanks to the promotion of the public transport services, the transport operators can sell more tickets which results in more revenue and thus more profit. Thanks to the agreements with the transport operators, the airport is better accessible and the congestion on the roads surrounding the airport is lower.

6.7.9.3.4 Interactions between agents

The agents present would not change. The only real change consists of the different interactions between the agents. With the new business model, the airport management would cooperate with the different transport providers. Furthermore, the bus, taxi and car rental company would now face direct competition from the train services provider, whereas before, there was only indirect competition.

<i>Agents</i>	<i>Passenger</i>	<i>Airline</i>	<i>Airport (management)</i>	<i>Bus company</i>	<i>Taxi company</i>	<i>Car rental company</i>	<i>Train company</i>
<i>Passenger</i>	<i>No interaction</i>	<i>Commercial</i>	<i>Commercial</i>	<i>Commercial</i>	<i>Commercial</i>	<i>Commercial</i>	<i>Commercial</i>
<i>Airline</i>	<i>Commercial</i>	<i>(Only one airline present)</i>	<i>Cooperation/contractual</i>	<i>No interaction (possible cooperation)</i>	<i>No interaction (possible cooperation)</i>	<i>No interaction (possible cooperation)</i>	<i>No interaction (possible cooperation)</i>
<i>Airport (management)</i>	<i>Commercial</i>	<i>Cooperation/contractual</i>	<i>/</i>	<i>Cooperation</i>	<i>Cooperation</i>	<i>Cooperation</i>	<i>Cooperation</i>
<i>Bus company</i>	<i>Commercial</i>	<i>No interaction (possible cooperation)</i>	<i>Cooperation</i>	<i>(Only one bus company present)</i>	<i>Competition (+ possible cooperation)</i>	<i>Competition (+ possible cooperation)</i>	<i>Competition (+ possible cooperation)</i>
<i>Taxi company</i>	<i>Commercial</i>	<i>No interaction (possible cooperation)</i>	<i>Cooperation</i>	<i>Competition (+ possible cooperation)</i>	<i>Competition in between taxi companies</i>	<i>Competition (+ possible cooperation)</i>	<i>Competition (+ possible cooperation)</i>
<i>Car rental company</i>	<i>Commercial</i>	<i>No interaction (possible cooperation)</i>	<i>Cooperation</i>	<i>Competition (+ possible cooperation)</i>	<i>Competition (+ possible cooperation)</i>	<i>Competition in between car rental companies</i>	<i>Competition (+ possible cooperation)</i>
<i>Train company</i>	<i>Commercial</i>	<i>No interaction (possible cooperation)</i>	<i>Cooperation</i>	<i>Competition (+ possible cooperation)</i>	<i>Competition (+ possible cooperation)</i>	<i>Competition (+ possible cooperation)</i>	<i>(Only one train company present)</i>

Figure 6.490: Interactions between the different agents at Antwerp Airport, with proposal of new business model

Source: Own composition

6.7.9.3.5 Graphical representation

Figure 6.491 presents a graphical representation of the agents operating at (or indirectly related to) Antwerp Airport, after applying the new business model.

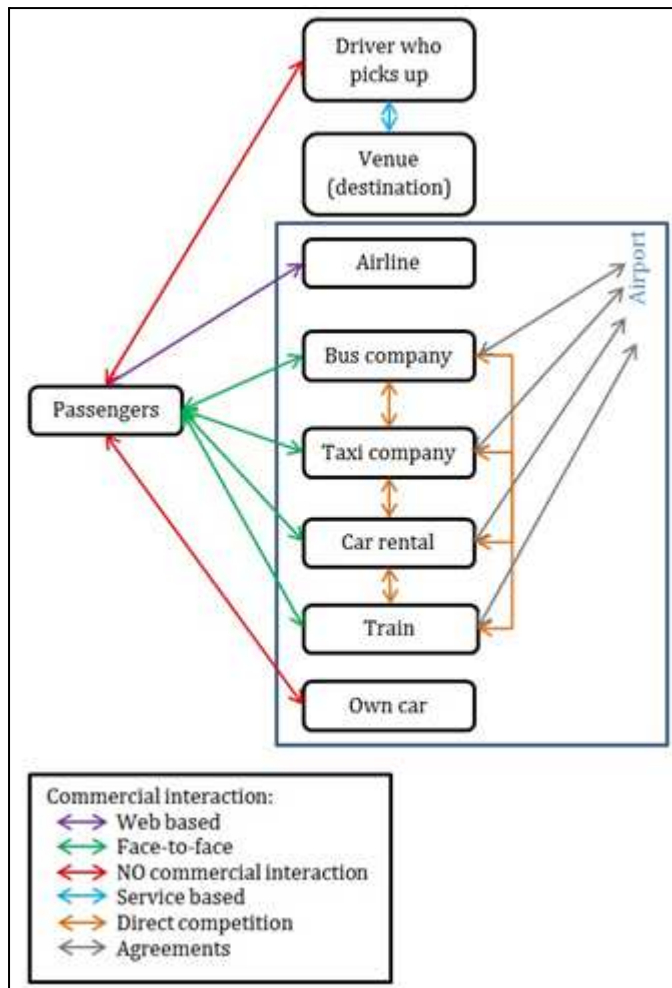


Figure 6.491: ABM conceptual presentation of the proposal of a new Business Model
Source: Own composition

6.7.9.4 Functions and Indicators to show enhancement

6.7.9.4.1 Functions of validation

As already stated before, the service level agreements and ticket/tariff integration between the airline and the other transport operators and the marketing agreements between the airport management and transport operators are changes that come without any cost. This adds to the success in the short term. The bus company would attract more customers thanks to the low tariff and the passengers would be satisfied with the improved service. Business travellers would be more keen on using the taxi if the service delivered is good. Making car rental cheaper, might not cause huge changes since the traveller has to book the car in advance, but if the airport promotes the companies on their website, also their market might grow and, consequently, their revenues might rise.

In the long run, the airport can be directly accessible by train. This makes the airport more attractive and might enlarge the market of the rail operator.

6.7.9.4.2 Indicators of validation

To indicate the advantages of the new business proposal, one can take the travel time and the travel cost into account. Next to this, the traveller also expects a good service, but this cannot be expressed numerically.

6.7.9.4.3 Methods and tools

Calculating the travel time and looking at the travel cost of each possible mode, makes it possible to compare the different travel options. If two options seem equally good, the service delivered can make the difference.

6.7.9.5 *Demonstration and Evidence of Improvement*

Currently, most passengers travelling from Antwerp Airport onwards, take their own car or a taxi. Despite of the higher cost, these modes are preferred because of the availability of the modes and the time the passengers saves travelling. For example, travelling to the city center of Antwerp is faster using the car (about 15 min.; no waiting time) than using the bus (about 20 min.; excl. waiting time). Another advantage of using taxi or own car is that those modes can drop the traveller off right where he / she has to be, while the public transport is limited to the available stops in the city.

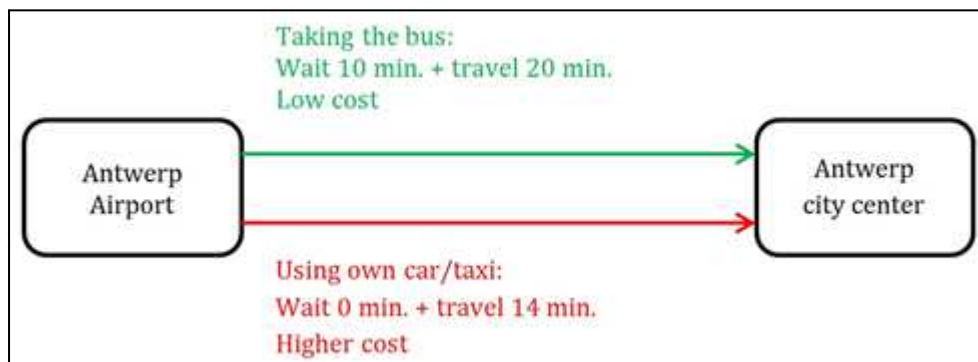


Figure 6.492: Using car vs. Using public transport to travel to Antwerp city center

Source: Own composition

If the traveller would like to travel further, for example, to Brussels city center, he / she would save a lot of time.

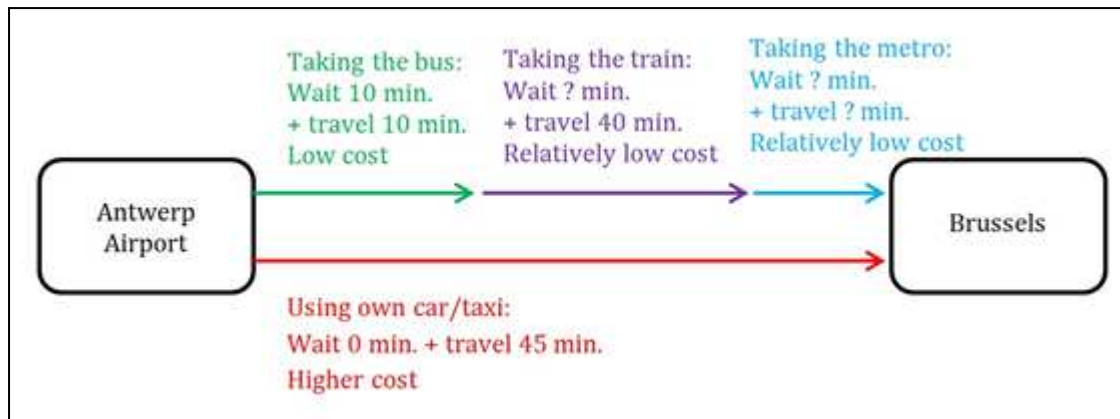


Figure 6.493: Using car vs. Using public transport to travel to Brussels
Source: Own composition

The biggest disadvantage of the car is that there is a lot of congestion on the roads surrounding Antwerp Airport. If the airport management would stimulate the use of public transport, the congestion would lower.

6.7.9.5.1 Short term

If the car use is discouraged by the airport management, then good other options (such as public transport) need to be available. Business travellers request as much comfort as possible during travelling. Furthermore, they are very time-sensitive. Leisure travellers, on the other hand, are more cost-sensitive.

At Antwerp Airport, currently there are two possible public transport modes directly available: bus and taxi. Comparing to the car, the bus is cheaper and will thus be preferred by leisure travellers. Taxi rides, however, are as available as the own car and the travel time is also about the same. To convince business travellers to take a taxi to travel further, he / she needs to be certain that the service delivered is good.

Figure 6.494 compares the travel cost and travel time of car, bus and taxi if a passenger wants to travel to the city center of Antwerp. Here, Antwerp Central Station is used as a final destination to compare the three options and it is assumed that the ride is during non-peak hours (and thus on non-congested roads).

Travelling from Antwerp Airport to Antwerp city center (here: Antwerp Central Station)			
	Travel time	Travel cost	
Own car	About 15 min.	€0,50 - €1 (gasoline) + fixed costs of owning a car + parking costs	Use of car will be discouraged, so look at other options
Taxi	About 15 min.	€12,90	→ Quickest option: preferred by business
Bus	About 20 min. + waiting time	€2	→ Cheapest option: preferred by leisure

Figure 6.494: Comparing the options of car use or public transport to travel from Antwerp Airport to Antwerp city center

Source: Own composition, based on websites Mappy.be, taxisantwerpen.be and delijn.be

If passengers want to travel further, for example, to Brussels, then taking the train is also an option.

Travelling from Antwerp Airport to Brussels (here: Brussels Central Station)			
	Travel time	Travel cost	
Own car	About 40 min.	€5 - €7 (gasoline) + fixed costs of owning a car + parking costs	Use of car will be discouraged, so look at other options
Taxi	About 40 min.	€87,70	→ Quickest option: preferred by business
Bus and train	<i>Bus from Antwerp Airport to Antwerp Berchem Station</i>		→ Cheapest option: preferred by leisure
	About 10 min.	€2	
	<i>Train from Antwerp Berchem Station to Brussels Central Station</i>		
	About 40 min.	€6,70	
	About 50 min. + waiting time	€8,70	

Figure 6.495: Comparing the options of car use or public transport to travel from Antwerp Airport to Brussels Central Station

Source: Own composition, based on websites Mappy.be, taxisantwerpen.be, delijn.be and be-rail.be

As can be seen in Figure 6.494 and Figure 6.495, if the car use is discouraged, business passengers would be tempted to use the taxi and leisure travellers would take the bus (and possibly the train) to travel to their final destination. A good service from all public transport modes is needed.

6.7.9.5.2 Long term

In the long term, a train stop might be installed next to the airport building. This would imply that the bus ride to the station of Antwerp Berchem can now be replaced by a (shorter) train ride which would lower the travel time and the travel cost, so both business and leisure travellers might be appealed.

For example, if a traveller wants to travel to Brussels, departing from Antwerp Airport, he / she would have to take the train to the station of Antwerp Berchem and from there on, travel further to Brussels. As can be seen in Figure 6.486, the travel time between Antwerp Airport and the train station of Antwerp Berchem would amount to 2 minutes by train. Figure 6.495 shows that, from the station of Antwerp Berchem, travelling to Brussels takes about 40 minutes. The disadvantage of the train is that there is some waiting involved, but if the ticket system of the airport and the train would be integrated, the train would be the cheapest option, so maybe the preferred option for the leisure traveller.

As can be seen in Figure 6.496, the taxi still is quicker than the train and maybe more comfortable since it is directly available at the airport without any waiting time. The business traveller who is highly time-sensitive will still prefer to take the taxi. The business traveller who is also cost-sensitive, will probably choose the train since both travel times do not differ as much.

Travelling from Antwerp Airport to Brussels (here: Brussels Central Station)		
	Travel time	Travel cost
Own car	About 40 min.	€5 - €7 (gasoline) + fixed costs of owning a car + parking costs
		Use of car will be discouraged, so look at other options
Taxi	About 40 min.	€87,70
		→ Quickest option: preferred by business
Train	Train from Antwerp Airport to Antwerp Berchem Station	
	About 2 min.	No extra cost if travelling in the zone of Antwerp
	Train from Antwerp Berchem Station to Brussels Central Station	
	About 40 min.	€6,70
	About 42 min. + waiting time	€6,70
		→ Cheapest option: preferred by leisure

Figure 6.496: Comparing the options of car use or public transport (with direct train connection) to travel from Antwerp Airport to Brussels Central Station

Source: Own composition, based on websites Mappy.be, taxisantwerpen.be and b-rail.be

As can be seen here, altering the accessibility of Antwerp Airport is physically possible and would be useful at Antwerp Airport. Improving the services delivered by the bus and taxi company is relatively easy to achieve without large investments needed. However, the problems concerning congestion cannot be solved easily. Encouraging passengers to use the public transport will reduce the congestion problem a bit, but not fully. Only providing a non-road mode and promoting the use of it will solve this problem a bit more. However, installing a train station implies a large cost. Therefore, examining whether installing a train station is economically viable is of crucial importance.

First, the airport management has to look at how many passengers would use the train to get to and from the airport. To calculate the potential number of rail users, it might be enlightening to look at another Belgian airport which does have direct rail access, for instance Brussels Airport. On average 17% of the passengers passing through Brussels Airport travel by train to and from the airport. Projecting this onto Antwerp Airport, this would mean that 27,683 passengers of the 162,840 passengers flying to and from Antwerp Airport in 2010 would have taken the train. Looking at monthly figures, on average 77 passengers per day would use the train to get to and from the airport. This figure is too low to persuade investors to install a train station near Antwerp Airport.

To make the train station economically viable, Antwerp Airport would have to attract more passengers. Nowadays, Antwerp Airport nowadays mainly serves business passengers so the leisure market has a lot of potential. However, if the airport management wants to attract leisure travellers, they have to alter their value proposition. For example, the one airport shop present in the airport building will not satisfy the needs of leisure travellers. Furthermore, more seating areas need to be installed and a larger check-in area is needed if more passengers want to use the airport. This all implies that the airport building has to be expanded.

As already stated, to attract more (leisure) travellers, the destinations offered have to increase. The current operating airline, CityJet, has learned from previous experience²³ that offering more destinations is not profitable for them and therefore, other airlines need to be persuaded to offer their services at Antwerp Airport. To do so, it is important that the infrastructure is good. For example, in 2001 Ryanair chose Charleroi Airport as their first hub on the European Continent because they offered a good, central location and good infrastructure. Since the fleet of Ryanair only consists of Boeing 737-airplanes, it is important that the landing strip of the new hub is long enough. At Antwerp Airport, a fully loaded Boeing 737 cannot be received. The landing strip is only 1,500 meters long and can therefore not receive large airplanes, let alone fully loaded large airplanes.

Unfortunately, expanding the landing strip is impossible. As can be seen on Figure 6.497, Antwerp Airport is located in a residential area and to elongate the landing strip, the road R11 needs to be diverted. Even if it would be completely tunneled, the size of the site is still restricted by the presence of the fort.

²³ As from March 2009, CityJet offered flights to Frankfurt. However, after only 3 months this destination was no longer offered due to low profitability.



Figure 6.497: Picture of Antwerp Airport showing the restrictions for expansion

Source: Own composition, based on Google Maps

Taking into account the physical restrictions of the site, an expansion of Antwerp Airport seems impossible. This implies that offering leisure travellers the value added they are looking for is rather difficult. Therefore, the critical mass needed for the installation of the train station will not be achieved and investors will not be inclined to finance it. This makes installing a train station at Antwerp Airport economically impossible.

6.7.9.6 Added value from the case study to the HERMES project

Antwerp Airport is accessible through private and public road transport, but the links can be improved: given the fact that the roads surrounding the airport are congested and that the service of the public transport providers leaves a lot to be desired, some alterations are needed. Improving the current access modes is difficult: providing a better service (bus and taxi) is useful, but the congestion problem is not solvable on short term.

At Antwerp Airport, there are also some missing transport links since the airport is only directly accessible by road. Providing direct rail accessibility is physically possible, but economically impossible.

Therefore, Antwerp Airport is a case study which proves that improving intermodality is not possible everywhere.

6.8 Frankfurt-Hahn Regional Airport, Germany

6.8.1 Main features of the site

Frankfurt-Hahn Airport (IATA Code: HHN) is a commercial airport located in Rhineland-Palatinate to the west of central Germany. The airport is located over 120 km to the west of the city and the International airport of Frankfurt (Figure 6.498).



Figure 6.498: Location of Frankfurt-Hahn airport

6.8.1.1.1 History of the airport

Frankfurt-Hahn Airport was a military airport (since 1951) known as Hahn Air Base that was one of the home bases of the United States Air Forces in Germany. In 1993 the airport was turned over to civil German authorities and was opened for civil flights. Since then the airport has become one of Germany's fastest growing airports especially since 1999 when the Irish low cost carrier Ryanair settled on Frankfurt-Hahn and developed the airport to one of its major airport bases. In 2002 the number of passengers exceeded the million mark, in 2003 the two million mark, in 2005 the three million mark and in 2007 the four million mark. Besides passenger services, the cargo business has developed to a second pillar of the airport and is currently ranked fifth in Germany.

6.8.1.1.2 Ownership structure

During the first years of civil operation Frankfurt-Hahn was owned and operated by public authorities. In 1999 Fraport AG a commercial airport operator, which also operates Frankfurt

International Airport (IATA Code: FRA) acquired 65% of total shares of Frankfurt-Hahn with minor shares remained with the federal states of Rhineland-Palatinate and Hesse. Fraport AG intended to transfer Frankfurt-Hahn into a profitable airport with a dedicated focus on low-cost services and as a niche airport without direct competition to FRA. First ideas to create an airport system of FRA and HHN were abandoned because of the long distance and the long-lasting travel time between both airports which would be very costly to overcome (transport infrastructure investments). The withdrawal of Fraport AG from Frankfurt-Hahn airport was initiated by the annual losses of the airport which amount to (maximum) 15.7 million Euros in 2007. As a strategic countermeasure to overcome the debts, Fraport AG proclaimed to launch a passenger fee of 3 Euro per departing passenger. Furthermore, the existing terminals were intended to be modernized and further expanded. Especially the market power of Ryanair, which threatened to relocate their Hahn base to another airport has led to the decision of Fraport AG to withdraw from Frankfurt-Hahn airport. Since January 2009 Frankfurt Hahn airport is now again owned by the federal states of Rhineland-Palatinate (82.5%) and Hesse (17.5%).

6.8.1.2 *Identification of the site*

The case-study of Frankfurt-Hahn covers all three levels of interconnectivity which are addressed in the HERMES project:

- Interfaces between different modes: air – road (– rail)
- Interfaces between different type of service of the same mode: road (public transport (bus) – private transport (car))
- Interfaces between high capacity and low capacity mode: air – private road transport/taxi

6.8.1.2.1 Transport demand/Passenger flow

Since the first civil air services at Hahn airport in 1993, the airport developed rapidly. In 2002 the number of passengers exceeded the one million mark, in 2003 the two million mark, in 2005 the three million mark and in 2007 the four million mark. In 2009 around 3.7 million passengers departed from Hahn airport (Figure 6.499).

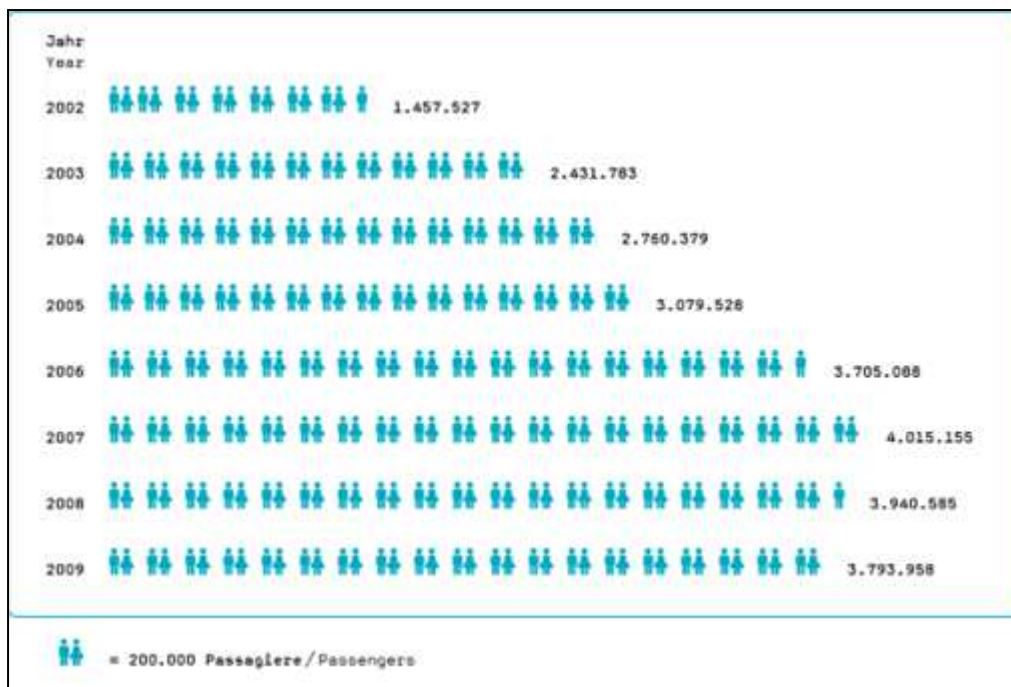


Figure 6.499: Passenger Development at Frankfurt-Hahn Airport (Frankfurt Hahn airport, 2011)

The passenger flows can be largely categorised into access/egress and (long-distance) air connections. Therefore, a detailed description of the passenger flows and main destinations is given in the mode specific sections below.

6.8.1.2.2 Services per transport mode

Ryanair, as by far the largest operating airline at Hahn airport, operates flights from HHN to its primary airports. Therefore, the passenger route network from Hahn is determined to Europe and the top 10 destinations are solely serviced by Ryanair (Figure 6.500). The network covers both long-distance and short distance destinations according to the definition in HERMES.

The distribution of passengers' destination countries shows the same picture as for the top 10 destination airports and with Italy, Spain, the United Kingdom and Germany the major service markets of Ryanair are also the key destinations from Hahn airport.

Destination	PAX (2009)	Short (SD) vs. long-distance (LD) air service
London-Stansted	313,388	SD
Berlin-Schoenefeld	261,820	SD
Rome-Ciampino	217,024	LD
Girona	181,519	LD
Bergamo-Orio al Serio	164,246	SD
Porto	126,088	LD
Palma de Mallorca	115,602	LD
Pisa-San Guisto	112,642	LD
Treviso-Sant' Angelo	108,426	SD
Dublin	102,202	LD

Figure 6.500: Top 10 destinations based on PAX 2009 (Source: Eurostat, 2011)

Figure 6.501 illustrates the distribution of destination countries from Frankfurt Hahn airport whereas Figure 6.502 displays the airport bases of Ryanair including the number of positioned airplanes at the airports. The importance of Hahn for Ryanair becomes obvious because 11 airplanes are permanently positioned at the airport making Hahn one of the top four airports for Ryanair (London-Stansted: 22 airplanes, Dublin: 15 airplanes, Madrid: 12 airplanes).

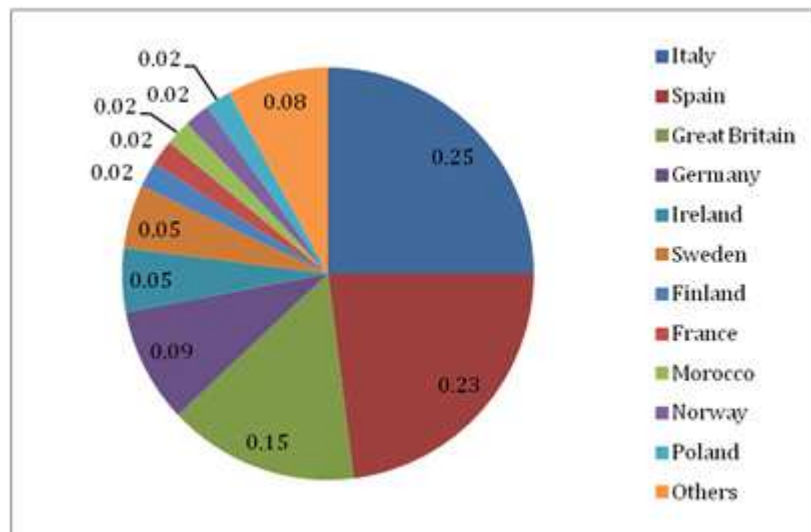


Figure 6.501: Distribution of destination countries from Frankfurt-Hahn Airport (Frankfurt Hahn airport, 2010)

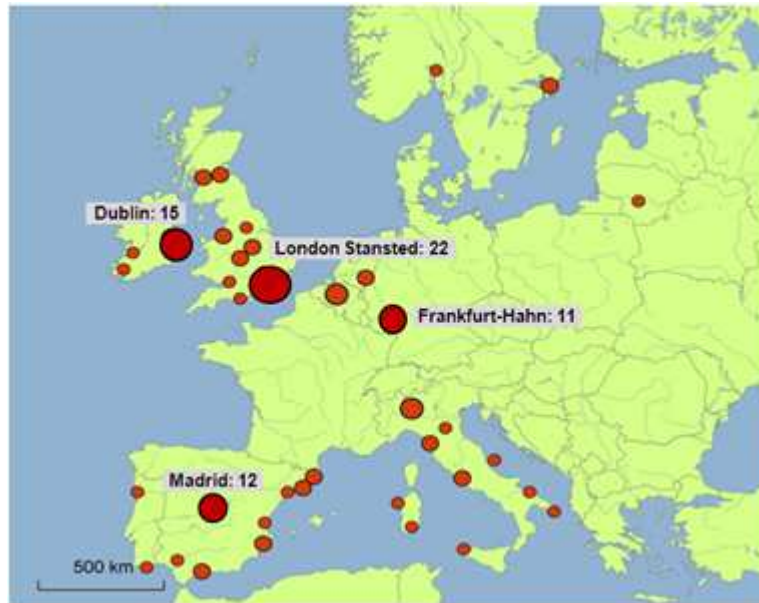


Figure 6.502: Ryanair's airport bases by number of permanently stationed airplanes (own composition based on secondary sources)

Surface transport modes are dominated by car with much smaller shares for public buses. Direct services are operated by selected bus companies from Hahn airport to surrounding cities of maximum 200 km distance. Especially large cities like Cologne (approx. one million inhabitants), Frankfurt (approx. 670,000 inhabitants), Mannheim (approx. 310,000 inhabitants) and Mainz (approx. 200,000 inhabitants) are either operated because of origin passengers from these cities or because of transfer passengers which use these cities as gateways to Hahn airport (Figure 6.503).

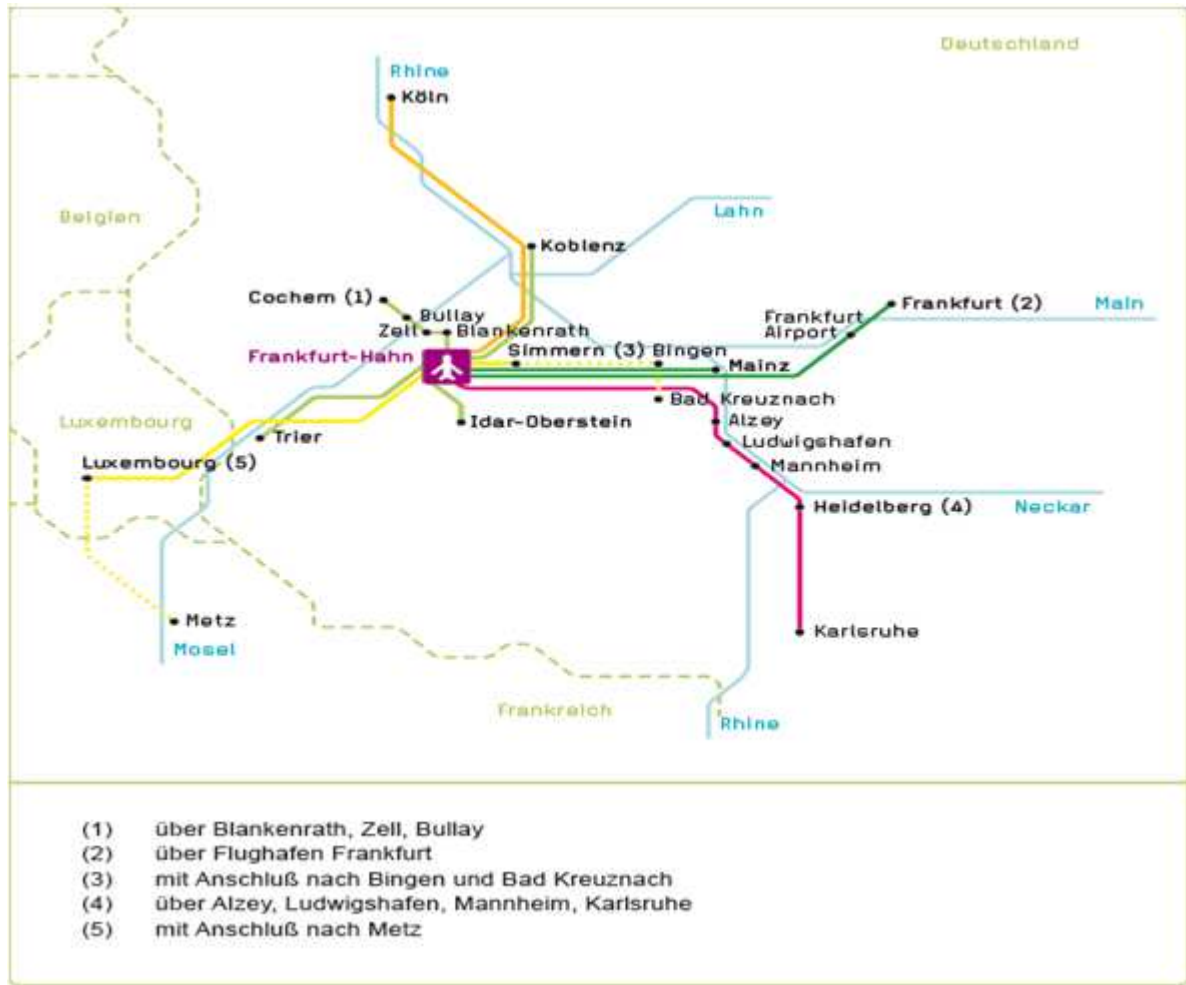


Figure 6.503: Bus network from Hahn airport (Frankfurt Hahn airport, 2011)

Figure 6.504 displays the distribution of bus passengers from departing cities by comparing the number of passengers that originate in the city (“origin in this city”) with the number of passengers that board to a bus service in the city (“start of bus trip”). Especially Frankfurt is a gateway for Hahn airport which can be explained by the location of the bus terminal at Frankfurt’s main railway station which is very well connected to the rest of Germany by fast railway services (e.g. ICE services).

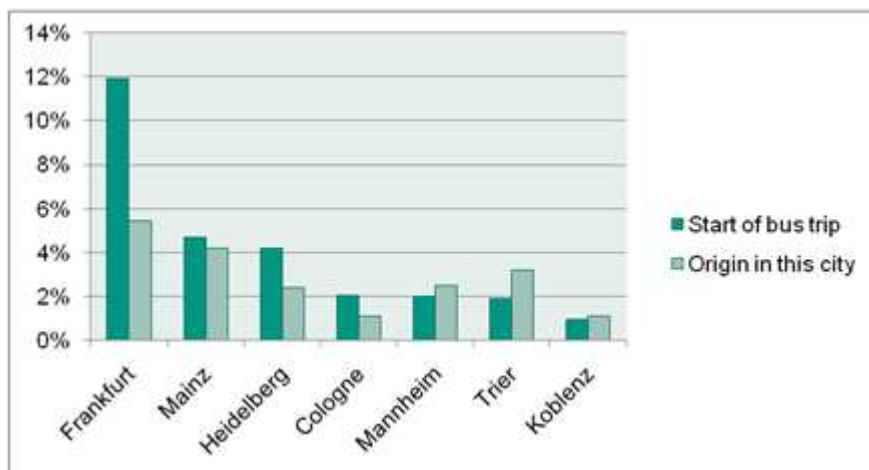


Figure 6.504: Boarding cities of bus passengers to Hahn airport (Customer survey, 2010)

6.8.2 Method for data collection

6.8.2.1 Observations and collected material

In order to describe the current level of corresponding services at the terminal, surveys and collection of data/information followed by analysis, will be performed in each Case Study.

6.8.2.1.1 Transport demand/Passenger flow

Publicly available data sources exist and are used for the present case study (e.g. Eurostat, ADV – the German Airports Association, etc.). Such data give a detailed overview into the passenger, cargo and flight movement development at Frankfurt Hahn airport. Further information on the share of business versus leisure passengers, etc. are collected and consolidated from the representative passenger survey.

6.8.2.1.2 Time data

Satisfaction with average service times (e.g. total time at the airport before departing) are extracted from the customer survey where such information are asked. Furthermore, personal site inspections have been used to verify these average data.

6.8.2.1.3 Space data

Publicly available data sources exist and have been used for the present case-study (e.g. webpage of Hahn airport). Additional information and data have been provided by the airport management and by the customer survey.

6.8.2.1.4 Information, Ticketing and Check-in Services data

Publicly available data sources exist and have been used for the present case-study (e.g. webpage of Hahn airport). Additional information and data have been provided by the airport management whereas satisfaction and relevance level of customers was provided by the customer survey.

6.8.2.2 *Customer survey*

In collaboration with Frankfurt Hahn airport a comprehensive customer survey was carried out. On the basis of a first HERMES customer survey template, a Hahn specific survey was developed with the terminal management of the airport.

6.8.2.2.1 Sample size

In total 1160 responses were used for statistical analyses and were compared with former customer surveys which have been carried out by the airport management.

6.8.2.2.2 Distribution of the questionnaires

The combined survey, which includes important issues of the HERMES research project, such as the importance of integrated tickets for the customers, a comparison between status-quo and expected service quality levels for the customers concerning information provision, travel services, facilities, etc. and alternative routes was carried out between November 15 and November 28, 2010. Such data are compared with former surveys which have been performed by the airport management on a regular basis.

6.8.2.3 *Stakeholder interviews*

A classification of the stakeholders was carried out to achieve homogenous stakeholder groups and to be able to interview one representative of every stakeholder group. Therefore, a complete picture of the interests, influences, responsibilities, co-operations, problems and challenges can be achieved for the present case-study. The interviews have been conducted as telephone interviews of approx. 30 minutes to receive a detailed and comprehensive insight into the current situation at the airport. The following topics have been addressed for the sake of HERMES project:

- History of collaboration with/at Hahn airport,
- Task at Hahn airport,
- Stake at Hahn airport (short versus long term objectives),
- Involvement in strategic airport decisions,
- Impact/influence on airport decisions,
- Leadership willingness for strategic decisions.

6.8.3 Stakeholders/Agents at the site

6.8.3.1 Objectives and Goals

In this section, the objectives and goals of the agents, relevant for this case study are described. These serve as the basis for the analysis of relationships between the different actors in the remainder of this chapter.

Federal States of Rhineland-Palatinate and Hesse (Airport owners)

The objective of the federal states of Rhineland-Palatinate and Hesse - as airport owners - is to maximise welfare and to create a business environment, which allows the operation of the airport with a minimum requirement for subsidisation.

Airport operator (Frankfurt Hahn Inc.)

The goal of Frankfurt Hahn Inc. - as airport operator - is to maximise total profits and making the airport attractive to both business partners and passengers. Therefore a main goal is to improve the accessibility of the airport and to minimize transfer times for passengers.

Passengers

The main goal of passengers is to travel cheap and fast to and from the airport and to minimise transfer times. All trips should be as smooth as possible. The necessary efforts for information search should be as low as possible.

Passenger airlines (Ryanair)

The main goal of the passenger airlines, which are mainly represented by the Irish low cost carrier Ryanair, is to maximise profits through the optimal utilization of capacities. This requires a reliably constant and high number of passengers.

Bus operators (e.g. Bohr Bus Inc.)

The goal of bus operators is to maximise profits through serving a high number of passengers.

Car rentals (e.g. Europcar)

The goal of car rentals is to maximise profits through high sales. Car rentals are therefore, as all actors, interested in high passenger numbers. Car rentals profit from a limited offer of public transport services.

6.8.3.2 *Strategies*

In this section, the current strategies of the different agents to achieve the objectives and goals described above are described. The understanding of current strategies is crucial for the interpretation of the proposed business model.

Federal states of Rhineland-Palatinate and Hesse

The federal states are able to improve the existing infrastructure by investments in regional roads and improvements of the technical and physical conditions at the airport. Such measures include the extension of the existing federal roads, the construction of easily accessible roads to and from the airport and the construction of complimentary infrastructure such as parking facilities and bus stops. Through the ability to grant permissions and driving the process of planning and approval of investments, the federal states can directly influence the infrastructural development and therefore the quality of transport services provided at and around Hahn Airport. Furthermore, by subsidising the operation of the airport, the federal states contribute to the competitiveness of the airport, which is mainly achieved through low landing fees, low rents and liberal regulations.

Airport operator (Frankfurt Hahn Inc.)

Revenues are generated from airport fees as well as from rents by shops, travel agencies, car rentals and others. In order to raise it's attractiveness to business partners the airport management needs to make the airport attractive to passengers. The main factors here are good accessibility and smooth transfers, which therefore are at the core of the airport management strategy. Improvements of accessibility are mainly achieved in collaboration with the airport owners, who are also interested in a good connectivity of the airport. The strategy so far has mainly focused on cheap (long term) parking facilities with free shuttle buses to the terminal, which make the airport particularly attractive to car users. The affordable parking has further been subject of a marketing campaign, which was particularly targeted at car users. With respect to public transport, the strategy has been to provide easy access facilities right at the terminal. As such, coach stops are located right in front of the terminal and car rental agencies have their offices conveniently located in the terminal. This also reduces the issue of transfers between modes, which is already rather small, due to the size of the airport. Since most passengers are low cost travellers comfort at the airport is regarded less important and only plays a minor role in the airport management strategy.

Passengers

Due to its rural location and the high number of cheap parking facilities, the majority of passengers currently use private cars to get to the airport. Information on parking locations and prices can be found online. The free shuttle bus service from the more distant parking lots is used frequently. Besides taxi, the only public transport services are coaches connecting the major cities in the region to the airport. Passengers usually book tickets and inform themselves on schedules and locations online via the bus operators' website. Most of them are lickered on the airport's website.

Passenger airlines (mainly Ryanair)

In order to reach a high utilization of capacities, Ryanair is focusing on a distinctive low price strategy. These low cost flights are also the main motivation for passengers to use Frankfurt Hahn airport. With respect to interconnectivity, Ryanair's strategy is to provide information on schedules to bus operators, so they can adjust their schedules to the flight plan. Furthermore, bus tickets can be bought online, however, usually at a surcharge.

Coach operators

In order to raise the attractiveness of coach services to and from the airport, the different coach operators try to adjust their schedules to the timetables of the major flights in order to reduce transfer and waiting times. Easy only ticketing is provided for all coach services, which usually connect to the main cities in the area. There number of stopovers is held low in order to reduce the trip durations.

Car rentals (e.g. Europcar)

All major car rental agencies (Alamo, Avis, Hertz Sixt, Europcar) are located in the airport terminal and operate own modern information and service desks. They all offer both online and face-to-face sale service. The parking lot is located close to the terminal which makes rental cars a comfortable alternative to public transport. Prices are at a regular level and therefore target rather passengers who demand comfort rather than low prices.

6.8.3.3 Interactions between agents

The matrix in Figure 6.505 gives an overview of the relevant agents of the business model represented though this case study. Frankfurt Hahn Inc. as airport operator takes in a central role for the coordination of interests at the airport. It provides services to passengers (e.g. signalling and information services, safety and security, cleanliness etc.) and business partners such as car rentals and cooperates with airlines and bus operators, which are the key business

partners of the airport. The federal states, which are the owners of the airport, collaborate with the airport management in planning, financing and strategic management issues. The federal states do not maintain any commercial relations with other actors at the site. Airlines, bus operators and car rentals provide services for customers and cooperate with each other (airlines with bus operators and car rentals) respectively compete against each other (bus operators and car rentals).

Agents	Federal states	Airport operator	Passengers	Passenger airlines	Bus operators	Car rentals
Federal states		collaboration				
Airport operator			provides services	cooperation, provides services	cooperation, provides services	provides services
Passengers				commercial	commercial	commercial
Passenger airlines					cooperation	cooperation
Bus operators						competition
Car rentals						

Figure 6.505: Matrix of agents in the current business model

6.8.3.4 Graphical representation

Figure 6.506 shows the interactions among agents at the airport. It can be seen that the airport management directly interacts with all different stakeholders, while the federal states do not maintain any direct relations with other stakeholders. Commercial interactions between passengers and airlines are almost entirely web-based since ticketing and check in are mainly processed via online systems. Also Bus tickets are often purchased online but can be bought also on the bus. Face-to-face interactions are prevailing between passengers and the airport management respectively the car rentals. Car rentals compete for certain customer segments.

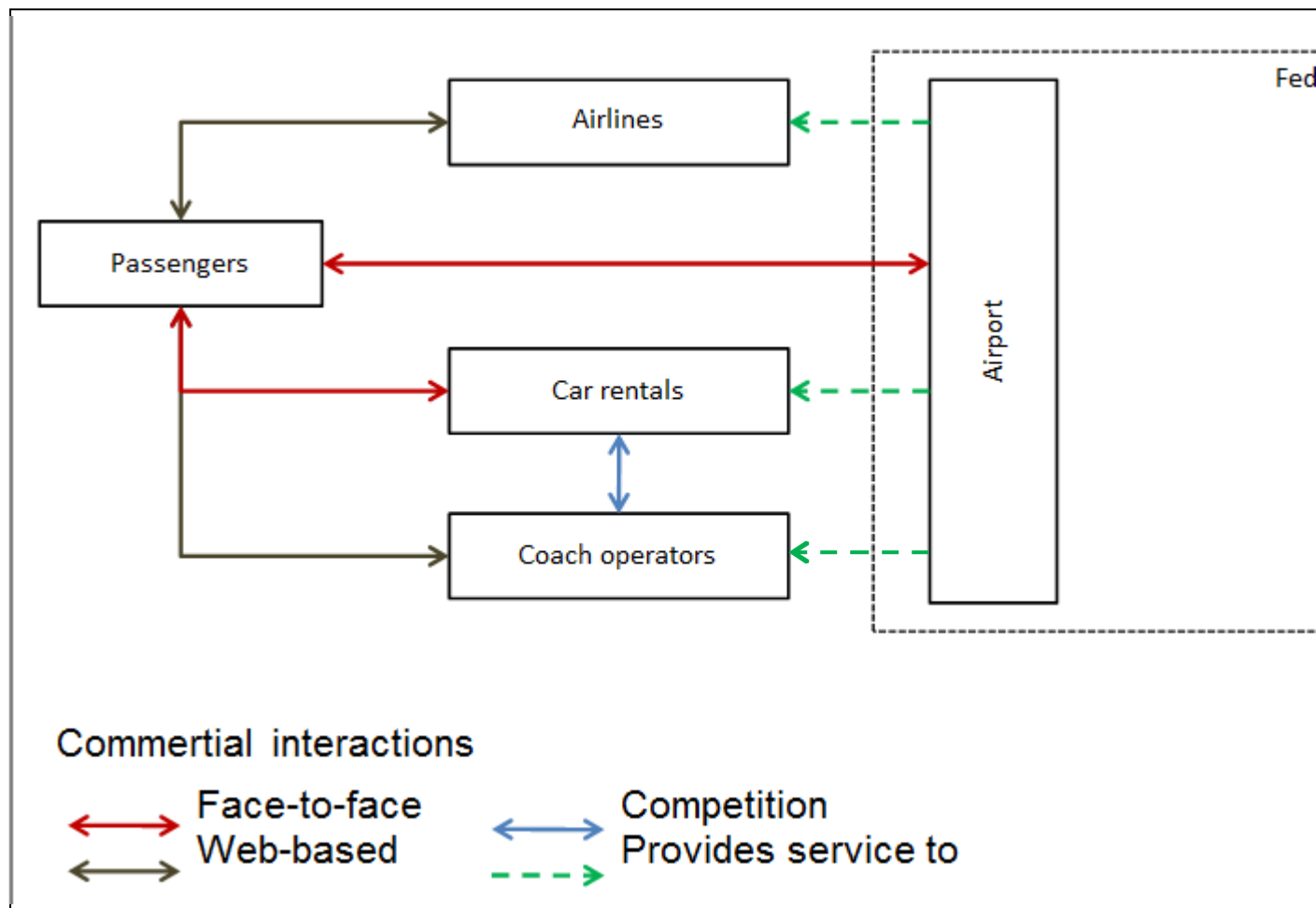


Figure 6.506: Structure of relations between agents in the current business model

6.8.4 Current short-long interconnectivity problems/opportunities

The first issue, the issue of interconnectivity, originates from the airport's rural location but also from the lack of an appropriate infrastructure, which could mitigate the problem of long distances. Infrastructure measures have so long been limited to road construction and extension. Rising passenger numbers and the potential of the airport to further extend its business are call for an extension of infrastructure, particularly for passenger transport. A rail connection is currently in the process of planning but has to pass through the process of financial planning and public approval. A long winded planning phase and financial issues are typical barriers when it comes to infrastructure investments; this also applies to Hahn airport.

The second issue is related to the number of required transfers between different modes. Since Hahn airport is currently depending on an effectively operating road infrastructure, accessibility to the airport via public transport services is currently limited to buses. Because most bus services are direct services without en-route stops the possibilities to get on these buses is

restricted for passengers. Public transport users travelling to or from areas, which are not directly connected to one of stops of the long distance bus services are dependent on connecting transport services, which are usually local trains, metro or local buses. In order to get to the long distance bus stops often several mode changes are necessary, which leads to an increased complexity and considerable planning effort. The high share of passengers using private cars is therefore not surprising.

6.8.5 Current value proposition

The case-study of Frankfurt-Hahn covers all three levels of interconnectivity which will be addressed in the HERMES project:

- Interfaces between different modes: air – road (- rail)
- Interfaces between different type of service of the same mode: road (public transport (bus) – private transport (car))
- Interfaces between high capacity and low capacity mode: air – private road transport/taxi

Frankfurt Hahn airport is currently depending on an effective operating road infrastructure as railway is currently not operating to Hahn airport. Therefore, accessibility to the airport is limited to private transport modes where car is the predominant transport mode or to public transport services that are currently limited to buses. In terms of intermodality and interconnectivity the business model was so far focused exclusively on road transport. The strategy has been to use the benefits of the small size of the airport, which assures short distances in and around the terminal and the extensive space of the former military ground, which can be used for parking facilities. Since a high percentage of a passengers used private cars, the airports interconnectivity strategy particularly targeted car users by providing cheap parking and free shuttle buses from the more distant parking facilities.

6.8.6 Description of current business model

According to Osterwalder (2004) there are nine building blocks Customer Segments (CS), Value Propositions (VP), Channels (CH), Customer Relationships (CR), Revenue Streams (R\$), Key Resources (KR), Key Activities (KA), Key Partnerships (KP) and Cost Structure (C\$).

6.8.6.1 Customer Segments (CS)

The Customer Segments in the focus of the current case study are air passengers using the airport Frankfurt-Hahn as origin and/ or destination airport. Since the airport is mainly operated by low cost passenger airlines, most of the air passengers represent a very price-sensitive demand segment. The customer segment is further described by the following analyses.

As described in previous chapter, the number of passengers has seen a high increase starting at 1.4 million in 2002 and reaching over 4 million in 2007. During the financial crisis, the numbers have gone down but were at a still high level with 3.8 million in 2009.

The top five destinations are London-Stansted, Berlin-Schoenefeld, Rome-Ciampino, Girona and Bergamo-Orio al Serio (Figure 6.500). The main destination countries have been Italy, Spain, UK and Germany (Figure 6.501).

The age structure documents that especially young passengers use the airport because passengers between 20 and 29 are the major customers at the airport (Figure 6.507). A comparison between the age distribution at Hahn airport with the German age distribution proof the specific characteristics of the airport's customers.

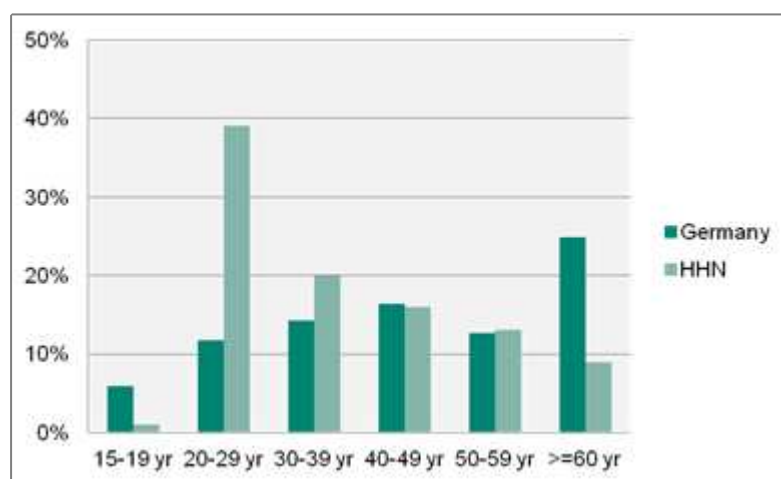


Figure 6.507: Age distribution of Hahn airport's passengers vs. German population (Customer survey, 2010)

In accord with the former observation of the age structure at Hahn airport is also the trip purpose of passengers. Young passengers use Hahn as airport for leisure trips (e.g. vacation or family visit). Business customers which are a primary segment especially of airports only play a minor role at Hahn airport. The self-image of Hahn is a low cost airport which mainly serves price sensitive customers which is underlined by the trip purpose distribution (Figure 6.508).

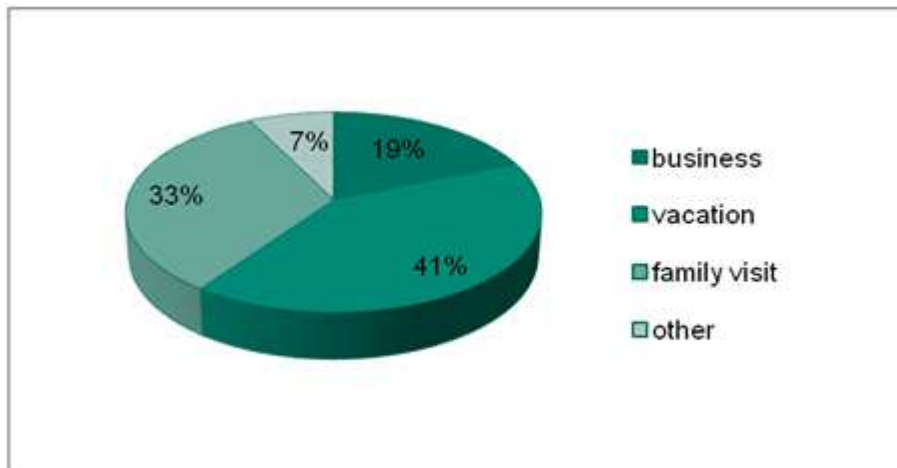


Figure 6.508: Trip purpose of Hahn airport's passengers (Customer survey, 2010)

The distribution of flights at a representative Monday can be observed from Figure 6.509. Departure peaks are in the early morning where the positioned aircrafts at Hahn airport depart. These airplanes return in the late evenings for the last time. Because of the 24h operation at Hahn airport the last arrival wave (return of flights) is at the latest convenient time for passengers at the day, just before midnight.

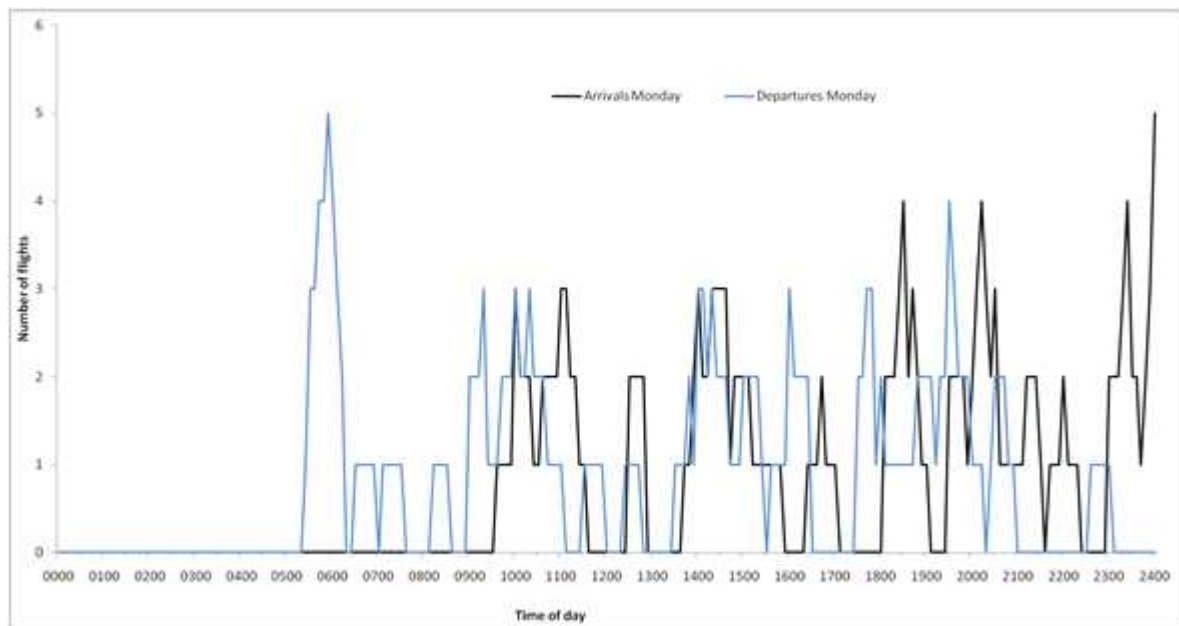


Figure 6.509: Number of flights from Hahn airport on Mondays (Frankfurt Hahn airport, 2009)

6.8.6.2 Value Proposition (VP)

The Value Proposition in the core of this case study is the improvement of accessibility of the Frankfurt-Hahn airport by public transport modes. The enhancement of access/ egress by public transport modes is characterized by the introduction of a new mode: while in presence access/ egress is ensured by coach services, in the future also rail services will operate the airport. This improvement will result in a wider range of choice and higher frequencies for air passengers to reach the airport by public transport modes.

The primary transport mode at an airport is air transport. Both short- and long-distance air services are operated by the airlines. From the top 10 destinations of Hahn airport displayed in Figure 6.500 it becomes obvious that around half of these destinations are in a corridor of short distance (defined as <700km within HERMES). The same can be observed for the remaining destinations (not illustrated in Table 1) from Hahn airport but with a stronger focus on long-distance services.

Air services are connected to surface transport modes at airports and Frankfurt Hahn airport is depending on an effective road infrastructure because railway services are currently not operated to Hahn airport. Therefore, the adjacent federal road is under construction to achieve a high service quality for passengers (and freight) to/from the airport. (Partly) Private bus operators offer public services from (to) the airport to (from) the hinterland (up to 200 km) which has however a much lower market share than private car use.

6.8.6.3 Channels (CH)

The present Channels to spread information are as follows:

- website of Frankfurt-Hahn airport for parking issues, punctuality of departure/arrival flights, access / egress opportunities from Hahn airport, terminal maps, hotels, etc.
- information desk at Frankfurt-Hahn airport for detailed face-to-face information
- websides of transport operators (e.g. Ryanair, bus operators, etc.)

The young passenger segment of Hahn airport as well as the business strategy of the operating airlines explains the high share of Internet bookings. Ryanair, Wizz Air and Iceland Express, the leading airlines at Hahn airport, distribute their tickets mainly via the Internet (Figure 6.510). Contrarily, bus operators still use the traditional distribution channel and sell their tickets in the bus and at the airport. As prices are fixed per journey (in contrast to air service prices) the distribution channel is effective for passengers and service operators. Combined tickets are currently not offered to customers.

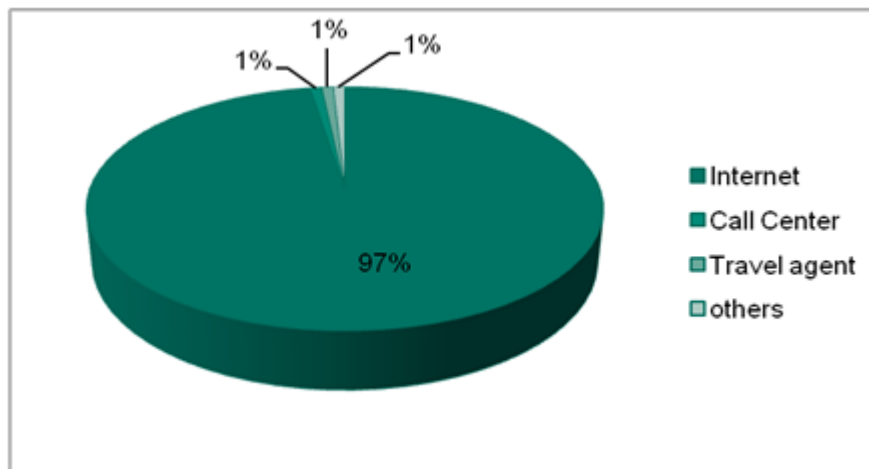


Figure 6.510: Distribution channels of transport services at Hahn airport (Customer survey, 2010)

6.8.6.4 Customer Relationships (CR)

Since the demand segment is represented by highly price-sensitive customers, Customer Relationship programs do not play a role and are not offered by the air transport operators (most LCC do not offer fidelity programs). Hahn airport offers declining parking prices depending on the duration of parking (hours vs. days and weeks) which are further differentiated based on the distance of the park deck to the terminal but a fidelity program is also not applied for car users.

6.8.6.5 Revenue Streams (R\$)

The Revenue Streams are – from the viewpoint of passengers to the public transport operators and airlines - represented by revenues of ticket sales. Tickets are purchased directly from and paid to the respective transport operator without involvement of Hahn airport. Hahn airport itself has two major revenue streams, namely aviation and non-aviation revenues. Aviation revenues include landing fees, passenger charges, etc. whereas non-aviation revenues incorporate payment of rents (e.g. shops, duty free, transport operators, conference centre, etc.). In the past, both revenue streams have not been sufficed to cover Hahn airport's expenses that the airport has been subsidised by its owners.

6.8.6.6 Key Resources (KR)

The total area of the former military air base is now managed by the Frankfurt-Hahn airport cooperation and amounts to 640 hectares. The area consists of the airport, parking spaces, office buildings, a conference centre, professional training centres and a golf course. The following information focus on the case study related infrastructure only.

The runway is 3,800 meter long, making Hahn airport B747 compatible so that Hahn is a valuable alternative for cargo operators, which is supported by the 24 hour operation possibility.

Hahn airport is a prototype of a low-cost airport, which is characterized by focusing on the basic needs of an airport instead of creating a status symbol. Investment costs of such a low-cost terminal account to 5 Euro per annual passenger and a capacity for 5 million passengers was created for 17 million Euro (German average: 100 million Euro). The terminal consists of two interconnected passenger terminals that are directly located adjacent to the apron. Short distances and low cost solutions (e.g. no jet bridges) are the primary objectives of the airport to be able to offer low landing and passenger charges.

The former military base of Frankfurt Hahn has been built because of strategic reasons of the post World War II period rather than because of civil air passenger behaviour or air freight needs. Distances between the airport and the closest business centres, such as the Rhine-Main region (i.e. Frankfurt, Mainz, Wiesbaden) or the Rhineland (i.e. Cologne, Düsseldorf, etc.) are therefore far (at least 100 kilometre). Road transport is the predominant transport mode since a rail connection currently does not exist. Plans exist to reactivate a railroad track, which had been decommissioned before the airport was transferred into a civil airport (see proposal in previous chapter).

6.8.6.7 *Key Activities (KA)*

Frankfurt Hahn links air services with surface access / egress transport services. Therefore, the Key Activity of Hahn airport in the scope of the interconnectivity issue of the case study is the provision of smooth and fast access to and egress from the airport. Public transport modes, which are at the centre of the HERMES project are currently only covered by bus and (to a small extend) taxi. In order to facilitate the transfer between modes, Hahn airport tries to optimise the provision of information on different modes (e.g. via its website) and by providing close by spaces for transport service.

6.8.6.8 *Key Partnerships (KP)*

The key partner of the public transport operators at the airport is the airport terminal management which is involved in the provision of physical access to the airport terminal and responsible for organisational matters (e.g. bus stops, parking facilities, station, etc.).

Coach operators adjust their schedule to arrival and departure of flights. Thus, the airline operating companies could be regarded as a partner. The railway company will operate services on behalf of regional public entities, by integrating their services with other rail services (e.g. connecting Frankfurt-Hahn to long-distance rail services). Therefore, key partners of the railway company are regional public entities that subsidise the rail operations, as well as other railway companies.

6.8.6.9 *Cost Structure (C\$)*

Frankfurt Hahn provides infrastructure for airlines which are mainly operating low-cost services. The airport is not limited to such airlines but the terminal structure, its facilities, the surrounding hotels, the access / egress situation, etc. underline this business focus. A focus on price-sensitive customers necessarily determines the required cost structure for a sustainable business success, namely a minimizing cost approach. Value creation is not dignified by price-sensitive passengers because extra features come with costs that need to be reimbursed which is out of scope of Hahn airport.

6.8.7 Current level of quality of services and customer satisfaction

6.8.7.1 Description general information about the passenger²⁴

The importance of car as access/ egress mode to and from the airport is illustrated in Figure 6.511 and with over 50% overwhelming. Bus as the only public transport alternative to Hahn airport is has a much smaller share with 33% and further transport alternatives can be neglected for the objective of the present study. This vertical observation which has been collected within a week in November 2011 can also be proofed over the last years (Figure 6.512). Car has always been the primary transport mode to/ from Hahn airport. During the years when Hahn airport was operated and owned by Fraport AG, the airport management of Frankfurt International airport, a cost-covering medium-term strategy was implemented at Hahn airport. Part of this strategy was a stepwise increase of the parking charges at Hahn airport to increase non-aviation revenues. The impacts of this strategy are also detected in Figure 6.512 with a decrease of car use to the airport between 2006 and 2009. Since 2009 Hahn airport is again owned and operated by public bodies, one of the first decisions after re-nationalization of the airport was the reduction of parking charges. The impact of this strategy can be observed in Figure 6.512: since 2009 the mode share of passenger cars as access/ egress mode has increased. These observations and trends support the focus on accessibility as analysis for improvement of interconnectivity.

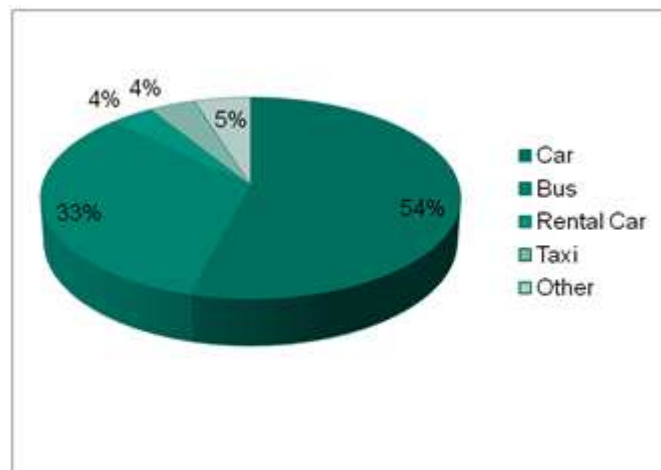


Figure 6.511: Modal split to/from Hahn airport (one week observation) (Customer survey, 2010)

Comparing the above mentioned results with other German airports (Figure 6.513) shows the outstanding situation at Hahn airport and especially the large share of bus service users. Car (Pkw) use is for all airports (except Berlin-Regel, TXL, and Munich, MUC) above 50%. Thus, more

²⁴ Detailed information on general statistics about the passengers has already been given in chapter **Error! Reference source not found.** and is not repeated here.

than every second passenger uses car as access/ egress transportation mode. Buses (scheduled bus + charter bus) have a modal split between 1.1% (Düsseldorf International, DUS) and 19% (Berlin-Tegel, TXL). It becomes obvious that in case that no railway access (Bahn) is provided (e.g. TXL, Hamburg, HAM), the number of bus travellers is much higher than for airports with railway services. Only Bremen (BRE) is an exception from this rule of thumb because of its city airport, making Taxi and pick-up drives affordable.

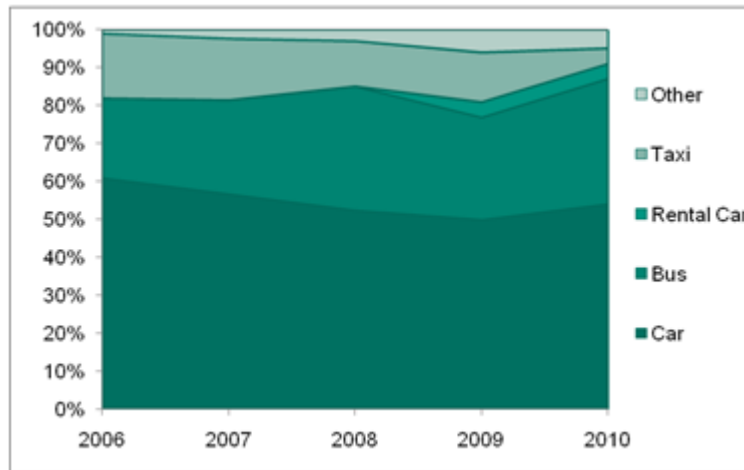


Figure 6.512: Modal split to/from Hahn airport (time perspective) (Customer survey, 2010)

Figure 6.513: Access/ egress modal split at German airport (Sterzenbach, 2003²⁵)

Airport	Car	Taxi	Rented car	Motorised private transport	Bus	Coach	Train	Public Transport	Others
TXL ²⁶	36.1	39.7	3.7	79.5	18.7	0.3	-	19.0	1.5
BRE ²⁷	69.0	20.0	3.0	92.0	3.0	3.0	-	6.0	1.0
DUS ²⁸	56.0	18.5	1.0	78.8	1.1	-	18.3	19.4	1.8
FRA ²⁹	50.0	16.0	4.0	70.0	1.0	6.0	21.0	28.0	2.0
HAM ³⁰	50.0	36.0	4.0	90.0	10.0	-	-	10.0	0
MUC ³¹	46.0	10.0	8.0	64.0	4.0	4.0	28.0	36.0	-

²⁵ Data are of 1999. It should be noticed that several infrastructure investments have been conducted since then which have changed the present situation.

²⁶ Berlin Tegel airport

²⁷ City airport Bremen

²⁸ Düsseldorf International airport

²⁹ Frankfurt am Main airport

³⁰ Hamburg Airport

³¹ Munich Airport Franz Josef Strauß

6.8.7.2 Travel demand/Passenger flow³²

The current level of satisfaction with direct services is illustrated in Figure 6.514. In average customers evaluate direct services with 1.98³³ (standard deviation: 0.89) assigning a high level of service to Hahn airport. Ryanair, Wizz Air and IcelandExpress that operate from Hahn airport, focus on direct rather than transfer (hub) services that a large number of direct services is operated from Hahn airport (approx. 50 destinations).

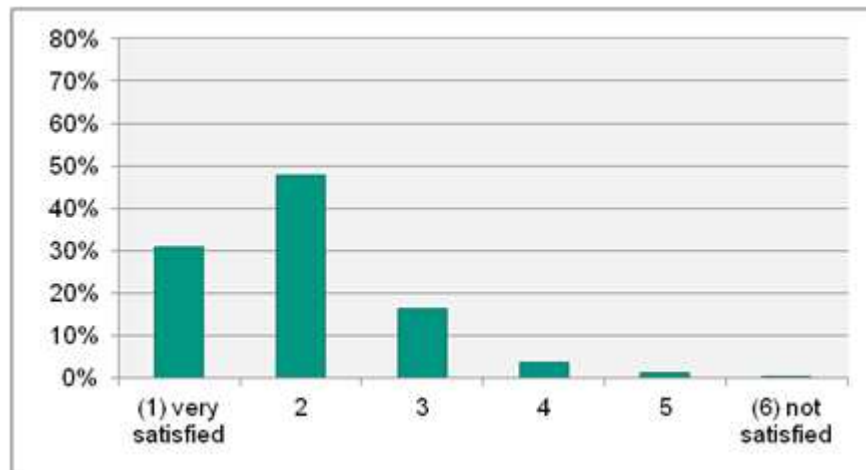


Figure 6.514: Satisfaction with direct air services from Hahn airport (Customer survey, 2010)

6.8.7.3 Time

The primary disadvantage of Hahn airport is its location and its accessibility, especially with public services (e.g. bus, railway). This issue is also reflected by the satisfaction level on travel time to the airport (Figure 6.515), which is in average evaluated with 2.92 (standard deviation: 1.35). This rating supports the focus on accessibility as analysis for improvement of interconnectivity.

³² Data on travel demand and passenger flows has already been discussed in Chapter 6.8.1.2 and is not repeated here.

³³ The survey was based on a six-grade-ordinal-scale where 1 stands for “very satisfied” and 6 for “not satisfied”.

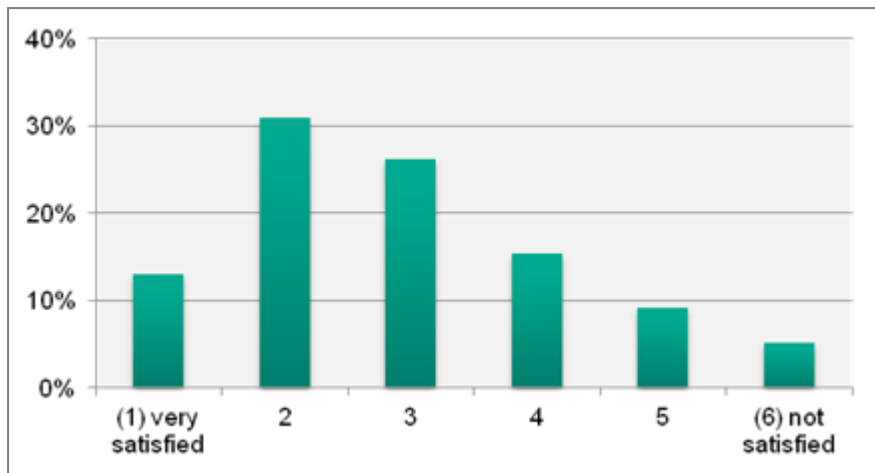


Figure 6.515: Satisfaction with travel time to the airport (airport accessibility) (Customer survey, 2010)

Trans-boarding time at Hahn airport was asked and grouped into five categories (Figure 6.516). Almost 60% of customers arrive more than 90 minutes before departure at the airport to have some time buffer for the journey to the airport, check-in, security checks, etc. Especially the journey to the airport seems to be risky, as distances at the airport are determined by the customers as very satisfactory (see previous chapters for further details).

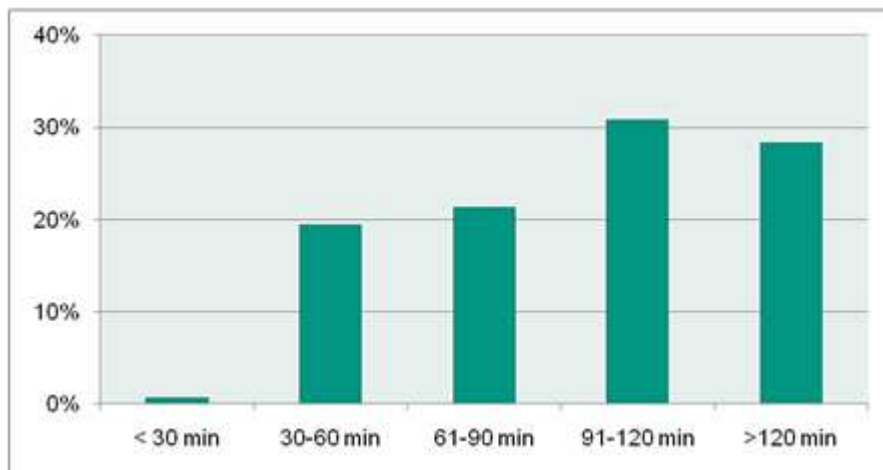


Figure 6.516: Waiting at the airport before departure (Customer survey, 2010)

Contrarily to the satisfaction with travel time to the airport are service times at baggage check-in with an average satisfaction level of 1.6 (standard deviation: 0.71) (Figure 6.517). LCC and especially Ryanair aim at minimizing passenger's baggage by levying a service charge for each piece of baggage. Hand luggage is still free of charge that passengers increased resign from registering baggage. Therefore, waiting times are rather short at LCC airports which can be proved herewith.

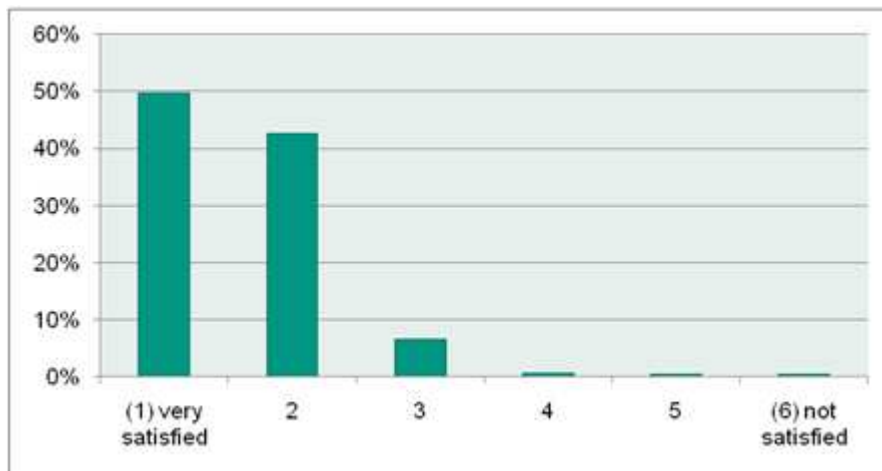


Figure 6.517: Satisfaction with waiting times at baggage check-in (Customer survey, 2010)

6.8.7.4 Space

Interconnectivity on a physical level is reached by the objective of the airport operator to minimize walking distances from the gates to the parking areas or respectively to the bus station. Figure 6.518 illustrates the terminal structure of Hahn airport and displays the short distances within the terminal. The terminal provides all required features for air services, such as gates, customs, check-in, etc. as well as some convenient amenities for the passengers, such as restaurants, duty-free, car rentals, etc. Based on the business strategy of Hahn airport to offer cost effective solutions for its price-sensitive customers no advanced value creation amenities are provided by Hahn airport (e.g. selection of lounge, showers, wellness centre) and are also not asked by the passengers.



Figure 6.518: Terminal structure of Frankfurt-Hahn airport (Frankfurt Hahn airport, 2011)

Short distances at the airport are not only achieved in physical terms but also passengers' perceptions are very satisfactory with the current situation. In average a satisfaction level of 1.73 (standard deviation: 0.77) is achieved which does not require any action by the airport management (Figure 6.519).

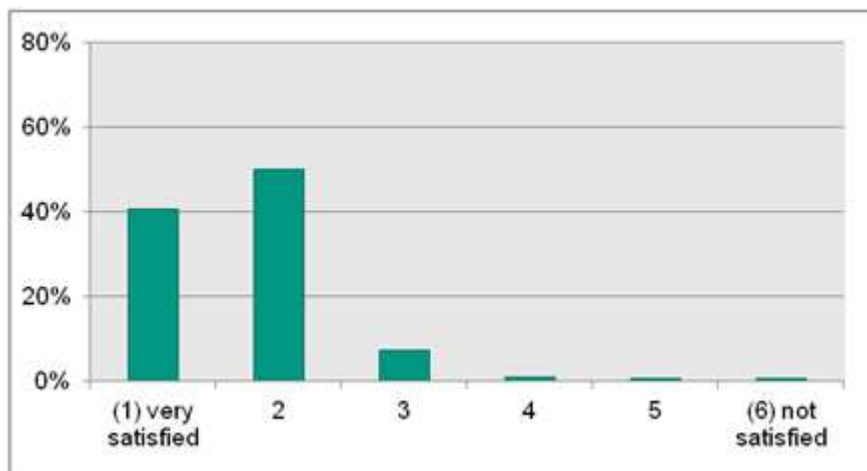


Figure 6.519: Satisfaction with distances at the airport (Customer survey, 2010)

6.8.7.5 Information and signposting

Overall satisfaction with signposting at Hahn airport is very high. Customers feel extensively informed by the airport which is achieved by screens as well as information counter and 80% of all customers are satisfied with the measures of the airport management (Figure 6.520). The under-average size of the airport (one terminal complex only), the very short distances within and around the airport as well as the comprehensive waiting time of passengers before departure might encourage the customers' rating.

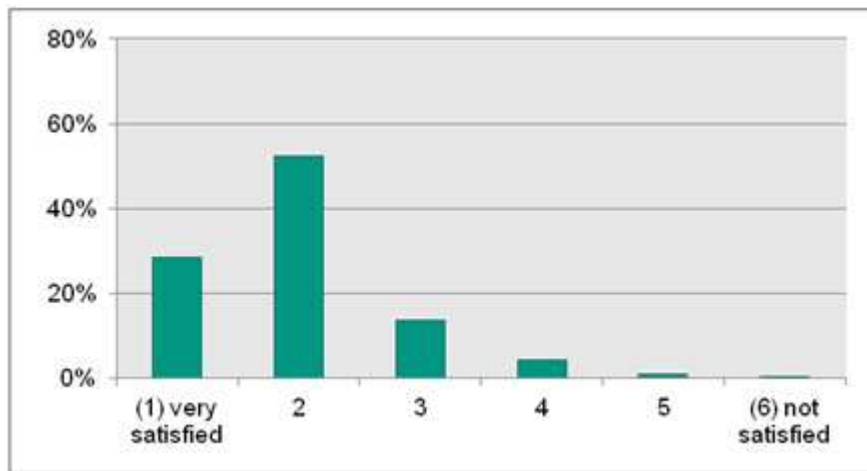


Figure 6.520: Satisfaction with signposting at Hahn airport (Customer survey, 2010)

Satisfaction level with the airport's staff is also very high (average: 1.87, standard deviation: 0.8) making the airport a friendly environment for its customers (Figure 6.521).

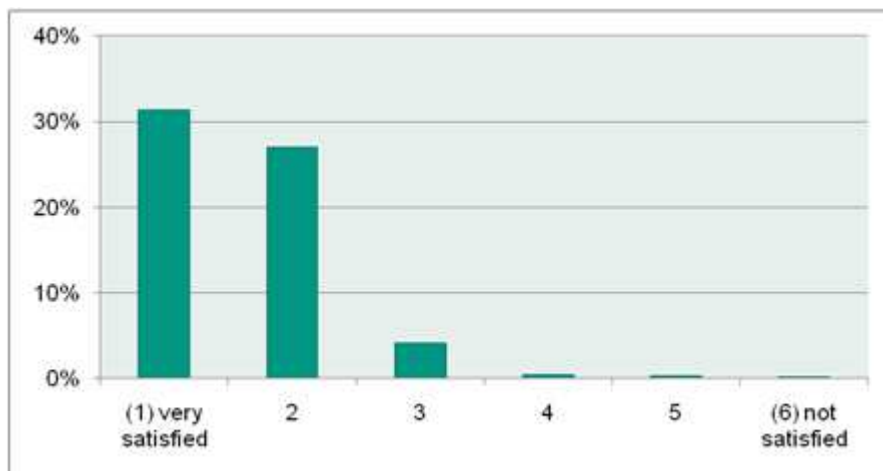


Figure 6.521: Satisfaction with friendliness of airport staff (Customer survey, 2010)

6.8.7.6 Added value at the site

Restaurants, shops, duty-free, etc. are essential parts of every airport as revenue source for the airport management and as amenities for customers' waiting times. As seen before customers arrive at the airport more than one hour before departure and even longer waiting times are very common at Hahn airport. Therefore, the satisfaction level with the airport's leisure time facilities might reduce the waiting time perception for the customers.

As shown in Figure 6.522, customers are satisfied by the variety of shops at the airport but with lower absolute satisfaction levels compared to the former analyzed categories (e.g. satisfaction with friendliness, space and signposting). The price-sensitive passengers of Hahn airport are critically evaluating the price level of the shops. Around 60% of customers are unsatisfied (≥ 3) with the present shop prices but which could have been expected because of the customer's objectives to choose Hahn airport (fare prices).

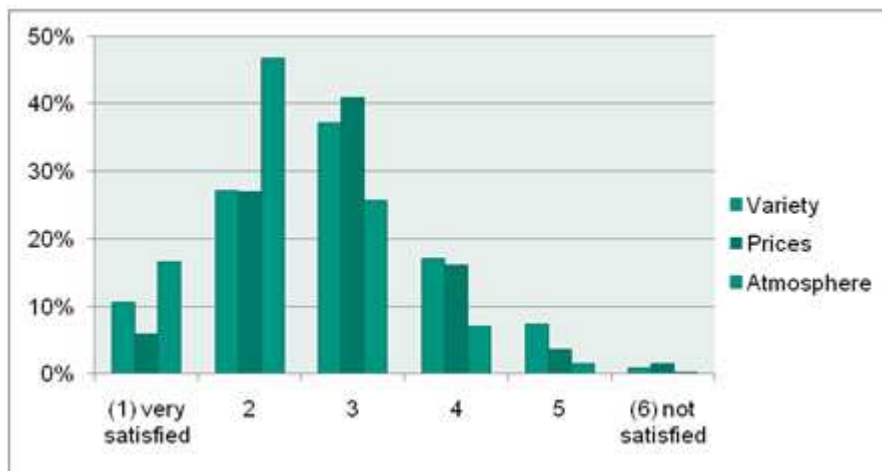


Figure 6.522: Satisfaction with shops at Hahn airport (Customer survey, 2010)

The present situation concerning restaurants is in a satisfactory manner (Figure 6.523) because variety and atmosphere of Hahn's restaurants is above average (≤ 3). More than every second customer rate variety and atmosphere with at least 2, which can be regarded as good performance for the circumstances of a LCC airport.

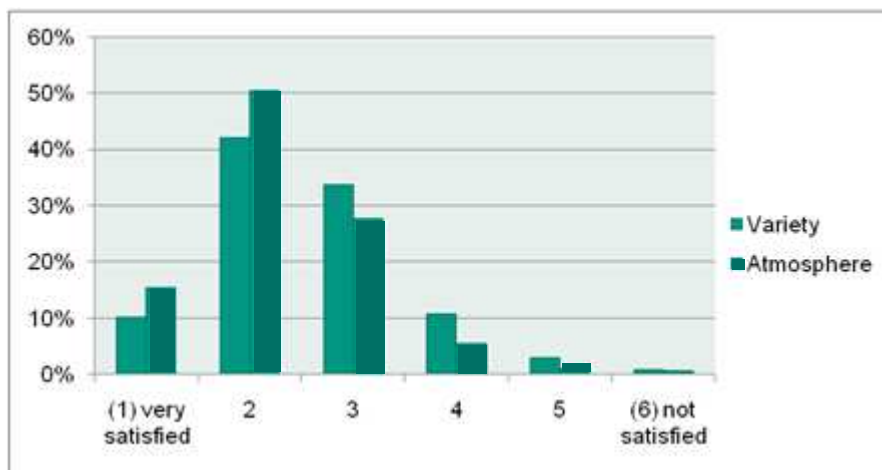


Figure 6.523: Satisfaction with restaurants at Hahn airport (Customer survey, 2010)

6.8.8 Analysis for improvement of interconnectivity

6.8.8.1 Comparison between customers and stakeholders

The current level of quality at Hahn airport and especially the customers' satisfaction with space, signposting, added values, friendliness of staff, waiting times, direct services etc. is very high and improvements are only possible on a very high level but not required by the customers. The overall satisfaction is illustrated in Figure 6.524 and it becomes obvious that overall satisfaction is high at Hahn airport. The same can be observed when looking at specific user groups, namely business travellers, frequent flyers in general and Hahn airport frequent flyers (Figure 6.525). The satisfaction level of all user groups are very similar and even business travellers which are extremely time sensitive evaluate Hahn airport well.

Still on an acceptable satisfactory level but with lower absolute values is the accessibility situation of Hahn airport. Customers perceive the access / egress situation as time consuming and not very satisfactory for an airport. Also stakeholders at the site argue for an improvement of the accessibility as passenger numbers were constantly growing over the recent years. Therefore, the present improvement analysis focuses on the primary dissatisfaction issue, namely the accessibility situation of Hahn airport.

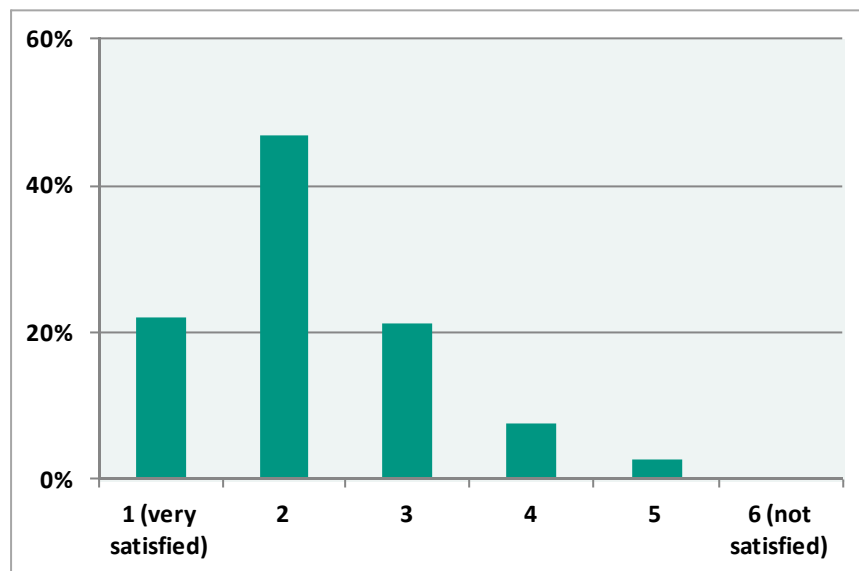


Figure 6.524: Overall satisfaction with Hahn airport (Customer survey, 2010)

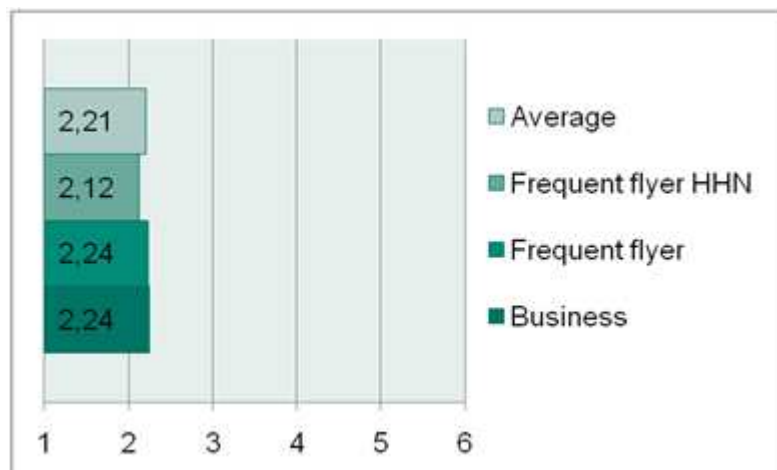


Figure 6.525: Overall satisfaction of selected user groups with Hahn airport (Customer survey, 2010)

6.8.8.2 Validation of findings in WP3/WP4

The issue of accessibility originates from the airport's rural location but also from the lack of an appropriate infrastructure, which could mitigate the problem of long distances. Hence, the gaps identified in this case study are related to Cluster 1 – The challenge of improving physical interfaces – of the barrier analysis conducted in HERMES Work Package 4 (Fluhrer, Szimba and Siegele, 2011). Infrastructure measures have so long been limited to road construction and extension. Rising passenger numbers and the potential of the airport to further extend its business are call for an extension of infrastructure, particularly for passenger transport. A rail connection is currently in the process of planning but has to pass through the process of financial planning and public approval. A long winded planning phase and financial issues are typical barriers when it comes to infrastructure investments; this also applies to Hahn airport.

6.8.8.3 Missing links and new Value Proposition

Frankfurt Hahn airport is currently depending on an effective operating road infrastructure as railway is currently not operating to Hahn airport and no railway tracks are serviceable to the airport. The adjacent federal road is currently under construction to achieve a higher service quality for passengers and freight to/ from the airport. Bus operators offer public services from (to) the airport to (from) the hinterland (up to 200 km) which has however a much lower market share than private car use.

In order to improve the accessibility with public transport modes it is planned to reactivate and extend an existing rail track to connect the airport to the regional and over-regional rail network. Approximately 60 km of inoperative tracks need to be repaired for usage. Furthermore, around ten kilometres of tracks need to be double-tracked as well as an airport station at Hahn needs to be built. In total approx. 95 million Euro of investment costs are

necessary for the connection of Hahn airport to the German railway network. This improvement of interconnectivity is critically reviewed in the following.

Figure 6.526 displays the current situation of Hahn airport and it becomes obvious that close-by alternatives for access to railway do not exist. The reactivated tracks enable a direct connection to Bingen (Rhein) Central Station (red box) or even further to Mainz Central Station (blue box) (via Bingen Central Station) which is directly connected to the German long-distance network of Deutsche Bahn AG (InterCityExpress, InterCity connections). Current information suggest that every hour one train departs from Hahn to Mainz Central Station and every second hour one further train to Bingen Central Station. Compared to the present situation with bus services frequencies will increase significantly from 10 to 20 (at least on the relationship between Hahn airport and Mainz Central Station).

With respect to travel times and ticket prices, no improvements are expected compared to the existing transport modes. However, a number of benefits are expected, which are listed below:

- Better accessibility of municipalities in the catchment area of Hahn airport because of en-route stops of the railway services
- Higher reliability of services
- Higher service frequencies
- Higher flexibility because of higher service frequencies
- Improvement of comfort.



Figure 6.526: Regional railway network around Hahn airport (based on Rheinland-Pfalz-Tackt³⁴)

³⁴ See <http://www.der-takt.de/ueber-den-takt/takt-2015/streckenreaktivierung-2015/>

6.8.9 Actions for improvement of interconnectivity

6.8.9.1 Proposal

When the former military airport was opened for public services a discussion on an effective accessibility of Hahn airport emerged. From the start, both road and rail modes were part of the discussions. However, from the beginning until now, only the already existing road connection in form of a federal road, which passes by the airport and links the airport to the German motorway network, has been used. Busses, cars as well as trucks for freight delivery to Hahn airport use the federal road and infrastructure expansions are currently undertaken to create new and comfortable capacities for access / egress to/from the airport. Investment costs are paid by the German public households as federal roads are in the hands of the federal states and a further improvement is presently not necessary.

Besides the road improvement railway has always been a hot topic for the airport in order to improve the connection of the airport by public modes of transport. The proposal of a magnetic levitation system connecting Hahn Airport to Frankfurt International Airport was discussed for some time but was found unprofitable and has therefore not been considered any further.³⁵ Due to the existence of a former railway line, which passes close to the airport, the proposal of a conventional rail service connecting the airport to the regional rail network stepped into focus and is currently in the process of implementation. The construction phase started in 2011 and the initial operation is planned for the year 2013. The concept requires the reactivation of approx. 60 km of tracks, which are single-tracked and currently inoperative. Furthermore, approx. 10 km of tracks need to be double-tracked as well as an airport station at Hahn needs to be built. In total approx. 95 Mio Euro of investment costs are necessary for the connection of Hahn airport to the German railway network.

A description of the geographic situation is given by Figure 6.527, which displays the proposal for the reactivation of the so called "Hunsrückbahn" from Langenlonsheim to Hahn Airport (bold orange line). It becomes obvious that close-by alternatives for access to railway do not exist. The reactivated tracks enable a direct connection to Bingen Central Station (red box) or even further to Mainz Central Station (blue box), which is directly connected to the German InterCity network of Deutsche Bahn AG. Information on the current planning suggest that every hour one train departs from Hahn to Mainz Central Station (via Bingen Central Station) and every second hour one further train to Bingen Central Station. Compared to the present situation with bus services frequencies will increase significantly from 10 to 20 (at least on the relationship between Hahn

³⁵ See <http://www.faz.net/artikel/C30535/transrapid-zwischen-frankfurt-und-hahn-abgefahren-30196568.html>

airport and Mainz Central Station). An ongoing debate is whether a direct link between the cities of Langenlonsheim and Gensingen-Horrweiler should be built in a later second construction phase. Such a link would allow a more direct connection between the airport and Mainz Central Station and to avoid a stop and directional control at Bingen Central Station (Bracht, 2007).



Figure 6.527: Regional railway network around Hahn airport (based on Rheinland-Pfalz-Takt³⁶)

Since a traction power system does not exist for the main part of the track, the trains would have to be operated with diesel locomotives. Unpredictable passenger volumes due to seasonal peaks and changing flight plans require a certain flexibility of capacities. This would most likely be solved by operating a different number of wagons or different wagon sizes rather than changing frequencies in order to avoid higher costs for additional personnel.

It is expected that the travel times will be around 90 minutes between Hahn airport and Mainz Central Station and around 125 minutes for the distance Hahn Airport – Mainz – Frankfurt

³⁶ See <http://www.der-takt.de/ueber-den-takt/takt-2015/streckenreaktivierung-2015/>

Central Station, which is rather long compared to the travel times by car (around 60 minutes to the centre of Mainz and 90 minutes to the centre of Frankfurt). According to the opposition party CDU in the Rhineland Palatinate state parliament, the construction of the link between Langenlonsheim and Gensingen-Horrweiler would reduce the travel time to Mainz and Frankfurt by 30 minutes, which would then be comparable to the travel times by car.³⁷

6.8.9.2 *Description of new business model*

6.8.9.2.1 Customer Segments (CS)

The customer segments relevant for the proposed business model are basically the same as for the current business model. The proposed rail connection might be an interesting alternative to the existing modes for all groups of passengers. It might further attract new passengers, whose demand could not be served by the existing modes of transport.

6.8.9.2.2 Value Proposition (VP)

The added value of the proposed business model lies in the introduction of a new railway connection to the airport. The new connection extends the offer of public transport services, which have so far been limited to bus and (to a very small extend) taxi and is supposed to improve the general accessibility, one of the main deficits of the airport.

Even though the proposed rail service is not expected to reduce neither travel times, nor ticket prices compared to other public transport modes, the provision of a rail service is expected to generate a number of benefits for different actors. Direct benefits can be expected for passengers, who can choose from a broader offer of public transport services. The additional services gives passengers more flexibility since the frequency of available public transport connections rises. Particularly with respect to egress from the airport, the waiting times of passengers can be reduced when incoming flights are delayed and bus services are currently not available.

The rail connection might be particularly interesting for passengers, who value comfort and reliability. Due to the small number of long distance bus services in Germany, there is no real experience with this mode. Rail transport is often regarded more comfortable and reliable than bus services, even though, from an objective point of view, the differences might be rather small. It can therefore be expected, that the introduction of a rail connection will serve a demand, which has so far not been satisfied by the existing transport offers.

³⁷ See <http://www.landtag.rlp.de/icc/Internet-DE/sub/9f9/9f940193-d1c3-e421-33e2-dc86d35f8f46,,,a aaaaaa-aaaa-aaaa-bbbb-000000000014&page=6&pagesize=10&startmon=11&startyear=2009.htm>

Rail is also interesting to customers from regions, which are so far not or only insufficiently served by bus. These customers are currently dependent on private cars, what makes the airport difficult to reach for people who do not dispose of a private car or who don't want to park their car at the airport for the time of their trip.

All these effects are expected to positively influence the number of passengers by the improvement of accessibility. Hahn Airport is potentially very interesting to an even greater number of passengers due to its low cost flights and the high number of attractive destinations, but has always had the problem of being located in a very rural area and therefore being difficult to reach for many potential customers.

Apart from bus operators and car rentals, which might experience competitive threats through the new rail services, all other actors benefit indirectly from the new rail service. The rising number of passengers and the general improvement of accessibility will raise the attractiveness of the airport also for airlines, retails, hotels and other business located at and around the airport.

6.8.9.2.3 Channels (CH)

The importance of the internet as a channel for rail tickets is growing but still not as high as for bus and air. Bus and air tickets at Hahn airport are sold almost exclusively via internet, railway operators still sell a considerable percentage of tickets via ticketing machines and service counters. It is not expected that integrated air/rail tickets will be offered since both Ryanair and Deutsche Bahn AG as the potential rail operator operate own ticketing systems, which are usually difficult to integrate.

6.8.9.2.4 Customer Relationships (CR)

Since Deutsche Bahn is already operating own customer programs (e.g. bahn.bonus, bahn.comfort, BahnCard), there will most likely be no special programs and CR measures for Hahn Airport customers. Regional commutation and season tickets offered by the transport association of the Rhine-Mosel region (VRM) will be relevant for passengers from the region. It can be expected that there will be considerable marketing measures by Deutsche Bahn and Hahn airport, particularly at the beginning, to promote the new service.

6.8.9.2.5 Revenue Streams (R\$)

Revenues of transport services are mainly generated from ticket sales. Therefore payment flows are directly from passengers to the different transport operators respectively services related to transport (such as parking facilities and car rentals). This also applies to the new rail service. Since the construction and operation of the new railway track is at least partially subsidised by the state, a new revenue stream in form of public finding will be added.

6.8.9.2.6 Key Resources (KR)

The key resource for the realisation of the proposal is the required infrastructure in form of a 60km single-tracked railway track, which needs to be reactivated. A ten kilometre section of the track needs to be extended to two tracks in order to allow the usage in both directions. Furthermore, a railway station needs to be build close by the airport. Further resources are the rolling stock and personnel, which are needed for the operation and maintenance of the service.

6.8.9.2.7 Key Activities (KA)

The Key Activities of Hahn Airport remain very similar to the current business model. In order to facilitate the transfer between modes, Hahn Airport will provide information also on the new rail service (e.g. via its website) and will cooperate with Deutsche Bahn and the federal states in the planning of the railway connection. The Key Activity of Deutsche Bahn will be the operation of the rail service and its marketing.

6.8.9.2.8 Key Partnerships (KP)

The most important partnership for the realisation of the proposed business model is the relation between the rail operator and the federal states as rail infrastructure investor and airport owner. The success of the project is therefore to a great extend dependent on the common planning and financing of the construction measures. the federal states will also decide on the possible construction of an additional link between the cities of Langenlonsheim and Gensingen-Horrweiler (see Figure 6.527), which is expected to reduce the travel times significantly compared to the estimations for the current proposal. The relation between the airport management and the railway operator becomes important at a later stage, and will mostly be relevant for the exchange of information such as time schedules and flight plans since Ryanair will most likely further cooperate mainly with the airport management.

6.8.9.2.9 Cost Structure (C\$)

Compared to the previous business model changes in the cost structure particularly appear for the federal states, which are partially financing the construction of the new railway line and the station. Since the federal states, as owners, are interested in the economic development of the airport, the new railway line is regarded an investment into the development of the airport and the region.

6.8.9.3 *Description of proposed service using the concept of Agents*

6.8.9.3.1 Agents

6.8.9.3.2 Objectives and Goals

Federal States of Rhineland-Palatinate and Hesse (Airport owners)

The federal states of Rhineland-Palatinate and Hesse as airport owners and investor of the new railway connection have the goal to improve the connectivity of the airport and to foster the development of the airport and the region. As such, the rail link is considered not only important for the accessibility of the airport but also to close the gap in the regional public transport system and improve the accessibility of the surrounding municipalities.

Airport operator (Frankfurt Hahn Inc.)

The goal of Frankfurt Hahn Inc. as airport operator is to maximise total profits and making the airport attractive to both business partners and passengers. With respect to the new railway connection, the goal is to attract more customers who are travelling by public transport.

Passengers

The main goal of passengers is to travel cheap and fast to and from the airport and to minimise transfer times. All trips should be as smooth as possible with a minimum effort for information search (the same as with the current business model).

Passenger airlines (Ryanair)

The main goal of the passenger airlines, which are mainly represented by the Irish low cost carrier Ryanair, is to maximise profits through the optimal utilization of capacities. This requires a high number of passengers (the same as with the current business model).

Bus operators (e.g. Bohr Bus Inc.)

The goal of bus operators is to maximise profits through serving high numbers of passengers. With respect to the new railway connection and the arising competition with rail operators, bus operators have the objective to maintain high market shares of passengers who travel by public modes of transport.

Car rentals (e.g. Europcar)

The goal of car rentals is to maximise profits through high sales. Car rentals are therefore, as all actors, interested in high passenger numbers. Car rentals profit from a limited offer of public transport services (the same as with the current business model).

6.8.9.3.3 Strategies

Federal states of Rhineland-Palatinate and Hesse

The federal states are able to improve the conditions for the economic development of the airport by investing in regional roads and by improvements of the technical and physical conditions at the airport. The existing infrastructural measures, which were focused mainly on the improvement of road connections, will be accompanied by the reconstruction and reactivation of an existing rail track. In the planning of the new rail connection the requirements of the airport are considered in order to close the gap in the current public transport chain and to improve the overall connectivity at and around the airport. The improved accessibility is expected to spur the economic development of the airport and make its operation more profitable. Besides the airport also the region is expected to profit from the new infrastructure. Therefore, the public funds, which are used for the project are regarded an investment into the economic regional development and the development of the airport in particular.

Airport operator (Frankfurt Hahn Inc.)

The strategy of the airport management changes insofar, as the new rail connection needs to be considered in the long term special planning at the airport and the management of the other existing transport offers at the site. Since both the airport and the rail infrastructure are at least partially financed by the federal states, the rail might be actively promoted. The airport management will though have to find a balance between the competing transport modes by providing both bus operators and rail operators a good business conditions.

Passengers

The passengers get another option to travel to and from the airport. Thus, their strategy changes insofar, as further offers need to be considered and further information on schedules and prices needs to be screened when planning the trip. Due to the increased flexibility, some passengers might also rely more on regular public transport services and might therefore gather less information before the trip.

Passenger airlines (mainly Ryanair)

The airline's strategies will not change with the new proposal.

Coach operators

Due to the introduction of the new rail connection, coach operators will face competition for public transport passengers. Coach operators might change their pricing structures and adjust

their offers in order to clearly differentiate their services from the rail service. Therefore it can be expected that bus operators will improve their services and market their offers more actively.

Car rentals (e.g. Europcar)

The car rental's strategies will not change significantly since in most cases different customer segments are addressed.

6.8.9.3.4 Interactions between agents

With the new proposal, the rail operator needs to be added to the matrix of actors (Figure 6.528). Due to the public investments in the rail infrastructure there exists a direct relationship between the rail operator and the federal states, who are also involved in the planning and tendering of transport services. Since rail services can be regarded a rather close substitute to bus services, rail operators will compete with bus operators for passengers. With respect to certain customer segments also competition with car rentals might exist. The relationships between Bus operators and the airport operator, respectively the passenger airlines, will be mainly characterised by cooperation since these actors provide complimentary services. Passengers will be the main customers of the rail operator.

Agents	Federal states	Airport operator	Passengers	Passenger airlines	Bus operators	Rail operator	Car rentals
Federal states		collaboration				cooperation	
Airport operator			provides services	cooperation, provides services	cooperation, provides services	cooperation	cooperation
Passengers				commercial	commercial	commercial	commercial
Passenger airlines					cooperation	cooperation	cooperation
Bus operators						competition	competition
Rail operator							(competition)
Car rentals							

Figure 6.528: Matrix of agents in the proposed business model

6.8.9.3.5 Graphical representation

Figure 6.529 displays the position, the rail operator has in the structure of agents within the new proposal. Due to the public planning and financing, there exists a direct relation with the federal states and thus an indirect relation with the airport. The relations can be described as cooperative since the rail operator needs to coordinate the planning and provision of services with public administrations and the airport management. Competition will arise between rail and services and to a lower extend between rail and car rentals. Passengers will in most cases interact face-to-face with the rail operator since tickets are usually sold directly at the station or on the trains.

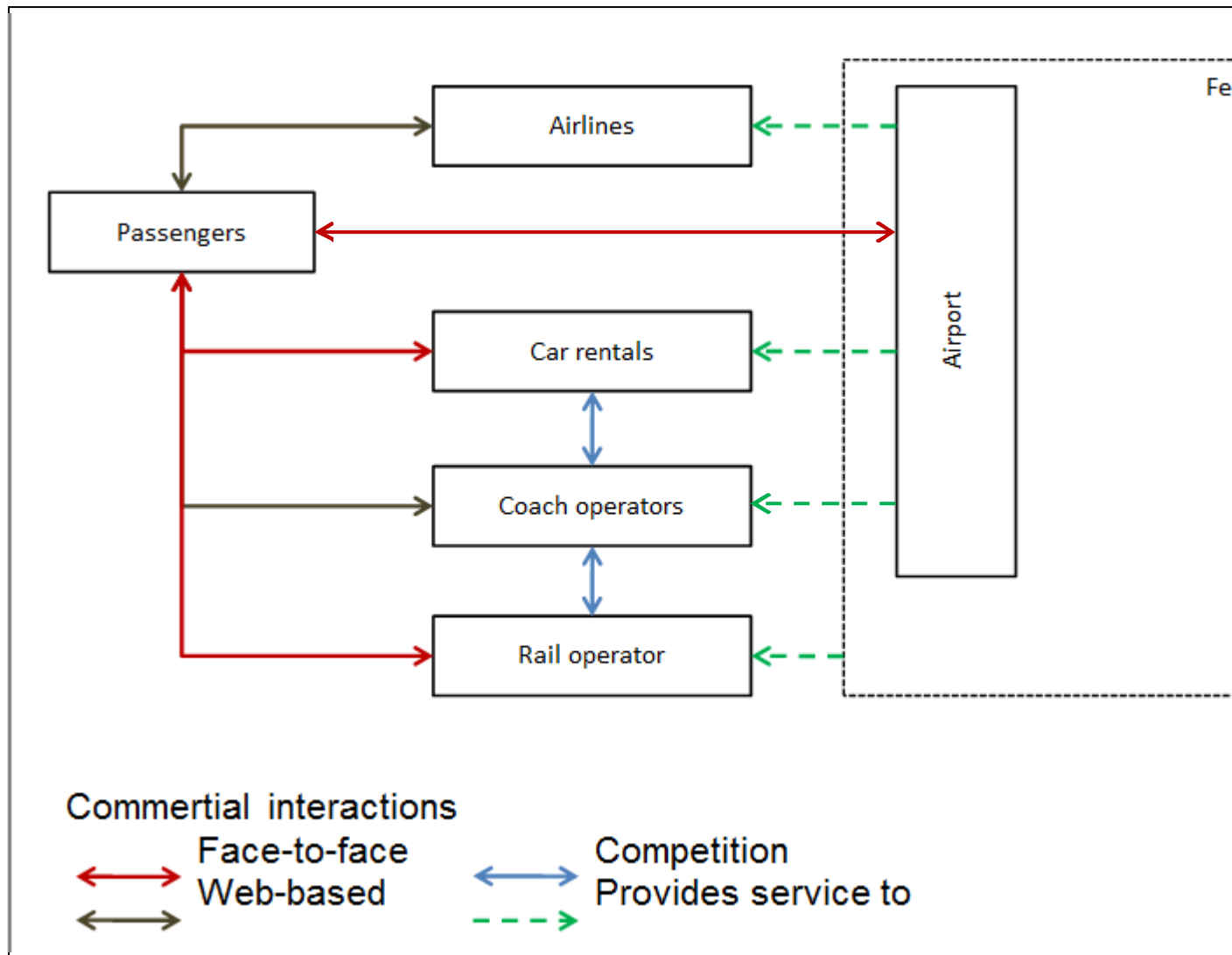


Figure 6.529: Structure of relations between agents in the proposed business model

6.8.9.4 Functions and Indicators to show enhancement

6.8.9.4.1 Functions of validation

The main element of change is represented by the new rail service, which is expected to improve the general accessibility of the airport. Thus, in order to evaluate the potential benefits of the proposal it has to be determined to what extent the new service will improve the general accessibility of the airport. The effect on accessibility is dependent on a number of factors such as travel times, waiting times, ticket prices, reliability, flexibility, mode changes, comfort and other preferential criteria. These factors are usually used to determine the generalized user costs in demand choice models (Ortúzar, 2011). In order to evaluate the accessibility improvement, the generalized costs of a user travelling to and from the airport are used to measure the effect of the proposal on accessibility. As such, rising generalized costs are expected

to reduce accessibility while sinking generalized costs improve accessibility. The function below describes the direction, in which the different factors are expected to affect general accessibility (A).

$$A = f(\text{travel times, waiting times, ticket prices, reliability, flexibility,} \\ \text{number of transfers between modes, comfort})$$

In this context travel times, waiting times, ticket prices and number of transfers between modes are perceived as *costs*, whereas reliability, flexibility and comfort are regarded as *benefits* to the user. In the next section, these factors will be described in more detail.

6.8.9.4.2 Indicators of validation

As described above, the concept of generalized user costs is used in order to approach the effects of the proposal on the general accessibility of Hahn airport. Hence, in order to validate the proposed business model, information on the different factors needs to be gathered. Below these factors and their indicators are described.

Travel time	Time spent on the trip from entering a means of transport at the origin of the trip until getting out of a means of transport at the destination of a trip.
Waiting time	Time spent at the origin of the trip, until the means of transport arrives.
Ticket price	Price paid for the entire trip from origin to destination.
Reliability	Probability that the transport service is on time, both at the origin and the destination of the trip.
Flexibility	Possibility to use different means of transport and/ or different routes on a trip as well as the possibility to reach further destinations within the transport network.
Mode changes	Number of transfers between different modes of transport between origin and destination of the trip.
Comfort	Perceived quality of transport, which might depend on different subjective factors such as noise, space, smoothness, personal assistance etc.

While factors such as travel time, waiting time, ticket price, mode changes and reliability can be measured in absolute terms and numbers, factors such as flexibility and comfort are difficult to quantify, as flexibility and comfort are subjective characteristics which are defined differently by different users.

6.8.9.4.3 Methods and tools

In order to analyse the effects of the new rail connection to Hahn airport on the overall improvement of accessibility, the different factors need to be compared before and after the implementation of the proposal. For the current situation, existing data from the customer survey and from publicly available sources is used. Since the proposed business model has not been implemented yet, indicators for the future situation need to be estimated or predictions from the project planning need to be used, where available. Based on these data, a descriptive analysis is made indicating the directions of changes of the individual indicators in order to estimate the overall effect of the proposal on the accessibility of Hahn airport.

6.8.9.5 *Demonstration and Evidence of Improvement*

In the following, the different factors are measured and assessed for the current and the proposed business model as far as a quantitative analysis is possible and the data is available.

Travel times and costs

Looking at the current situation, the two main transport modes bus and private car are to be analysed. Bus services are mainly operated as direct services without en-route stops between Hahn airport and their destinations. Therefore, a direct comparison between service level indicators is possible and summarized in Figure 6.530.

Differences in travel time are mainly caused by a higher average speed of cars compared to busses. Such differences occur especially on motorways which are used for a significant distance from the origins to Hahn airport (e.g. from Frankfurt, Hanau, Heidelberg, Karlsruhe, Köln)³⁸. In some cases (e.g. Heidelberg, Koblenz) the bus travel times appear to have included travel time premiums because of high congestion levels on the required motorways. In summary, for most of the provided routes travel times by bus are on an adequate level compared to travel times by car.

Travel costs are difficult to compare due to large differences in fuel costs and parking fees, which largely depend on the duration of parking. The high share of car users among customers of Hahn airport (see Figure 6.511) demonstrates that the private car has a competitive advantage compared to bus. This might be explained by the higher flexibility, which seems to be valued particularly high due to the rural location of the airport. It also indicates, that car is not perceived significantly more expensive than bus.

³⁸ The shuttle bus from Karlsruhe to Hahn airport runs via Heidelberg which explains the great difference between bus and car travel time.

Origin	Distance to HHN [km]	Travel time bus [min]	Price bus [Euro]	Travel time car [min]	Δ travel time [min]
Cochem	48	75	6,80	58	17(30%)
Frankfurt	125	105	13,00	83	22 (27%)
Hanau	147	105	10,00	97	8 (8%)
Heidelberg	155	135	20,00	92	43 (47%)
Idar-Oberstein	40	50	6,40	49	1 (2%)
Karlsruhe	196	235	28,00	117	118 (100%)
Koblenz	85	70	9,80	53	17 (32%)
Köln	180	135	16,00	116	19 (16%)
Luxemburg	110	110	27,00	90	20 (22%)
Mainz	89	70	12,00	62	8 (13%)
Simmern	23	38	6,80	23	15 (65%)

Figure 6.530: Level of service indicators to/from Hahn airport (road)³⁹

For the proposed business model the travel times and ticket prices of the rail connection need to be compared to the present situation. The bus mode is chosen as the point of reference due to its similarity in cost structure and availability. For the analysis, the connections of Hahn airport to Mainz Central Station and Frankfurt Central Station are chosen since these are the main relations of the rail service. Rail services to other destinations in the regional rail network are possible and will most likely account for a significant share of rail passengers but their assessment is difficult due to overlapping regional transport associations with special tariffs. The results of the comparison are summarized in Figure 6.531.

Origin	Travel time bus [min]	Travel time railway [min]	Δ travel time [min]	Price bus [Euro]	Price railway [Euro]	Δ price [Euro]
Frankfurt	105	130	+25 (24%)	13,00	23,00	+ 10 (77%)
Mainz	70	90	+20 (29%)	12,00	17,00	+5 (42%)

Figure 6.531: Level of service indicators to/from Hahn airport (road versus rail) ⁴⁰

The level of service indicators show that neither travel time nor ticket prices will lead to an improvement of accessibility compared to the present situation at Hahn airport because travel time as well as ticket prices of the rail service are higher than those of the existing bus services. Hence, in this respect also no improvement compared to private car can be reached. Effects for

³⁹ Distance to HHN is calculated based on the shortest paths from origin to the airport (no air line), travel time by bus and bus ticket prices are taken from the operators' webpages and the travel time car is taken from Google Maps.

⁴⁰ Price of railway estimated based on prices of comparable rail connections of Deutsche Bahn Regio.

the rest of the rail network are not assessed and might depend largely on the origins and destinations of trips. Therefore, the railway infrastructure investments need to be motivated and justified through other benefits, which are further explained below.

Waiting times

Information from the current planning suggest that every hour one train departs from Hahn to Mainz Central Station (via Bingen Central Station) and every second hour one further train to Bingen Central Station. At the moment there is an hourly bus service on the same route. Compared to the present situation with bus services only, frequencies will increase significantly from 10 to 20 connections per day on the relationship between Hahn airport and Mainz Central Station and from 10 to 25 on the relationship between Hahn airport and Bingen Central Station. Under the assumption that rail and bus services do not operate the same schedules, waiting times for public transport users on this important relation will drop significantly.

Flexibility

Public transport users are currently dependent on bus services. Taxi services exist but due to the long distances, high prices and limited capacities they cannot serve as a substitute. The introduction of the rail connection would create an additional option for public transport users. Passengers could choose from different modes, schedules and routes and would therefore gain flexibility. Thus, fewer planning would be necessary before the trip. Particularly when flights arriving at the airport are delayed, the flexibility to choose between different public transport modes can lead to a significant increase in passenger's utility. Furthermore, as several smaller cities along the track will be connected, the accessibility of the airport from the surrounding municipalities will be improved.

Reliability

So far it is planned that only the passenger trains to and from the airport are going to use the track. Therefore it can be expected that delays due a competing usage of the infrastructure is rather unlikely (bottlenecks might occur though at the intersection with the existing rail tracks and at the station in Bingen). Compared to buses, which have to use public roads that are often congested particularly around the city centres, the rail service might provide a considerable improvement of reliability.

Number of transfers between modes

Bus services usually only connect to the major cities. Passengers travelling to suburban areas or the surroundings have to change to regional buses, regional trains or metro. In any case it is

necessary to change the mode, which is often associated with difficulties due to un-harmonised schedules, non-integrated ticketing and in the case of German long distance buses peripheral locations of bus stations. One of the key outcomes of a recent study on the transport system of Santaigo de Chile conducted by Navarrete and Ortuzar (2010), shows that a rising number of mode changes significantly increases the user’s generalized costs of transportation. Passengers travelling by rail would face a lower number if mode changes since the rail network covers a much higher number of destinations than are accessible via bus.

Comfort

Although comfort is very difficult do grasp due to different needs, expectations and preferences of users, there are some comfort relevant aspects that tend to be rather beneficial to rail than bus. Trains allow passengers more freedom during the trip because it is possible to walk around, where on the bus passengers need to stay belted during the trip. Trains usually offer more space than buses, which is a significant benefit on trips longer than one hour. Trains usually provide some seats with tables which allow passengers to work or to eat comfortably during the trip.

Indicator	Improvement/ deterioration of the proposed BM compared to the current BM	Evaluation
Travel time	25-30% increase in travel time expected	-- --
Waiting time	Significant reduction possible due to additional public transport service (depending on schedules)	+
Ticket prices	Significantly higher ticket prices (depending on the route)	-- --
Flexibility	Additional services and destinations raise flexibility of public transport users	+
Reliability	High punctuality expected, trains are not competing with other users on the track	++
Number of transfers between modes	Less transfers between modes necessary when connecting to suburban or surrounding areas	++
Comfort	Trains provide more space and freedom than buses	+

Figure 6.532: Improvement analysis of the proposed business model

Figure 6.532 gives an overview of the different changes/ improvements between the two BM with respect to the above mentioned dimensions. As mentioned before, travel time and cost savings cannot be the argument for investments into the rail connection. However, there are a number of improvements, such as reduced waiting times, higher flexibility, higher reliability,

lower necessity to transfer between different modes and higher comfort, which stand in favour of the proposed rail service.

Though, it has to be noticed that the success of the new business model is to a large extent dependent on the development of the airport. Only if the trend of rising passenger numbers can be continued, the provision of additional transport services around the airport is reasonable.

6.8.9.6 Added value from the case study to the HERMES project

The case study on Frankfurt Hahn airport provides detailed insights to the issue of intermodal long-short distance interconnectivity from the perspective of a small, remotely located airport, which is mainly used by low cost passenger airlines. Despite its rural location the airport has seen rapidly rising passenger numbers since the beginning of operation in 2003, which was mainly due to growth of the low cost carrier market in recent years. While the case study has shown a high passenger satisfaction with most site specific characteristics such as waiting times, information and signposting, distances at the airport and provided air transport services, passenger satisfaction with regard to accessibility of the airport was comparatively low. Considering that only passengers who had already made a decision to travel via Hahn airport were questioned, it can be assumed that accessibility issues are also an important criterion for passengers who have so far decided not to travel via Hahn airport.

Due to the fact, that the airport has no rail connection, provided public transport services are currently limited to long-distance buses, which connect to the major cities in the area. The low availability of public transport services stands in contradiction to the distribution of customer segments. Although private cars account for the majority of transfers to/ from the airport, the large customer segments of young and price sensitive non-business customers do often not dispose of private cars. This certainly applies also to inbound passengers. Those customer segments are obliged to use long-distance buses. Car rentals do usually not provide an adequate substitute.

The case study describes the proposition to extend and reactivate an existing rail track, which links the airport to the German regional and long-distance rail network. Although no cost and time savings for passengers are expected there are a number of improvements, such as reduced waiting times, higher flexibility, higher reliability, lower necessity to transfer between different modes and higher comfort, which lead to improved accessibility of the airport via public transport modes. Another valuable contribution of the case study is the analysis of the interaction between the airport management, the land-bound transport operators and the federal states of Rhineland Palatinate and Hesse, which are both owner of the airport and

investor in the potential rail link and therefore play a key role in the planning, financing, realisation and management of the proposal.

6.9 Stockholm Arlanda International Airport, Sweden

6.9.1 Main features of the site

Stockholm-Arlanda Airport (IATA: ARN), is an international airport located in the Sigtuna Municipality of Sweden. Arlanda Airport is the largest airport in Sweden, and the third largest airport in the Nordic countries. The airport is located 37 km north of Stockholm. Stockholm-Arlanda airport is owned by the terminal manager Swedavia. Swedavia is a state-owned company that owns, operates and improves 13 airports in Sweden.

The figure below displays the area of Arlanda Airport. The map shows the four aviation terminals as well as interchanges for ground transport services such as bus, car and rail services at Arlanda Airport. In addition, the map shows estimated time for walking between different functions at Arlanda Airport.

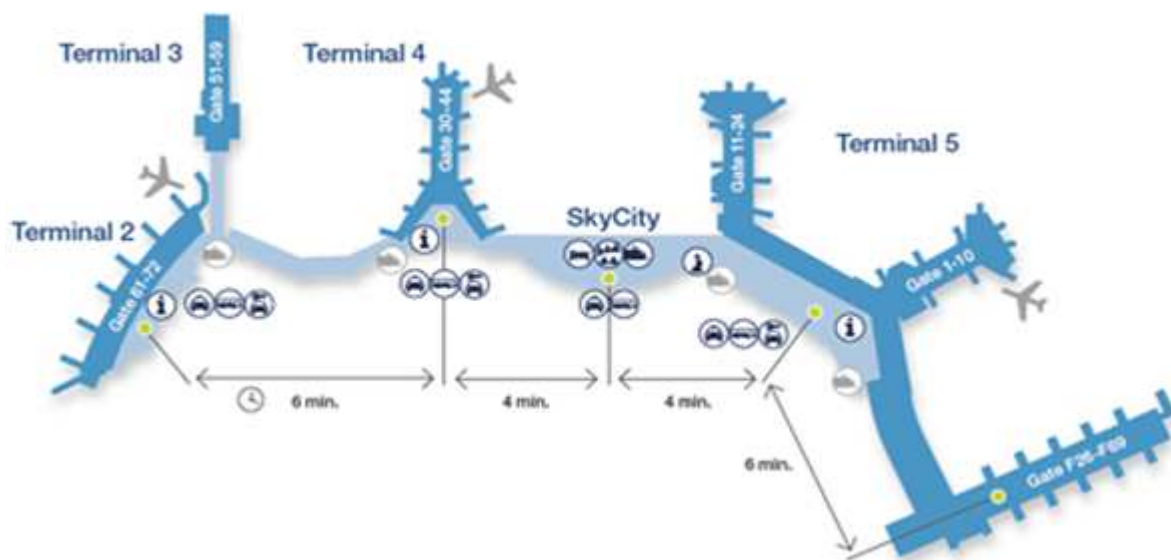


Figure 6.533: Map displaying terminals, gates and where different transport modes arrives/departures at Arlanda Airport

The Arlanda Airport has three runways for landing and take off and a total terminal area of 800 000 m². Arlanda Airport has four aviation terminals; the terminals 2 and 5 are used for international air-services while the terminals 3 and 4 are used for domestic air-services. Arlanda-Airport is also an important ground traffic hub with both long and short distance bus-, rail- and car-services. Stops for the ground transport modes are located outside each terminal. Change between ground transport services mode to air transport services are easily done due to the closeness of ground transport stops outside each aviation terminal.

There are different kinds of parking on Arlanda, partly parking spaces nearby the terminals, in p-houses and long-term parking. Furthermore, there are private parking companies just outside Arlanda with free bus transport to the terminals. There are ca 25 000 parking places on or nearby Arlanda.

The passenger can choose among two parking alternatives:

1. Near the terminals
2. Long-term parking

At Arlanda Airport passengers can park near the airport terminals as close to their gate as they can get. There are following near the terminals parking alternatives (see also the figure below):

- Multi-storey parking garages - are located close to all terminals (2, 3, 4 and 5).
- The SkyCity garage - this garage is climate-controlled and located in the middle of the airport, right next to Terminal 4 and 5.
- Outdoor parking - passenger has short walking distance to all the terminals. Maximum parking period is 90 days.
- Hourly parking - is for picking up and leaving passengers. This parking alternative is short-term only. There are five hourly parking areas, near all four terminals and SkyCity.



Figure 6.534 Parking alternatives near the terminals

There are several services for those who park at Arlanda Airport:

- Parking service employees - offers a patrol of the parking areas to solve any problems such as simple technical assistance, checking space availability and 24-hour service.
- Key service - passengers can hand in their car key and entry ticket for free safekeeping during their trip. Passengers can also get someone else to pick up their car.
- Car wash and servicing - In the SkyCity garage, an automotive workshop offers all types of car services such as car washing, reconditioning and tyre changes.

Long-term parking at Arlanda Airport is for those looking for the lowest price and passengers are parking a little further away (see Figure below). There are free transfer buses to the terminals. Passengers can choose between the long-term parking areas Arlanda Långtid Alfa and Arlanda Långtid Beta.

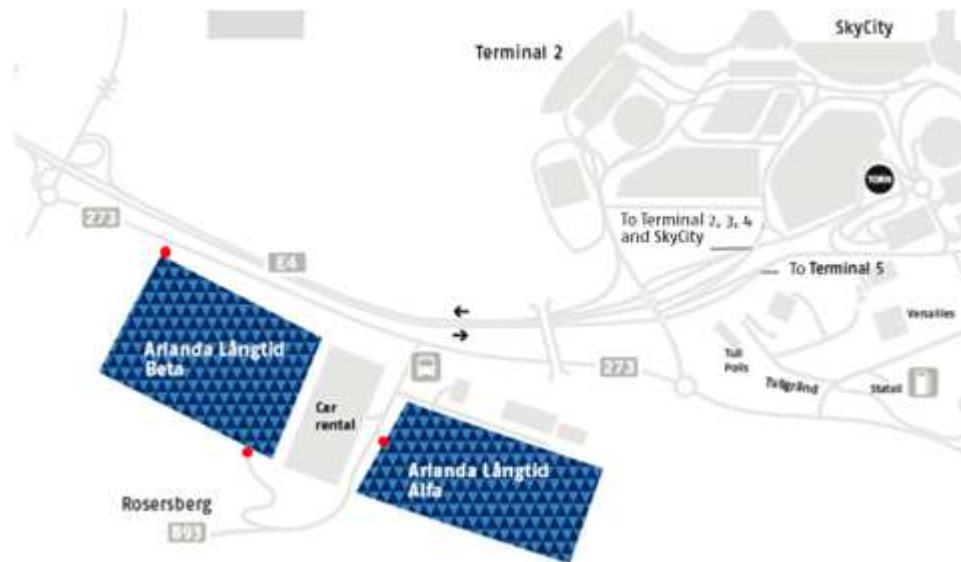


Figure 6.535 Long-term parking at Arlanda Airport

Arlanda Långtid Alfa is for those looking for the lowest price and not requiring as much service. There are free transfer buses to the terminals every 15 minutes. The parking area has surveillance cameras and passengers have access to round-the-clock customer service. Parking-related service is not included at Arlanda Långtid Alfa, but if passengers need start-up help, they can get a discount price from the nationwide motorist assistance organisation called the Assistance Corps (Assistancekåren).

Arlanda Långtid Beta is located some distance from the terminal area, but free transfer buses run often. Parking at Arlanda Långtid Beta includes extra services. Passengers can always get the following when they park:

- Bus service to the terminals, free of charge
- Surveillance cameras
- Round-the-clock customer service
- Parking-related service (start-up help, towing, lock assistance)
- Loading and unloading zone

There are specially designated parking spaces in every multi-storey parking garage for people with disabilities. Those passengers must contact Customer Service when entering and paying to verify their disabled parking permit. They pay the same price as for the long-term parking area Arlanda Långtid Beta, except in the SkyCity garage where they pay the regular price.

Hourly parking areas also have designated parking spaces for those with disabilities. There the maximum parking period is 3 hours and disabled parking permit must always be visible in the front windscreen. Disabled parking is free of charge.

At Arlanda Airport operate 84 airlines (this number includes 11 airlines for cargo and mail). Top 10 destinations are: Copenhagen, Oslo, London, Luleå (domestic), Helsinki, Frankfurt, Amsterdam, Umeå (domestic), Gothenburg (domestic) and Paris.

In overall, there are a large number of acting stakeholders at Arlanda Airport working for maintaining a high level and quality for service. Arlanda Airport has 52 shops and 41 restaurants, cafés and bars. There are also four hotels. Conference facilities inside the airport consist of 50 conference rooms for up to 700 people and 1500 m² exhibition space for up to 1 000 delegates. About 16,000 people employed by 250 companies work at Arlanda. According to their website the airport indirectly generates an additional:

- 1,000 jobs per million passengers.
- 2,000 jobs in the region for taxi drivers, day care staff et cetera.

This translates to more than 50,000 jobs in addition to those at the airport itself (see Arlanda's website).

6.9.1.1 *Environmental*

Airports are – according to the Swedish Environmental Code (1998:899) – businesses which are environment-damaging. In order to operate an airport the permit is required. Swedish Environment Court is the permit authority. Arlanda's permit is linked to various conditions.

One condition which is linked to this permit is “emissions limit value” (emission ceiling). Emission limit value is part of Arlanda's environmental permit and thereby Arlanda is the only airport in the world with an emissions limit value (342 495 tons per year). Emissions limit value implies emissions from:

1. Starting and landing aircraft
2. All ground traffic to and from Arlanda Airport
3. Internal traffic at Arlanda Airport
4. Heating of buildings

According to the Arlanda's permit the total emissions, including ground transportation, should not exceed 1990's level of carbon dioxide and nitrogen oxides emissions at the middle of year 2011.

Airport's permit is examined also by the Swedish Transport Agency. This agency formulates regulations, examines and grants permits, as well as assessing civil aviation with particular regard to safety and security.

Arlanda Airport has as priority to minimise the adverse environmental impact of its operation. Arlanda was as the first airport to meet the requirements for the highest level of a European programme that assesses the climate work of airports. On November 3, 2009, Arlanda Airport was accredited at the highest level, Level 3+.

ACI Europe (Airports Council International Europe represents over 400 airports in 46 European countries) and WSP Environmental are the organisations behind the assessment programme, called Airport Carbon Accreditation.

Airport Carbon Accreditation follows the Greenhouse Gas Protocol, an international standard developed by World Resources Institute (WRI). There are four levels in the programme at which airports are accredited. All requirements must be met to attain the highest level.

The highest level requires that the airport is entirely climate-neutral with respect to emissions from its own operations. When an airport has met the requirements for the highest level, it means that all the other levels on the scale have also been achieved (see Arlanda's website for more information about requirements).

In 2009, Arlanda also won the Swedish Energy Prize. Airport has reduced its total energy consumption by 25 per cent in four years.

On June 17 2010, Arlanda Airport and Turkey's Izmir Adnan Menderes International Airport were joint winners of the ACI Europe's environmental prize, the Eco-Innovation Award. The award is aimed at highlighting outstanding environmental performance and an innovative approach to environmental management.

6.9.1.2 Identification of the site

There are four concepts that are important for WP5: geographical coverage, transport mode, services per mode and interfaces and interconnections.

The case study of Arlanda Airport covers:

1. Long distance (for land >100 km) (for air >700 km) and short distance (for land <100 km)(for air <700 km)
2. Four different transport modes: air, rail, bus and car.
3. High capacity modes: air, rail, bus
4. Low capacity mode: car
5. Different transport services
 - a. Rail services: International rail service, interurban rail service, commuter train service
 - b. Bus services: International bus service, interurban bus service, urban bus service and shuttle service.
 - c. Car services: taxi, mobility service for passengers with disabilities, private car and rental car.

The case study of Arlanda-Airport covers also all three levels of interconnectivity which are addressed in the HERMES project.

- Interfaces between different modes: air-rail, air-road
- Interfaces between different type of service of the same mode:
- Interfaces between high capacity and low capacity mode: air vs taxi etc.

Arlanda Airport is an interchange of great importance with about 17 millions of passengers per year (16,96 million passengers). There are 12,94 million international passengers and 4,02 million domestic passengers. Travelling to and from Arlanda Airport is increasing continuously. The number of international passengers are increasing with 6,8 per cent and the number of domestic passengers with 1,8 per cent compared to 2009 (Facts and figures, 2010).

There are 166 direct passenger destinations with at least 10 departures in 2010 (Facts and figures, 2010). These destinations can be divided in following air services:

- 7 domestic lines for long distance air service
- 124 international lines for long distance air service
- 24 domestic lines for short distance air service
- 11 international lines for short distance air service

Besides air services there are rail and bus services. Rail services:

- 8 lines for long-distance rail services
- 2 lines for short-distance rail services

Bus services:

- 3 lines for long-distance bus services
- 9 lines for short-distance bus service

6.9.2 Method for data collection

6.9.2.1 Observations and collected material

6.9.2.1.1 Transport demand/Passenger flow

Statistical data has been collected from five stakeholders at Arlanda Airport: Swedavia, SJ, Arlanda Express, Taxiförbundet and Uppland lokaltrafik.

Swedavia (terminal manager) has delivered statistical data dealing with the number of air-passengers during the whole year 2010 but also divided per hour and month for 2010 as well as statistical data regarding peak and non peak period at Arlanda Airport. Furthermore, Swedavia has also delivered estimated data from their own passenger survey regarding last transport mode to Arlanda Airport. Statistical data regarding number of take offs during 2010 has been collected in Swedavia's report "Short facts 2010" which is available at Swedavia's web page.

SJ (transport operator) has delivered statistical data for the total number passengers arriving and departing at Arlanda Airport with SJ during 2010.

Arlanda Express (transport operator) statistical data regarding the total number of passengers with Arlanda express during 2010 has been collected from the company.

Taxiförbundet (The Swedish taxi federation) has delivered statistical data regarding the number of taxis that have arrived and/or departed with customer to/from Arlanda Airport. The total number of customers that have travelled with taxi to Arlanda Airport is an estimated number of 1,6 passengers' in each car, this is due to missing counting of passengers'.

Uppland lokaltrafik (UL) has delivered statistical data of the total number of passengers that has travelled with UL bus services and train services to and from Arlanda Airport.

Our ambition was to get an overview of the total passenger flow to and from Arlanda Airport but unfortunately we are missing statistical data from a number of stakeholders, among the missing stakeholders' statistical data is missing from the Public Transport Authority in the county of Stockholm. Furthermore, we are missing statistical data from a number of stakeholders that are providing commercial transport services to/from Arlanda Airport. This is due to their policy for company secrets.

6.9.2.1.2 Time data

Data about satisfaction with average service times (e.g how long time it takes: to walk between different function at the airport, to get different kind of services, to wait before departure with connecting transport mode) have been collected on-site by personal at Arlanda Airport.

Observations have been made by counting the people that were served in a given interval of time. The considered time interval was 20 minutes. The observation period was decided partly due to shortage of time at the site partly due to several observation objects. Total duration of observation period was 16 hours.

In addition, time data regarding the passengers average time at the airport before departure as well as their satisfaction/dissatisfaction regarding the same factor has been extracted from the customer survey.

6.9.2.1.3 Space data

Space data regarding the size of the Airport area has been collected from Arlanda Airport webpage. This data includes both data for the terminal area as well as data for the commercial area.

Space data has been collected at site by personal by counting available facilities and information channels on Arlanda Airport. The facilities and information channels has also been investigated in order to find out the level of accessibility for different groups of passengers such as disabled people, parents with pram and passengers with heavy luggage.

Data about passengers' satisfaction/dissatisfaction regarding factors dealing with space has also been extracted by the customer survey.

6.9.2.1.4 Information, Ticketing and Check-in Services data

Data about the number of information desks, ticketing and check-in counters were obtained by counting at site by personal. Data about information signs was collected by counting the signs and the sufficiency of the information signs was measured by observing the clarity and accessibility of the sign. Data about the passengers' satisfaction/dissatisfaction regarding information, ticketing and check-in services at Arlanda Airport has also been collected by the customer survey.

6.9.2.1.5 Customer survey

The customer survey was carried out between 12th and 17th April 2011. The questionnaire for Arlanda Airport was developed in accordance to the HERMES customer survey template. The questionnaire consisted of 20 questions.

The questionnaire was distributed on-site by seven staff with experience of implementing surveys. The staff was distributing the questionnaires at the terminals 2, 3, 4, 5 from 09.00 - 21.30. In total 993 questionnaire answers were gathered.

6.9.2.2 Stakeholder interviews

According to WP3 and WP4 there are four stakeholder groups: decision makers, terminal manager, transport operators and users' associations. The stakeholder survey at Arlanda Airport was conducted with three of four stakeholder groups: decision makers, terminal manager and transport operators. In Sweden there are no users' associations.

The stakeholders that have been interviewed were as following:

- Stakeholder 1-Managers' ("Swedavia, decision maker and terminal manager, state-owned company)
- Stakeholder 2-Marketing manager(Arlanda Express, (train) transport operator, private company)
- Stakeholder 3-Business manager ("SJ", (train) transport operator, state-owned company)
- Stakeholder 4-CEO ("Swebus Express", (bus) transport operator, private company)

The stakeholder interviews were conducted through telephone with one exception, the interview with Swedavias was conducted at Arlanda Airport. Following issues were addressed with all stakeholders:

- Activities at Arlanda Airport
- Business-model
- Interchange- Coordination between different transport modes, cooperations between stakeholders', ticketing , information systems, delays

6.9.3 Stakeholders at the site

Stakeholders at Arlanda Airport have been classified to the following stakeholder categories:

1. **Decision makers:** Trafikverket, Swedavia, SL and UL.
2. **Terminal manager:** Swedavia.
3. **Stat-owned Transport-Operators:** SAS Scandinavian Airlines and SJ.
4. **Private-owned Transport- Operators:** SAS Scandinavian Airlines, Arlanda Express, Tågkompaniet, Flygbussarna, Swebus Express AB, Y-buss, Air-Bus, Flygtaxi, car rental companies.
5. **Service Providers:** There are a large number of service providers.

6.9.3.1 Objectives and Goals

Trafikverket (The Swedish Transport Administration) is the new agency responsible for all modes of traffic: traffic on roads and railways, on the sea and in flight. This responsibility includes building, maintaining, operating and developing roads and railroad as well as to coordinate urban, regional and inter-regional railway traffic. Trafikverket is responsible also for keeping roads free from snow during winter and for delivering traffic information to companies as well to passengers. Trafikverket's vision is that all passengers will arrive to their final destination smooth, green and sage. Trafikverket has the role of being decision maker.

Swedavia, previously Lfv (the Swedish Civil Aviation Administration), is a Swedish self-financing state enterprise that is responsible for operating and developing 11 Swedish airports. These include Stockholm Arlanda Airport, Göteborg Landvetter Airport and Malmö Airport. Swedavia has about 2,600 employees (750 employees at Arlanda). Swedavias activities are funded entirely by revenues from the services and products provided to airports. The proceeds will partly come from the fees that airlines pay to use airports. Other revenue comes from airport shops, parking facilities, conference centres, restaurants and more. Shops and restaurants run by tenants and partners, while the car parks run in-house. Swedavia has both the role of Decision maker and terminal manager.

Climate work is Swedavia's area with the highest priority. The target is to achieve zero net emissions of carbon dioxide from heating and energy consumption by 2010 through its own measures.

SL is Public Transport Authority in Stockholm County. SL has the overall responsibility to provide a well developed, accessible and reliable public transport in Stockholm County. SL has role to conduct passenger traffic in competition with other companies. The year 2010 about 722 000 passengers/per one winter-day were travelling with SL. Company's activities, customer satisfaction and financial results were affected by harsh winter 2010-2011. According to SL's statistic there were 74 passengers per day who were satisfied with SL.

Here are two among other SL's targets:

1. Increase the number of customers and the number of satisfied customers
2. By 2025 all buses are biogas-fuelled buses

On 13 May, 2009 SL signed The United Nations Global Compact. This is a strategic policy initiative for businesses that are committed to aligning their operations and strategies with ten universally accepted principles in the areas of human rights, labour, environment and anti-corruption.

SL provides buses to Märsta station, Norrtälje, Rotebro and Östra Steninge. SL buses and commuter trains charge local traffic fares. Bus number 583 connects with the commuter train at Märsta station to Stockholm Central Station.

UL is Public Transport Authority in Uppland County. UL has the responsibility to coordinate timetables and prices and procure transport service. UL is also responsible to advertising the transport services and provide information. UL has 9 contractors (transport operators – rail, bus and taxi).

In 2010, travel has increased (relative to the previous year) by 2.9 per cent (about 312,000 trips). This means that about 12.3 million trips (about 12 million trips in 2009) were made by UL's buses and trains. UL's target is to design public transport so that it contributes to the sustainable travel and environment. UL provides buses to Enköping and Knutby.

SL and UL provide also short distance commuter train service between Upplands Väsby and Uppsala via Arlanda, with an onward connection to Tierp and Gävle, known as "Upptåget". Upptåget serves the airport every 30 minutes. The trip north to Uppsala takes 20 minutes. The trip south to Upplands-Väsby, where there is a connection to the Stockholm Transport (SL) commuter trains, takes eight minutes.

There are 84 airlines at Arlanda Airport (11 are cargo and mail airlines). SAS Scandinavian Airlines is the air transport operator with largest number of destination and is only company described here.

SAS Scandinavian Airlines: is an airline owned partly by the Scandinavian governments partly by private investors. The company offers primarily European air traffic from Stockholm, Oslo and Copenhagen. The company is also providing intercontinental air traffic in small scale.

- Long distance: international air service
- Long distance: interurban air service
- Short distance: interurban air service
- Short distance: international air service

SJ AB is a Swedish state owned company with responsibility to run profitable passenger traffic at railway in Sweden. SJ is operating rail services with intercity-, long distance- and night train with stop at Arlanda airport. During 2010 about a half a million of passengers were travelling to or from Arlanda Airport with SJ train. Also SJ was affected by unforeseen circumstances during 2010 (but also during 2009) giving consequences for the companies punctuality and reliability.

- Long distance: international rail services
- Long distance: interurban rail services
- Short-distance: interurban rail services

SJ provides every day 70 long-distance trains to cities in the Lake Mälaren Valley region around Stockholm and to Sweden's Dalarna and Norrland regions to the north. Examples of destinations in Sweden directly accessible by train from Arlanda Central Station are: Uppsala, Södertälje, Gävle, Hudiksvall, Sundsvall, Östersund, Åre, Borlänge, Falun, Leksand, Mora, Nyköping, Norrköping, Linköping.

Arlanda Express provides commuter train service (short distance) with a high service frequency between Stockholm Central and Arlanda airport at Arlandabanan. Arlandabanan is connecting Arlanda Airport with Stockholm. The railway was built by Arlanda Express for later handover to the Swedish state owned company, Arlandabanan Infrastructure. Arlanda Express has responsibility for the operation and maintenance of the railway and allowed due to their commitment to provide speed rail services at the railway and to receive the ticket revenue beside this revenue, Arlanda Express are allowed to collect fees from other transport operators providing services at Arlandabanan. The year 2010 about 2,9 millions of passengers' were travelling with Arlanda Express to or from Arlanda Airport. The activity was affected during 2010 partly by the harsh winter as well as the ash cloud that appeared over Europe's airspace and the pilot strike that hit the air traffic during the spring 2010. All together about 831 departures with Arlanda Express were canceled which affected the punctuality in a negative way. Beside the 2,9 millions of passengers who were travelling with Arlanda Express another one million passengers were travelling to Arlanda Airport at Arlandabanan with other rail service transport operators.

- Short distance-commuter train service

Tågkompaniet: provides on Saturdays and Sundays long-distance trains between Gävle and Stockholm via Arlanda. There are two departures in each direction. The trains also stop in Tierp and Uppsala.

Flygbussarna Airport Coaches: There are two lines: between Stockholm City Centre and Arlanda Airport and between Uppsala and Arlanda. Tickets can be purchased at the Arlanda Visitor Center in Terminal 5 or at information desks in Terminals 2 and 4.

On weekdays there are about 100 departures on the airport coaches (Flygbussarna) between Central Stockholm and Arlanda Airport. During peak traffic, the coaches depart at least every ten minutes. The airport coaches to and from Stockholm have machines at the terminals and at bus stops where a passenger can buy tickets. The Flygbussarna Airport Coaches offer e-tickets and text message (SMS) tickets.

One service which provides by Flygbussarna is **SuperShuttle**. This service is aimed for passengers in northern and western Stockholm. SuperShuttle is a minibus that takes passengers to and from Arlanda Airport. Passengers can book in advance by telephone or on-line and share a ride with other passengers. Payment is made right when passenger book or at the end of journey. Passengers are picked up at the address they provide and dropped off at the terminal.

Swebus Express AB: runs scheduled commercial interurban bus services and international bus services between larger cities in Sweden as well as to and from Oslo and Copenhagen. Swebus Express runs mainly long-distance bus services but also some short distance bus services as their bus line with high frequency between Stockholm and Arlanda which started in 2010.

- Long distance- interurban bus service
- Long distance- international bus service
- Short distance- shuttle service
- Short distance-interurban bus service

Swebus runs a route between Arlanda Airport and the City Terminal bus station in Stockholm. The route offers more than 40 daily departures. Swebus also has ticket machines in the terminals and at the bus stops. Passengers can pay on board the bus but only by credit card or with an e-ticket or text message (SMS) ticket. Swebus provides buses to Västerås, Enköping and Örebro

Airport Coaches – Uppsala: The public transport company Upplands Lokaltrafik (UL) also offers airport coach service between Uppsala and Arlanda on route number 801. During peak traffic, the buses depart every 20 minutes. Passengers can buy tickets by credit card, and in ticket machines in Terminal 2, 4 and 5.

Y-buss provides buses to Umeå och Gävle. Passenger can buy the ticket in advance from their website (Swedish only). Y-buss to Umeå departs only from Terminal 5, and Y-buss to Gävle departs from all terminals.

Air-Bus provides daily coach service between Arlanda and Karlstad, via Örebro, plus to and from Västerås, Köping, Arboga, Örebro, Karlskoga och Kristineham.

The Airport taxi (Flygtaxi): provide a service to book a taxi at the same time as passenger book his flight tickets. Flygtaxi conveys preordered taxi missions to local taxi companies. Taxis are available directly outside all terminals at Arlanda Airport. Most taxi companies offer a fixed price. 74 percent of all taxis at Arlanda are ecotaxis. Swedavia’s goal is that all taxis at the airport will be ecotaxis by June 2011.

Rental car: Five car rental companies at the Airport are located next to the airport's long-term parking areas Arlanda Långtid Alfa and Arlanda Långtid Beta. It is easy to get to the companies and back to the terminals on free transfer buses.

All transport operators have as goal to increase the number of passengers. The table below shows transport services offered by transport operators at Arlanda Airport.

Transport services Transport operator	Air services		Rail services		Bus services		Car services	
	long-distance	short-distance	long-distance	short-distance	long-distance	short-distance	long-distance	short-distance
SAS	x	x						
83 other airlines	x	x						
SL				x		x		
UL				x		x		x
SJ AB			x	x				
Arlanda Express				x				
Tågkompaniet			x	x				
Swebus Express					x	x		
Airport Coaches						x		
Flygbussarna Airport Coaches						x		
Y-buss					x	x		
Air-Bus					x	x		
Different Taxi companies								x
5 car rental companies				x			x	x

Figure 6.536: Transport services offered by transport operators at Arlanda Airport

All bus and rail transport operators to and from Arlanda have two common targets: to be environmental-friendly and to increase the number of passengers.

Service Providers: Arlanda Airport has 52 shops and 41 restaurants, cafés and bars. There are also four hotels. Conference facilities inside the airport consist of 50 conference rooms for up to 700 people and 1500 m² exhibition space for up to 1 000 delegates. About 16,000 people employed by 250 companies work at Arlanda.

6.9.3.2 Strategies

Swedavia

Arlanda Airport has emissions limit value which implies emissions from:

- Starting and landing aircraft
- Heating of buildings
- Internal traffic at Arlanda Airport
- All ground traffic to and from Arlanda Airport

Starting and landing aircraft: Swedavia has the strategy called “Green approaches”. A green approach means that an aircraft descends continuously from its cruising altitude to the runway. By descending continuously, the aircraft requires almost no engine thrust. Thereby, the aircraft is saving fuel and reducing emissions. Green approaches also mean that noise will decrease somewhat in the proximity of the airport because the aircraft does not need to produce engine thrust at lower altitudes. Experiments using green approach to Arlanda are being carried out jointly by Swedavia and SAS. Today they are executed by some 60 different airlines. According to Arlanda’s website it has only been possible to carry out green approaches during off-peak traffic periods, since it is not possible to mix green and conventional approaches during peak traffic.

Heating of buildings: Airport’s energy consumption includes space heating, electricity and cooling. Swedavia has one department (Stockholm Arlanda Energy) responsible for the airport’s energy use. This department’s activities include purchasing and producing energy which is then distributed to the companies and organizations at the airports. Department purchases “green electricity certificates” and these certificates guarantee electricity production from exclusively renewable sources (wind, solar, hydropower and biofuels). Most buildings at Swedavia’s airports are warmed up today with district heating based on biofuel. Swedavia’s net carbon dioxide emissions from space heating of its own buildings at Arlanda Airport are regarded as being zero.

Swedavia also wants other companies’ buildings at Arlanda to use renewable energy. Net carbon dioxide emissions from space heating of other buildings at the airport are already low, emissions

from space heating in the entire airport are 95 per cent lower today than in 1990. The target is that all space heating of buildings at the airport shall be biofuel-based.

Internal traffic at Arlanda Airport: Arlanda was the first airport in the world to buy biogas-fuelled buses for passenger service inside the airport area, and today all new buses bought by Swedavia run on renewable sources of energy. The target is for all of the airport's own buses to operate on such energy sources by 2012.

All ground traffic to and from Arlanda Airport: For those who choose to ride in a taxi, there is already a separate ecotaxi queue outside the airport terminals, in front of the other taxis. By 2007 more than 30 percent of taxis serving Arlanda were environmentally clean vehicles. The airport's strategy is that all taxis that serve Arlanda shall be ecotaxis. The airport also gives preferential treatment to clean vehicles, for example by allowing them to park in the best spaces at Arlanda.

Since October 2006, aviation kerosene is transported by railway from Gävle to a reloading station and is then pumped to the airport's fuel depot in a pipeline.

Other activities: Swedavia buys certificates from projects in developing countries. These certificates guarantee that an equivalent emission reduction will occur through these projects and within the framework of the United Nations' efforts to combat climate change.

Bus and rail transport operators

As we said earlier, all bus and rail transport operators to and from Arlanda have as a targets to be environmental-friendly and to increase the number of passengers. Bus operators' strategy is to use new buses based on biogas. Train operators' strategy is unclear.

When it comes to strategies which should be used to fulfil target "increased number of passengers" there are two common strategies: punctuality and safety.

6.9.3.3 Interactions between agents

The table below describes the nature of the interactions between some agents at Arlanda Airport.

Agents	Swedavia	SAS	84 different air companies	Arlanda Express	Other rail companies	Swebus Express	Other bus companies
Swedavia	Terminal Manager	Contract and services	Contract and services	Contract and services	Contract and services	Contract and services	Contract and services
SAS	Services and Incomes	Air Transport Operator	Competitor	Partner	Partner	Partner	Partner
84 different air companies	Services and Incomes	Competitor	Air Transport Operators	Partner	Partner	Partner	Partner
Arlanda Express	Services and Incomes	Partner	Partner	Rail Transport Operator	Competitor	Competitor	Competitor
Other rail companies	Services and Incomes	Partner	Partner	Competitor	Rail Transport Operators	Competitor	Competitor
Swebus Express	Services and Incomes	Partner	Partner	Competitor	Competitor	Bus Transport Operator	Competitor
Other bus companies	Services and Incomes	Partner	Partner	Competitor	Competitor	Competitor	Bus Transport Operator
Flygtaxi	Services and Incomes	Partner	Partner	Competitor	Competitor	Competitor	Competitor
Other taxi companies	Services and Incomes	Partner	Partner	Competitor	Competitor	Competitor	Competitor
Rent-a-car companies	Services and Incomes	Partner	Partner	Competitor	Competitor	Competitor	Competitor

Figure 6.537: Interaction between agents at Arlanda Airport

6.9.4 Current short-long interconnectivity problems/opportunities

Carbon dioxide and nitrogen oxide are gases that contribute to global warming and thereby to a rise of the global temperature. Emissions of these two gases are directly related to fuel consumption. According to Stern report (Stern N, The Economics of Climate Change – the Stern Review, 2006 available at www.hm-treasury.gov.uk) transport and land use accounts for 32 percent of emissions.

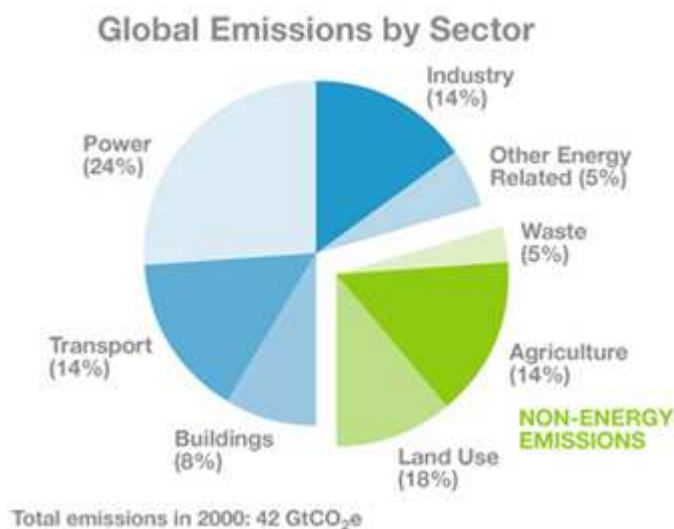


Figure 6.538: Global Emissions by Sector (Stern report, 2006)

In Sweden as a whole, road traffic accounts for about 38 per cent of carbon dioxide emissions and 40 per cent of nitrogen oxide emissions. Air traffic accounts for about 4.8 per cent of carbon dioxide emissions and 2 per cent of nitrogen dioxide emissions.

Globally, carbon dioxide from aviation accounts for about 2 per cent of total emissions. Other sources of emissions are the rest of the transport sector, combustion, industrial processes etc. The impact of air traffic on the climate may be larger than its share of carbon dioxide emissions, since these emissions occur at high altitude (Arlanda Airport's website, October 2011).

Arlanda Airport is the only airport in the world with the emission limit value. This limit implies emissions from:

1. Starting and landing aircraft
2. All ground traffic to and from Arlanda Airport
3. Internal traffic at Arlanda Airport (interna fordonstrafiken)
4. Heating of buildings (uppvärmning av byggnader).

Emissions limit value is a part of Arlanda's environmental permission. The Swedish government has decided that the total emissions, including ground transportation, on Arlanda should not exceed 1990's level of carbon dioxide and nitrogen oxides emissions at the middle of year 2011. Arlanda's emissions limit value is 342 495 tons per year.

		Ton CO2	Share	Ton CO2		Total
Passengers	Own car (parking)	25 917	14 %			
	Travel by car (to pick-up and leave someone at the Arlanda)	67 027	37 %			
	Rent-a-car	971	1 %			
	Taxi	16 776	9 %			
	Bus	3 840	2 %			
	Arlanda Express	58	0 %			
	Train	2 856	1 %	117 444	65%	34%
Staff at Arlanda Airport	Own car	24 052	13 %			
	Bus	887	0 %			
	Train	13	0 %	24 952	14%	7%
Fuel	Transportation of fuel	51	0 %	51	0%	0 %
Other types of transportation	Freight , by car	8 413	5 %			
	Freight , by truck	6 858	4 %			
	Material for construction	1 336	1 %			
	Service-transport , by car	6 950	4 %			
	Other freight , by truck	15 956	9 %	39 513	22 %	11 %
Sum	Ground transportation	181 960	100 %	181 960	100%	53 %
Total CO2 emission				345 491		100 %
Arlanda's emissions limit				342 495		

Figure 6.539 Current (2007) emission levels of CO2 divided into sources (WSP, 2008)

Unfortunately, Arlanda Airport exceeded emissions limit value in 2007 by 3 000 tons per year (see Table above). This emissions limit value prevents the growth of international air-lines.

The major challenge for Arlanda Airport is to reduce emissions from ground transport to and from Arlanda. Emissions from ground transport account for 53 percent (see Table above) of the carbon dioxide emissions. About 45 per cent of passengers take public transport to the airport,

which is an internationally high figure. But to enable Arlanda Airport to achieve its target there are one important question: How to persuade more people to use public transport?

According to Arlanda's website all transport market players agreed (September 23, 2008) on the most important measures, grouped under three main headings:

1. **Improve the capacity of the railway network** – among the other things by improving the availability of trains, coordinating timetables and improving the accessibility of the Arlanda Link (the railway used by the Arlanda Express).
2. **Improve accessibility by train and bus** – among other things through better public transport connections from municipalities north-east of Stockholm and direct long-distance train connection from hubs in the Stockholm-Lake Mälaren region.
3. **Reduce the environmental impact of road transport to Arlanda** – among other things through incentives to motorists to environmentally adapt their car trip, streamlining of corporate transport services and setting a goal of 100 per cent ecotaxis.

6.9.5 Current value proposition

Arlanda Airport has an environmental profile. There is an agreement between transport market players to persuade people to use public transport to and from the airport (see above). For those who choose to ride in a taxi, there is already a separate eco-taxi queue outside the airport terminals, in front of the other taxis. The airport's target is that all taxis that serve Arlanda Airport shall be eco-taxis by 2011. The airport also gives preferential treatment to "clean" cars, for example by allowing them to park as close as possible to the terminal for passengers.

But there is still a lot of room for improvement when it comes to public transport. Today, driving a car is the only alternative from a number of areas.

Our current value proposition it to find solutions to decrease usage of cars to and from Arlanda. Target groups are passengers and employees.

6.9.6 Description of current business model

The description of current business model is gathered by reading stakeholders annual reports and collecting information available at stakeholders' websites. Current business model is complemented and confirmed by stakeholder interviews.

Current business model for Arlanda Airport is described according to Osterwalder (2004). There are nine building blocks Customer Segments (CS), Value Propositions (VP), Channels (CH), Customer Relationships (CR), Revenue Streams (R\$), Key Resources (KR), Key Activities (KA), Key Partnerships (KP) and Cost Structure (C\$).

6.9.6.1 Customer Segments (CS)

The number of passengers at Arlanda Airport varies quite a lot depending on weekday, see table below.

Weekday	Average number of passengers/weekday
Monday	49,643
Tuesday	47,030
Wednesday	48,950
Thursday	51,204
Friday	50,712
Saturday	33,131
Sunday	47,066

Figure 6.540: Number of passengers per weekday at Arlanda Airport (Source: Swedavia short facts 2010).

During the entire 2010, about 16, 9 millions of passengers were travelling to and from Arlanda Airport with different air services, of these passengers 12, 9 millions were travelling international while 4 millions travelled within Sweden.

Stakeholder	Passenger flow <u>to and from</u> Arlanda Airport
SJ	500 293
Arlanda Express	2 900 000
UL	754 000
Taxi	3 247 817

Figure6.541: Transport flow to Arlanda Airport

The table above shows passenger statistics from four main transport operators at Arlanda Airport.

Last transport mode to Arlanda Airport	Passenger flow <u>to</u> Arlanda	Share
Bus	1 267 160	15 %
Car	3 588 917	43 %
Conference at ARN	25 010	0,3 %
Flight	1 260 563	15 %
Hotel at ARN	301 138	15 %
Train	1 795 543	22 %
Other	12 935	0,2 %
Total	8 251 266	

Figure6.542: Transport flow to Arlanda Airport

Data for the passengers' last transport mode (see table above) is based on a travel behaviour survey from 2010 (Markör, 2010) and weighted after statistics over the actual number of passengers at Arlanda Airport.

According to Arlanda's website their passengers (generally) have following profile:

- Mobile
- Urban residents

- Large share of decision makers (at Stockholm Arlanda Airport alone, 8,192,000 pass through each year)
- Active lifestyle
- Early adopters
- 56 per cent men / 44 per cent women

Arlanda's business passengers have following profile:

- Urban residents
- Person aged around 35
- Well-educated
- Well-paid
- Travelling on business
- Leisure time interests: golf, sailing, skiing, art
- 70 per cent men / 30 per cent women

Our customer survey showed that the age group 36-55 years were the major customers (41,4 %) at Arlanda Airport. See table below for a detailed age distribution among the passengers.

Age	Share
15-20	7%
21-35	24%
36-55	41,4%
56-64	16,1%
65 >	11,5%

Figure6.543: Age distribution Arlanda Airport (Source Customer survey, 2011)

The customer survey showed that the travel purpose was to 34 % business related while 64 % of the passenger travelled with private purpose and 2 % travelled for studies. What class do passengers choose to travel?

Regarding the air services at Arlanda Airport, 89 percent are travelling in economy class, 2 percent are travelling in first class and 10 percent are travelling in charter class (Markör, 2010). Furthermore, the transport operator SJ are also offering two different travel classes, first and second class, but unfortunately there is no number on how many passengers travelling in each class.

6.9.6.2 Value Proposition (VP)

The following questions are in detailed answered in sections 2.2 and 2.3:

- What kind of transport services does the company offer

- What are the different services provided by the company

Arlanda airport is an international airport and the most important airport in Sweden. Arlanda airport has a large geographical coverage in Sweden as well as in Europe and worldwide. From Arlanda airport it's possible to travel to many destinations with direct flights and thereby avoiding change of airplane.

According to the stakeholder interviews, the airport manager has the role to see that all different businesses at the airport operate as smooth and easy as possible. This means that they primarily have to see to the overall picture and mainly focus on the needs of the travelers.

In overall, passengers seem to be satisfied with services at Arlanda Airport. A survey made by the terminal manager shows that 69 percent of the passengers are satisfied with the interchange. This shows that the reliability is quite good, furthermore the terminal manager is constantly working for improving each individuals travel experience and make the passenger feel satisfied and secure. In case of delays and canceled departures passengers are rebooked or get their money back. Some transport operators for instance SAS and SJ has an "arrival in time guarantee".

Several transport operators in particular air service providers are offering different travel classes, also SJ (state owned transport operator) is offering different travel classes (first and second class) where passengers in first class are travelling more comfortable than passengers in second class.

Different transport operators have in general different ticket-systems and cashless travelling in public transport is common nowadays. It is possible to prebook a "resplus" (Resplus is a cooperation between almost every traffic company in Sweden) ticket including different transport operators as well as different transport modes. Benefits with using a "resplus" ticket is that the whole trip becomes more seamless with short walking distances between transport modes as well as short waiting time.

When it comes to passengers with reduced mobility, they are allowed to travel with all offered transport services at Arlanda Airport. Disable people and people with reduced mobility should be protected from discriminations and have thus right to get assistance to get to and from the air-plane.

From December 2010, it will be easier for a person with disabilities to get to / from and between trains. A new European Regulation from December 2010 means that a person with disabilities is entitled to an escort throughout the trip. Those who are in need of escort can order that when they buy the ticket, even if the trip is provided by different companies. The regulation covers

flights to and from EU airports. In Sweden, the Transportstyrelsen, The Swedish Transport Agency, are responsible for regulation, which means that the rules apply to all Swedish airports.

Regarding the punctuality in overall there is a good reliability as well as a good punctuality at Arlanda Airport. However during the last two harsh winters there have been problems with canceled departures or delays. This has in some cases resulted in a lower reliability as a consequence.

6.9.6.3 Channels (CH)

The information about Arlanda Airport is rich both before and during the visit at Arlanda Airport. The passenger can gather information at Arlanda website before the trip has started as well as during the trip. The main channel for traffic and service at Arlanda Airport is the Arlanda website where information about all different kind of services at site is available. This website distributes information about arrivals and departures, connections to other transport modes and information about other services offered at the airport such as shops and eateries. Maps are also available at the website which simplifies the upcoming or current trip. This information can also be collected by using cell phones or smart phones.

All transport operators are using advertisement in order to attract customers for their services. The transport operators are also using websites for spreading information about their services. When it comes to pre-information regarding prices and timetables for different transport services, it is in general available at the different transport operators' websites or at "Resplus" web site. For most of the transport operators' websites are the most relevant information channel.

For passenger at site at Arlanda Airport there are a number of desks providing both information and ticket sell. However there are no common ticket sell for transport services besides air services, this is also confirmed by the stakeholder interviews. The ticket situation for the transport modes are the same at the airport as for any other travel center and the travelers focus are mainly on the air services. The stakeholders don't have a problem with this situation and are satisfied with the existing channels for sale of tickets.

Tickets can also be bought by travel agencies, online (distributed to the customers in several different ways as e-mail, sms, collected at the agencies etc) In case of delays or canceled trips several transport operators compensates shortcomings.

Information is also mediated by a large number of signs at site showing the way at the airport. There are also large signs for upcoming arrivals and departures to/from Arlanda Airport. According to the stakeholder interviews are information, signs and displays areas that can be

improved. There is an information policy at the airport that has been decided by the airport manager and this policy is accepted by the stakeholders that operate at the airport but they think that this issue could be improved. Everybody wants to advance their business and to get visible signs but they also understand the purpose for this policy.

6.9.6.4 *Customer Relationships (CR)*

The customer gets usually in contact with the Arlanda Airport first when it's time for travel. Airline tickets are usually booked in advance by agencies or through websites. If the customer wants to travel further from Arlanda with different bus services, train services or car services tickets can usually be bought on board or at the airport by machines or by staff in ticket shops.

There are several information desks at Arlanda Airport where different transport operators:

- Sell tickets
- Give a detailed face-to-face information
- Help passengers with their issues at Arlanda Airport.

It is also possible for passengers to take contact with responsible transport operator's customer service by phone via their website or mail.

Regarding fidelity programs, different transport services are offering different fidelity programs, frequent travelers are often offered a discount or a bonus card permitting certain benefits such as free access to lounges at the airport or free news paper and so on.

For the ground transports services it is often possible to buy different kind of tickets, such as one-way ticket or different tickets cards valid for a given number of trips or valid for a given period which is often highly discounted. Some private transport operators are offering different sell-channels and are discounting prepaid tickets. This is due to a desire of less ticket handling at the transport mode.

6.9.6.5 *Revenue Streams (R\$)*

The terminal manager collects fees from the transport operators' use of the infrastructure (en route, passenger and take-off charges). Other important revenues come from non-aviation revenues such as parking fees, commercial site rentals, office rentals, advertising spaces and commercial services. Stakeholders who want to operate at the interchange have to accept both conditions and fees set up by the terminal manager.

The transport operators are depended on ticket sale with exception from Arlanda Express as to its ownership of the railway infrastructure beyond their ticketing sale also collect fees for other transport operators' use of the railway infrastructure. Furthermore, other companies' revenue sources are based by selling different services to travellers.

There are no common ticketing schemes. Different transport operators has different ticketing scheme and are also varying depending on chosen destination. Some transport operators of shuttle service offer up to four children to travel for free when they travel with one full paying adult.

The stakeholders interviewed at Arlanda airport have the same purpose and objectives for their operations mainly because they don't receive state aid. This means that the focus is on revenue management and to approach the largest travel group and to adjust the business to the travelers' wishes and needs.

6.9.6.6 *Key Resources (KR)*

The terminal manager owns the land as well as the airport infrastructure including terminals and runways, vehicles and equipments. There are four flight terminals and three runways at Arlanda Airport. There is also one underground train station below the airport which is owned by Arlanda Express. The owner of the train station is also owner of the railway tracks and the platforms. Other key resources are vehicles used for providing transport services such as airplanes, buses, trains, taxis and rental cars.

About 16 000 people are working at Arlanda airport at different positions, among other following human resources can be found at the airport: Drivers (bus drivers, taxi drivers, train drivers), Pilots, Sellers, Restaurant staff, Cleaners, Guards, Ushers, Travel leaders, Escort and so on.

6.9.6.7 *Key Activities (KA)*

The key activities is mainly performing long and short transport services both air services (passenger and freight services, however freight is out of scope in this study) and other transport services such as rail service, bus services and car services. The terminal manager's key activity is to provide aviation services for transport operators with activities at the airport, for instance security control and baggage handling. Another important activity for the terminal manager is to coordinate transport operators as well as different transport services.

The terminal manager rent out premises for other activities in order to create a higher value for the traveler by offering different services. Among others, following activities are presented at Arlanda Airport (beside transport services):

- Banking services
- Shops
- Eateries
- Hotels and conference facilities
- Pharmacy
- Courier service

- Dog hotel
- Lounges
- Dentist
- Doctor
- Hairdresser

The listed activities above are complements for the transport services offered at Arlanda Airport in order to fulfill the passengers' requirements and needs.

6.9.6.8 Key Partnerships (KP)

Arlanda Airport has one owner and managing stakeholder that decides the conditions at the airport (Swedavia). This means that stakeholders that want to operate at the airport have to accept the conditions that have been set up by this stakeholder and in some cases pay a fee regarding the traffic that goes to or from Arlanda.

The airport manager operates for the purpose to be a climate-neutral company. An important work is identifying the company's emission of green house gases and implementing measures to reduce this. A number of concrete measures have been carried out to reduce the environmental impact of operations. Examples of such measures are: purchasing green electricity, choosing environmental clean cars when purchasing or leasing, and shifting from oil to biofuels for heating the terminals. This also means that they encourage public transport modes and try to give good conditions for these operations. The stakeholders confirm in the stakeholder interviews that their conditions are getting better and better due to the environmental efforts from the managing stakeholder.

There is a large network of actors linked to Arlanda Airport. The terminal manager is not providing any transport services at all; instead the company are coordinating different transport services by different transport companies. All transport operators are complementing each other's transport services; some of the transport operators are also offering the same service which increases the competition between the transport operators'. However, according to the stakeholder interviews, in most cases stakeholders do not see other transport modes besides the air services, as a complement to their own. The stakeholders at Arlanda Airport mostly cooperate with the air service and have mainly their focus on getting best conditions for their own operations.

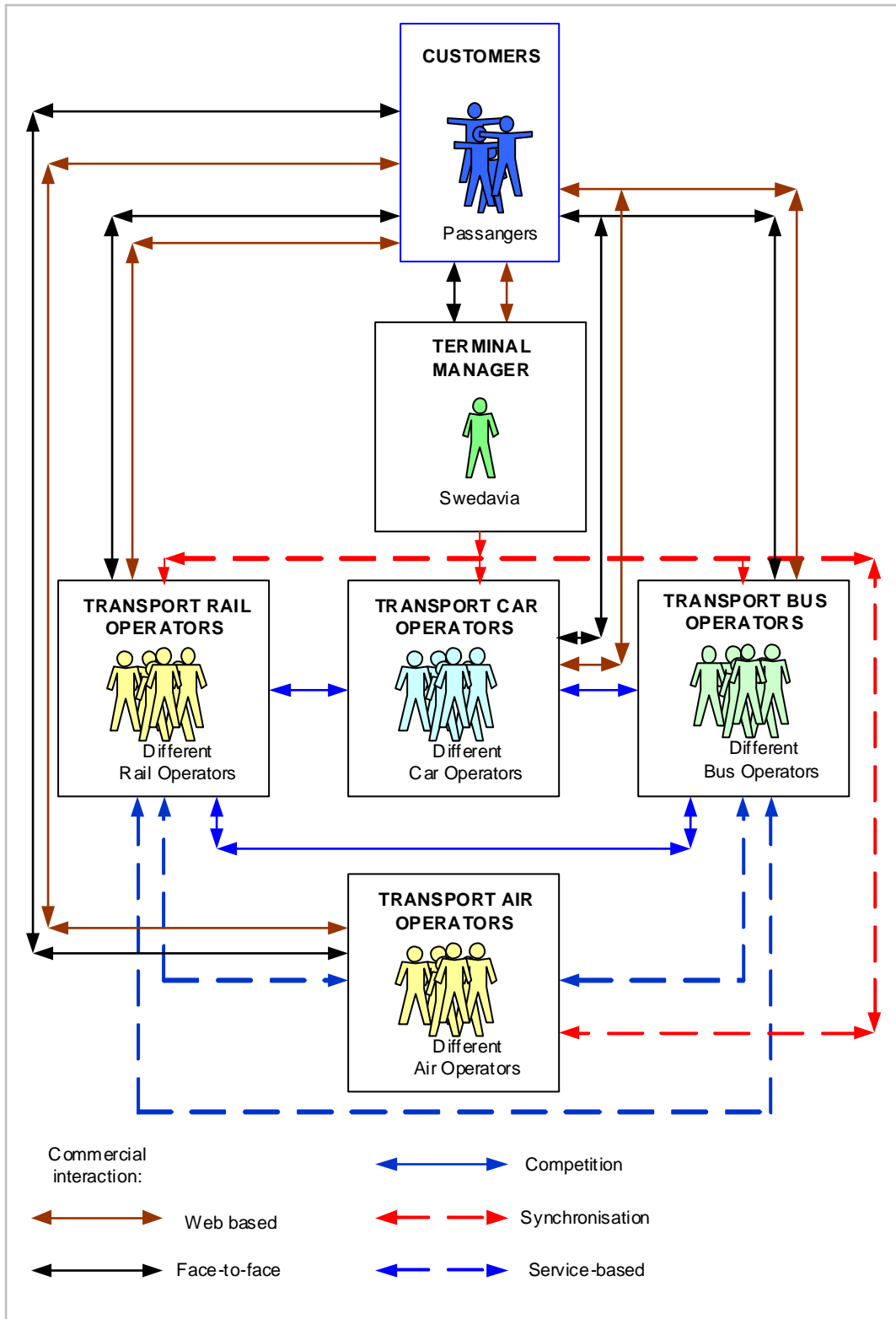


Figure 6.544: Agents and their interaction at Arlanda Airport

The owner of the interchange has many partners, among other transport operators, working in order to fulfill customers' wishes and needs. All transport operators are complementing each other and important.

Beyond the transport services there are also four hotels located at Arlanda Airport and additional six hotels in the vicinity reached by transfer bus which is offering services for the passengers.

6.9.6.9 *Cost Structure (C\$)*

The terminal manager role is to facilitate travelling. The terminal manager reaches for satisfied customers both passengers', transport operators as well as tenants. The cost structure is varying among the different transport operators. Private transport providers' are often forced to offer some added value (value creation) to their passengers' compared to state owned transport providers' this is due to that private transport operators are to 100 % self financed while state owned transport providers' to some extent are financed by the state. Some transport operators offers low-price services, there are both hotels and airline companies offering low-prices while other transport operators focus is on value creation.

6.9.7 Current level of quality of services and customer satisfaction

6.9.7.1 Description general information about the passenger

Detailed information on general statistics about the passengers' (gender, age and travel purpose) has already been given in previous chapter and is not repeated here.

According to the figure below about 25 % arrived to Arlanda Airport with own car or got a lift. 22 % arrived with airplane, 14 % arrived with Arlanda Express (commuter train) 14 % and 7 % arrived with other train operators. 11 % arrived with shuttle bus. 3,9 % arrived with public transport and 2,7 % arrived with taxi.

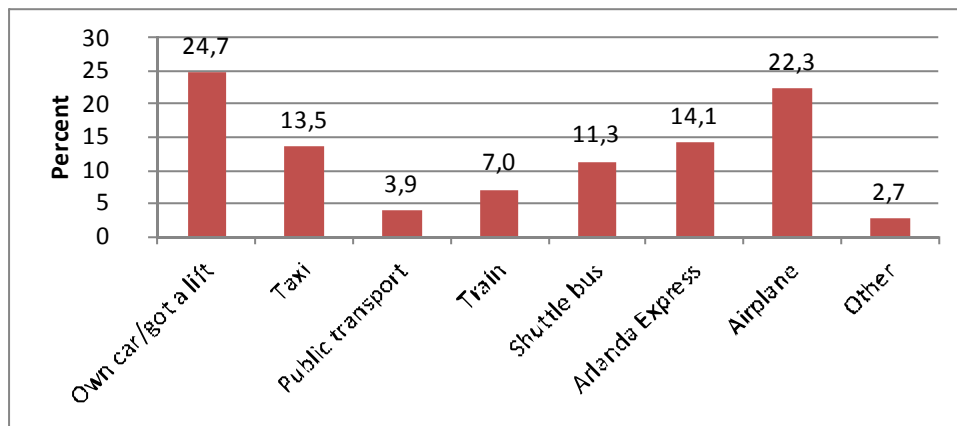


Figure 6.545: Last transport mode to Arlanda Airport N= 993

Distance in kilometers (see figure below) from origin to Arlanda Airport can be summarized as follows: 4, 2 % had a distance below 10 km. Almost 50 % of the passengers had a distance between 10 and 100 km between their origin and the airport. 19 % had a distance between 101 and 400 km. 18 % had a distance between 401 and 700 km and 13 % had a distance beyond 701 km.

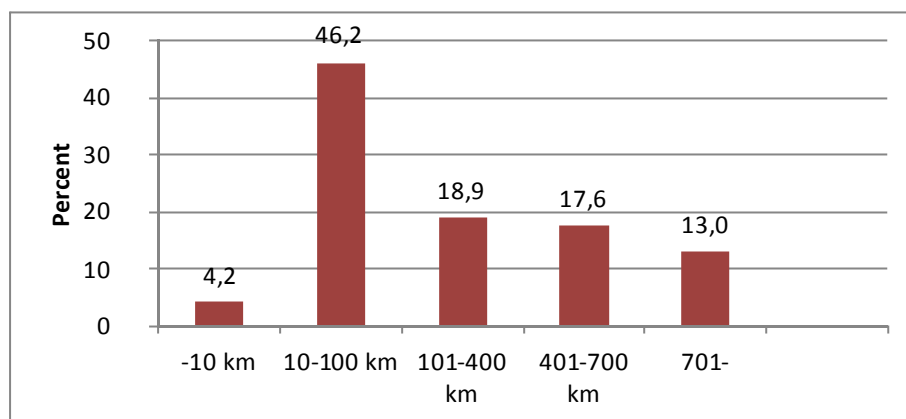


Figure 6.546 : Distance from origin to the airport N= 500

6.9.7.2 Travel demand/Passenger flow

Detailed information on general statistics about passenger flow has already been given in previous chapter and is not repeated here.

As can be seen in the figure below, most of the passengers were pleased with the travel supplies at Arlanda Airport. Passengers were very and quite satisfied with coordinated timetables (63 %) possible travel connections (66 %) and possible combination of transport modes (64 %). Rather few of the passengers are quite or very dissatisfied with travel supplies at Arlanda Airport, coordinated timetables (5 %), possible travel connections (9%) and possible combination of transport modes (6 %).

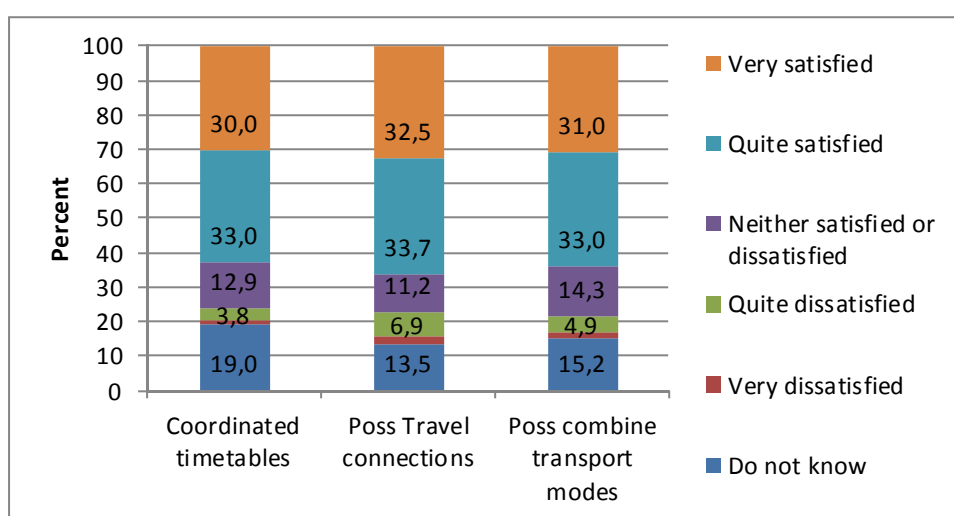


Figure 6.547: Satisfaction with travel supply (Customer survey, part 2a, questions 10-11)

The figure below shows the passengers' most critical factors considering their choice of transport mode.

The passengers stated that following factors are the most important factors when considering transport mode: total travel time (54, 2 %), comfort (52, 1 %) ticket price (34, 8%) and simplicity to transfer/change between different or same transport modes. Furthermore, the punctuality, safety and environmental reasons or company policies did not have major impact.

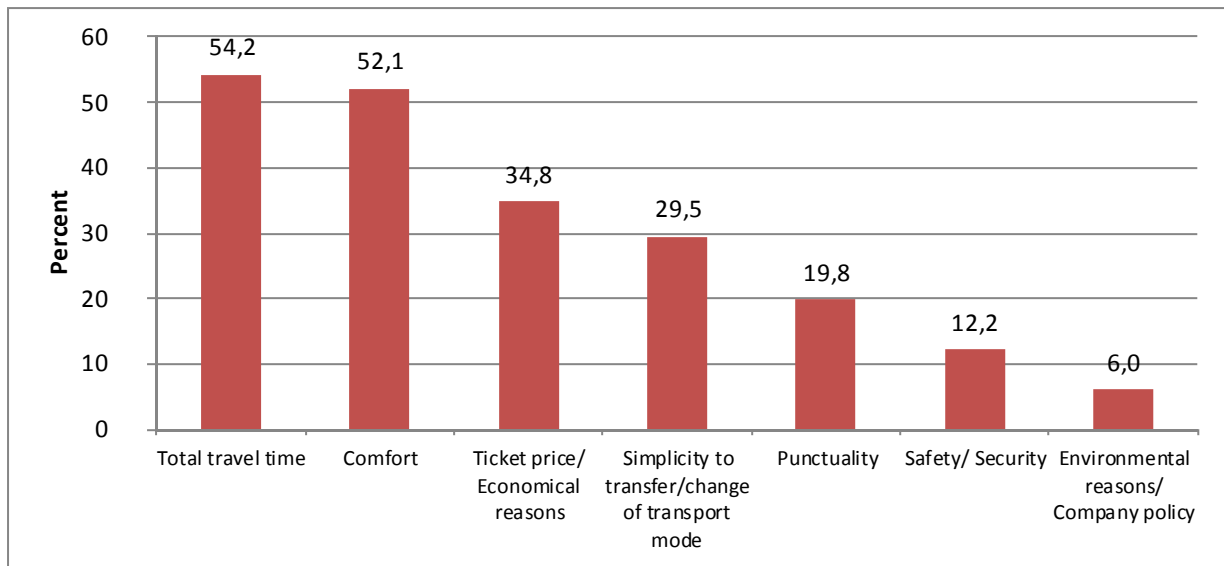


Figure 6.548: Most important factors with influence on the choice of transport mode.

6.9.7.3 Time

When it comes to the passengers' perceived quality of service regarding time aspects it can be concluded that the passengers were in overall satisfied (see figure below). Passengers were quite and very satisfied with: punctuality (71, 4 %) and waiting time (68, 2 %).

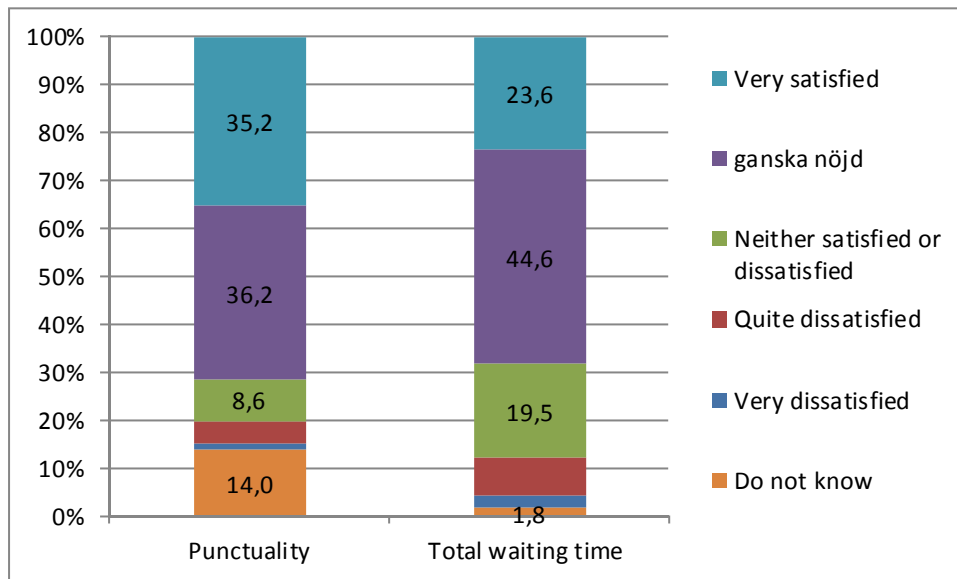


Figure 6.549: Customer satisfaction regarding time aspects at Arlanda Airport

In general passengers are quite or very satisfied with following time aspects at Arlanda Airport (see figure below): check in with staff (71,8%), check in with machine (72%), baggage drop, (64,7 %) special baggage drop (45,5 %.) Regarding the factors displayed in the figure below many passengers doesn't have knowledge and have thereby answered that they don't know if they are satisfied or dissatisfied. Rather few are quite or very dissatisfied with these time aspects: check in with staff (5 %), check in with machine (5,2 %) baggage drop (3,8 %), special baggage drop (3,0 %).

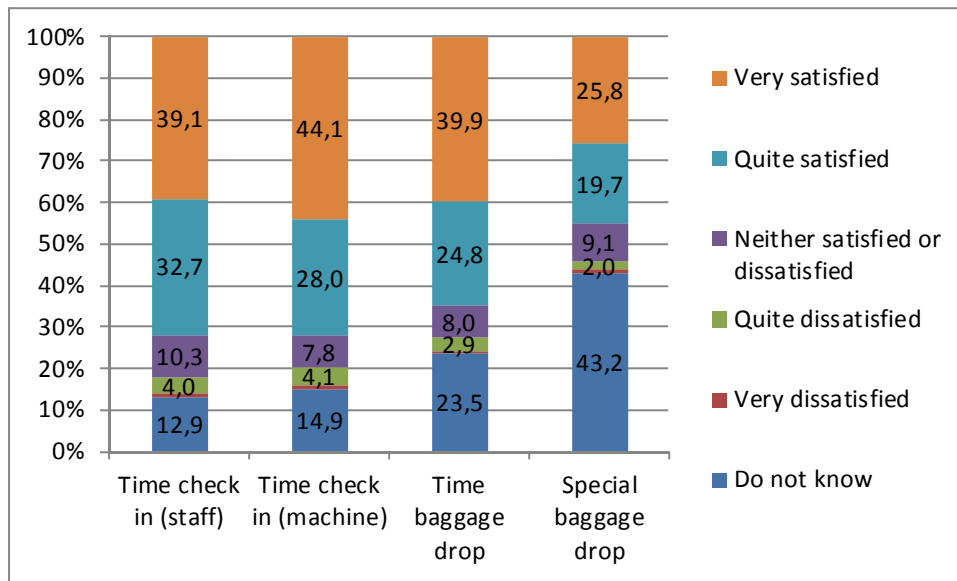


Figure 6.550: Customer satisfaction regarding time aspects at Arlanda Airport

22,2 % of the passengers intended to stay between 31-60 minutes at the airport almost 40 % intended to stay between 61-90 minutes at the airport and 36, 5 % intended to stay for more than 90 minutes. A little share (1, 6 %) intended to stay for less than 30 minutes.

6.9.7.4 Space

In this section describes passenger's satisfaction with the space aspects at Arlanda Airport (facilities and space between gates of mode 1 and mode 2, see figure below).

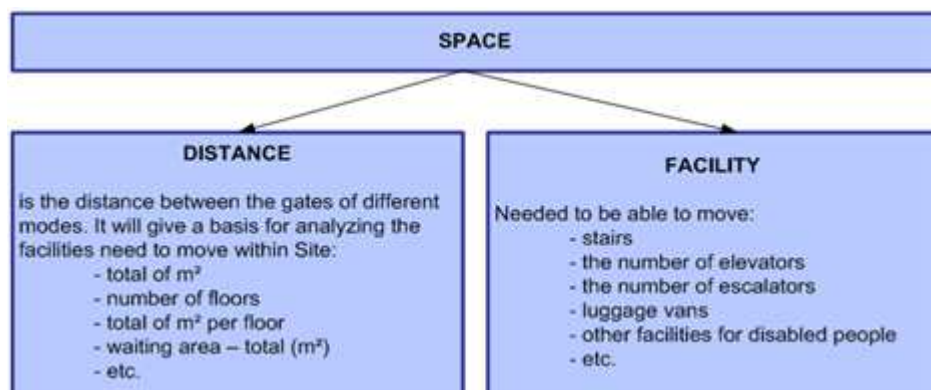


Figure 6.551: Space as measure of the quality of service

6.9.7.4.1 Distance

76, 1 % of the passengers are quite or very satisfied with the walking distance at transfer (see figure below). Almost 5 % felt quite or very dissatisfied with the walking distance at transfer.

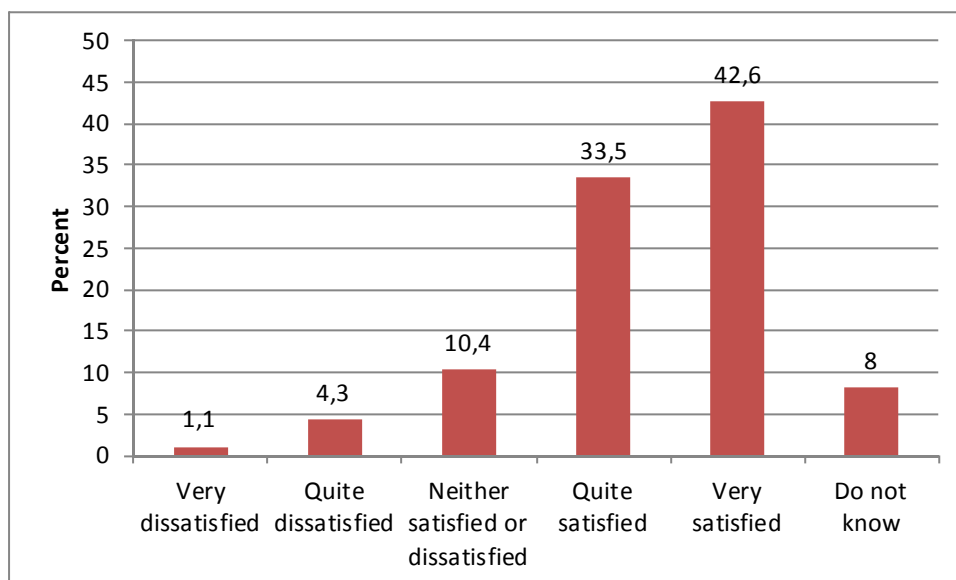


Figure 6.552: Customer satisfaction regarding walking distance at transfer

6.9.7.4.2 Facilities at the site- observations and customer satisfaction

The Table below shows facilities observed at the Airport and gathered from Swedavia.

Facilities and services at site	Number
Trolleys	3500
Meeting point for escort	18
Lounge	3
Visitor center	1
Banking services	6
Drug store	1
Press Bureau	5
Rental car service	6
Other shops	34
Playground	2
Gym	1
Chapel	1
Courier services	3
Lost property	1
Doctor and dentists	1
Laundry	1
Dog Hotel	1
Cafés	16
Restaurants	14
Bar	8
Tax free shops	3
Hotels	4

Figure6.553: Facilities and services at site

The figure below shows that the passengers are in overall quite or very satisfied with facilities at Arlanda airport: total space at the airport (77,4 %), seating capacity at gates (79,3 %), and total seating capacity (71,1 %). Regarding the seating capacity at both gates and the entire airport 9-10 % felt quite or very dissatisfied.

Regarding the access to trolleys, luggage storage and adjustments for disable people a great share has lack of knowledge about these factors. 41,9 % are quite or very satisfied and 2,5 % are quite or very dissatisfied with the access to trolleys. 15,6 % are quite or very satisfied and 4,1 % are quite or very dissatisfied with the access to luggage storage. 10,6 % are quite or very satisfied and 0,7 % are quite or very dissatisfied with the adjustments for disable people at Arlanda Airport.

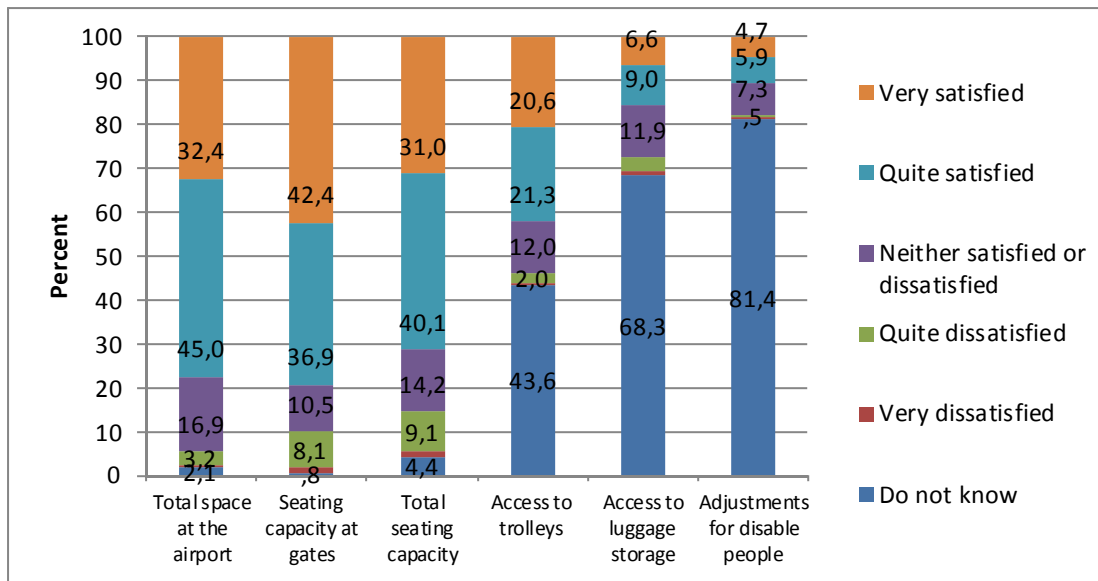


Figure 6.554: Customer satisfaction regarding facilities at Arlanda Airport - part 1

The figure below shows which facilities the passengers have used during their stay at Arlanda Airport. 42,3 % did use escalators, 9,6 % used elevators and 7,4 % used transfer bus. Almost half of the passengers did not use any of the mentioned facilities.

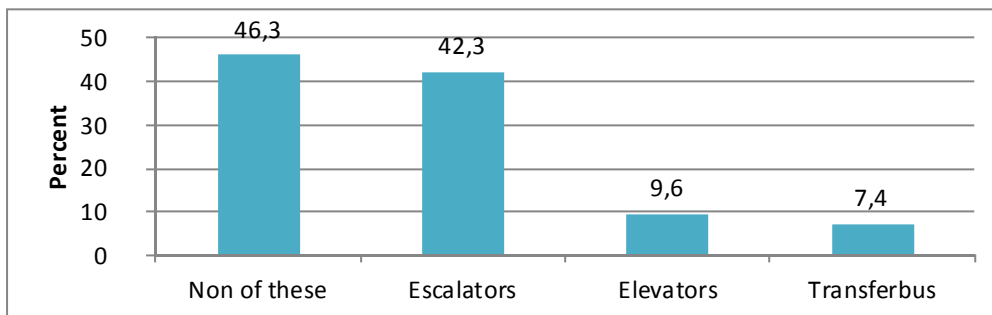


Figure 6.555: Use of facilities at the Airport

The passengers seem to be satisfied with the access to the facilities displayed in the figure below, 81,2% are quite or very satisfied with the service, shuttle bus (81,2 %), elevators (32,4 %) and escalators (71,3 %). Regarding escalators and elevators many passenger have a lack of knowledge about these facilities. Regarding the shuttle bus a moderate share of passenger are quite or very dissatisfied with the service.

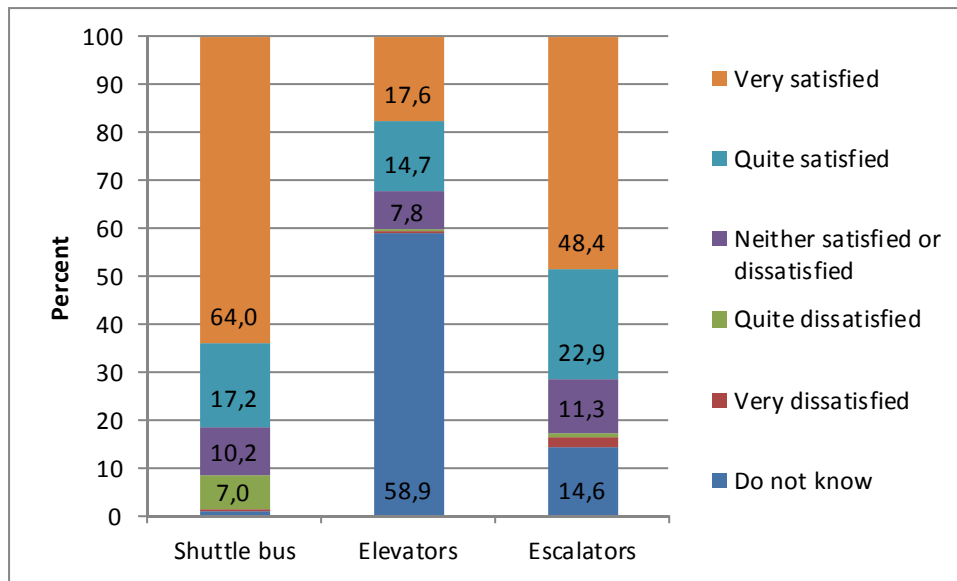


Figure 6.556: Satisfaction with facilities at the airport part 2

The figure below shows that most of the passengers are familiar with the airport. Only 5, 4 percent were not familiar at all with the airport. 75 percent states that they are either quite familiar or very familiar with the airport and additional 20 percent are somewhat familiar.

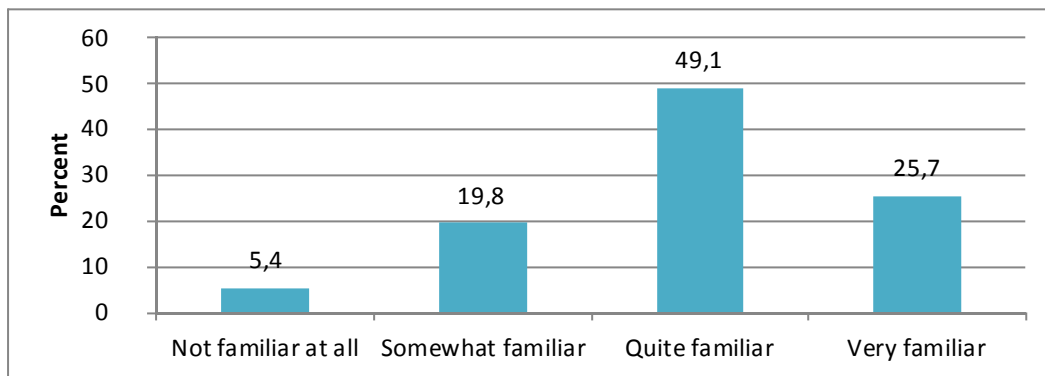


Figure 6.557: How familiar would you say that you are with Arlanda airport?

The figure below shows that the majority of the passengers considered being easy to find their gate at the airport. About 7 per cent consider it was neither hard nor easy to find the gate. 3 percent experiences difficulties in finding their departure.

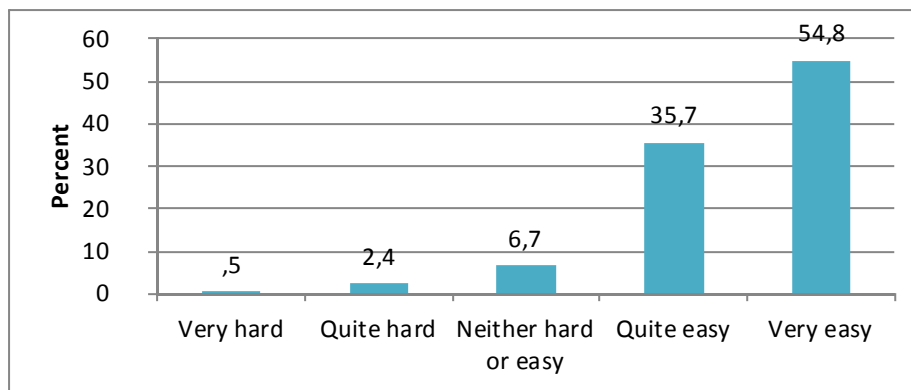


Figure 6.558: How easy or hard was it to find your gate?

As seen in the figure below, only 7 % of the passengers found it difficult to find their gate and consider it to be easier with some kind of measures (see figure below). 93 % had no problems to find their gate and did not have any requirements on additional function to facilitate their way to the gate.

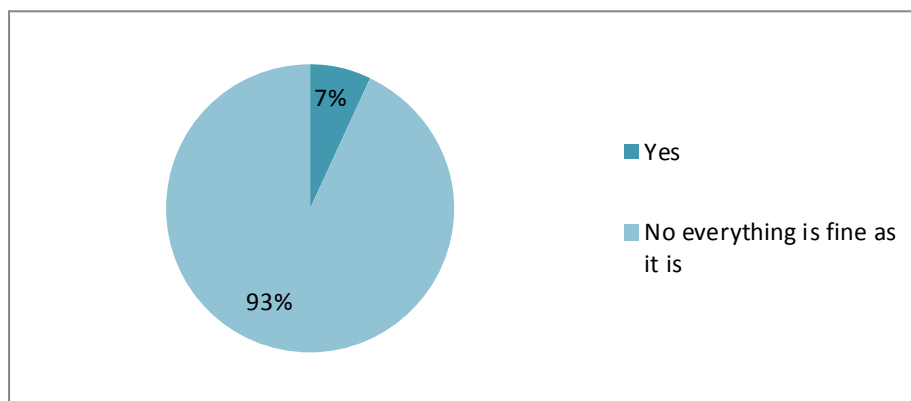


Figure 6.559: Missing functions at Arlanda Airport which would simplify the way to the gate

The question about shortcoming or missing functions at Arlanda Airport was an open question. The respondents had the opportunity to leave their own view about the question.

In combination with the question above regarding if the passengers were missing something which would facilitate their next gate/departure at the airport the passengers had also the opportunity to fill in what they were missing. Most passengers had opinions about information at Arlanda Airport.

Passengers desired measures regarding missing functions at the airport:

Information and signs

- There are opinions about a lack of information regarding connections before the airplane landing at Arlanda airport
- Lack of instructions at arrival area
- Too few service staff at the airport
- Better and (or) more signs
- Gate should also be noted at the boarding card
- More information
- More maps displaying the area and where you are
- Missing signs displaying where to redeem tickets
- Gate information via SMS
- Information through speaker system is too obscure
- Missing an overview-board displaying departures and arrivals
- Missing sign from arriving area to check-in area
- Clearer gate-signs
- Distribution of maps showing the airport

Other

- Confusing and unnecessary to walk through the tax-free store in order to get to terminal 5 for international flights
- More escalators
- Bad logistic at the airport
- Confusing in the arriving area

6.9.7.5 Information, Ticketing and check-in services

The observation about information and ticketing at Arlanda Airport includes the number of information desks, ticketing and check-in counters and how long time the service required. The table below shows the average service time observed at Terminal 5 and Terminal 4.

Observer	Terminal 5 Observation place	Time interval	Total time (minutes)	Total number of passengers
1	Check-in counter No. 83	12:30 – 12:50	20	10
2	Check-in counter No. 83	13:10 – 13:28	18	6
3	Check-in counter No. 83	13:33 – 13:50	17	16
Total:			55	32
1	Check-in counter No. 75	13:10 – 13:30	20	33
2	Check-in counter No. 75	12:30 – 12:50	20	36
Total:			40	69
1	Ticket machine of Express	12:47 – 12:58	11	10
2	Check-in counter No. 75	14:00 – 14:02	2	2
		14:04 – 14:05	1	1
		14:07 – 14:08	1	1
		14:16 – 14:20	4	3
3	Ticket machine of Express	12:37 – 12:44	7	13
4	Ticket machine of Express	14:00 – 14:20	20	0
Total:			26	30
1	Information counter for tickets	12:33 – 12:53	20	15
		12:50 – 12:53	3	4
2	Information counter for tickets	13:58 – 14:05	7	7
		14:07 – 14:12	5	5
		14:13 – 14:14	1	2
Total:			36	33
1	Check-in self-service machine for SAS	13:23 – 13:44	21	20
2	Check-in self-service machine for SAS	13:26 – 13:45	19	11
Total:			40	31
Observer	Terminal 4 Observation place	Time interval	Total time (minutes)	Total number of passengers
1	Check-in self-service machine for SAS	14:40 – 15:00	20	7
2	Check-in self-service machine for SAS	14:58 – 15:20	22	15
Total:			42	22
1	Check-in self-service machine for other airline	14:43 – 15:03	20	2
2	Check-in self-service machine for SAS	15:04 – 15:24	20	15
Total:			42	17

Figure6.560: Data from observation of service time

In general, the passengers were satisfied with the quality of service regarding information and ticketing at Arlanda Airport (see the figure below). However, great shares of the respondents have a lack of knowledge about the questions concerning ticketing. This can probably be explained by that they arranged their tickets before arriving to Arlanda Airport. The customer satisfaction regarding the questions about information are high, clearness and accuracy (84,7 %) and the number of information signs (82,6%). The share of dissatisfied passengers regarding ticketing and information are very low, however, information about possible travel connections could be improved.

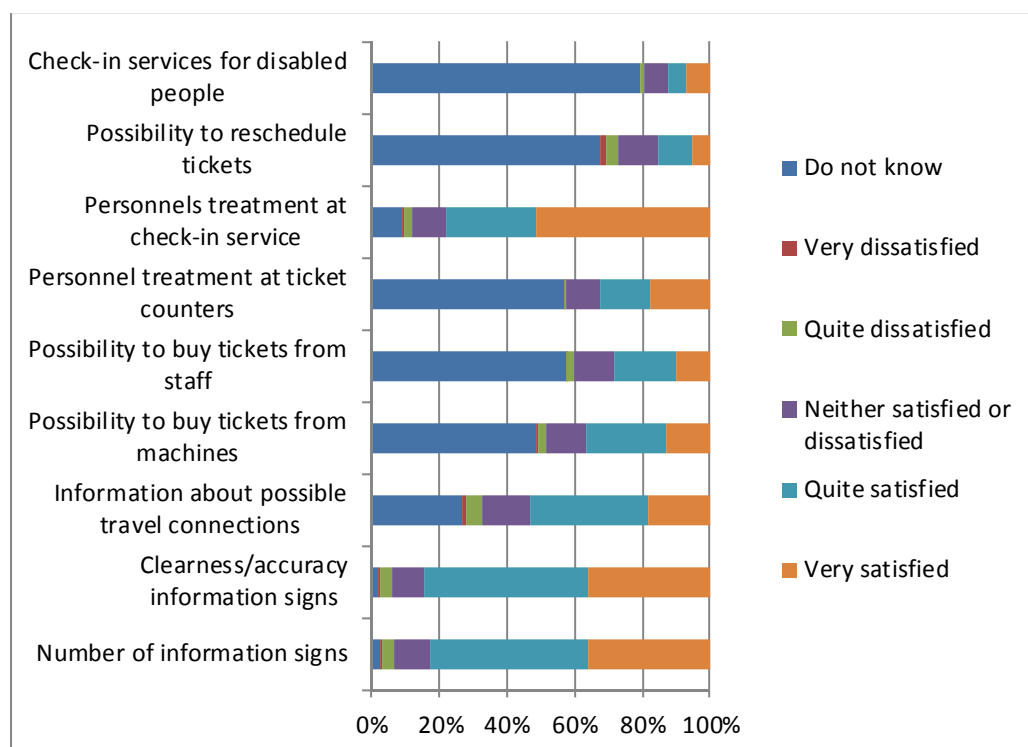


Figure 6.561: Satisfaction with information and ticket sell at Arlanda Airport

The figure below shows that most of the passengers are satisfied with the provided information at Arlanda Airport. 6 % state that they want more information about alternative transport modes/ routes to their final destination. 76 % of the passengers are satisfied and have no requirements for additional information. 18 % answered do not know.

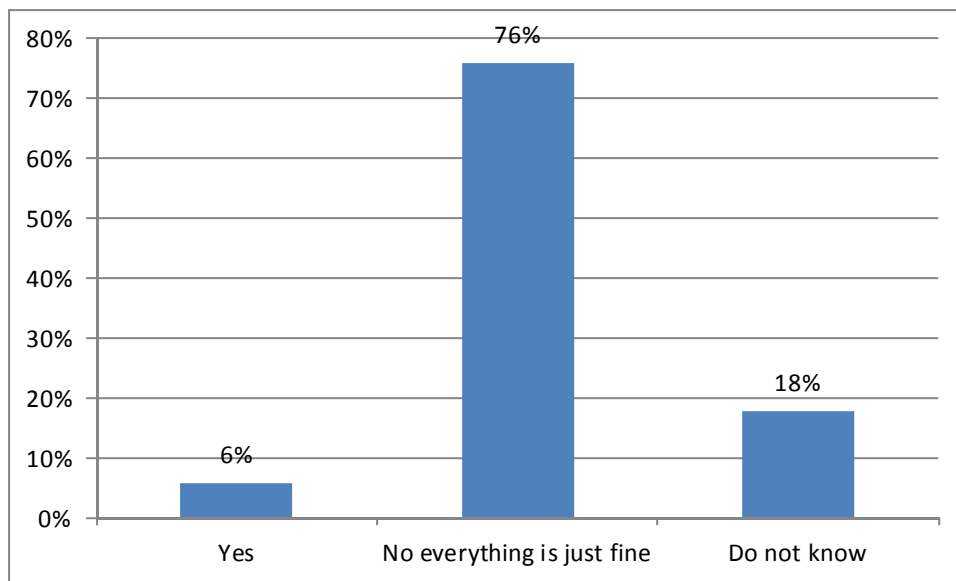


Figure 6.562: Information about alternative transport modes/ routes to final destination

The question above included an open question regarding the passengers' need of additional information about alternative travel modes/ routes to final destination. The passengers' had following need/desires:

- Information about connection to other transport services
- Information about transfer buses to hotels
- Information about cashless handling on buses
- Brochures including possible travel connections (all provided transport services) from Arlanda Airport
- Timetables for transfer buses
- Personal help/ Guidance on Arlanda Airport
- Information via sms
- Detailed map for transfer buses stops

6.9.8 Added value at the site

In this section are additional facilities at Arlanda Airport described, these facilities are providing added value for customer. This is described by three figures.

The figure below shows that most passengers are satisfied with the facilities displayed in the figure at Arlanda Airport. However some facilities are highlighted with moderate share of quite or dissatisfied passengers. These areas are access to restaurants, work facilities, lounges, Internet, resting places. Areas with a high customer satisfaction are following: access to, kiosks, cafés, restaurants and the access to toilets. However it should be noticed that many people in the survey has a lack of knowledge about the factors in the figure below.

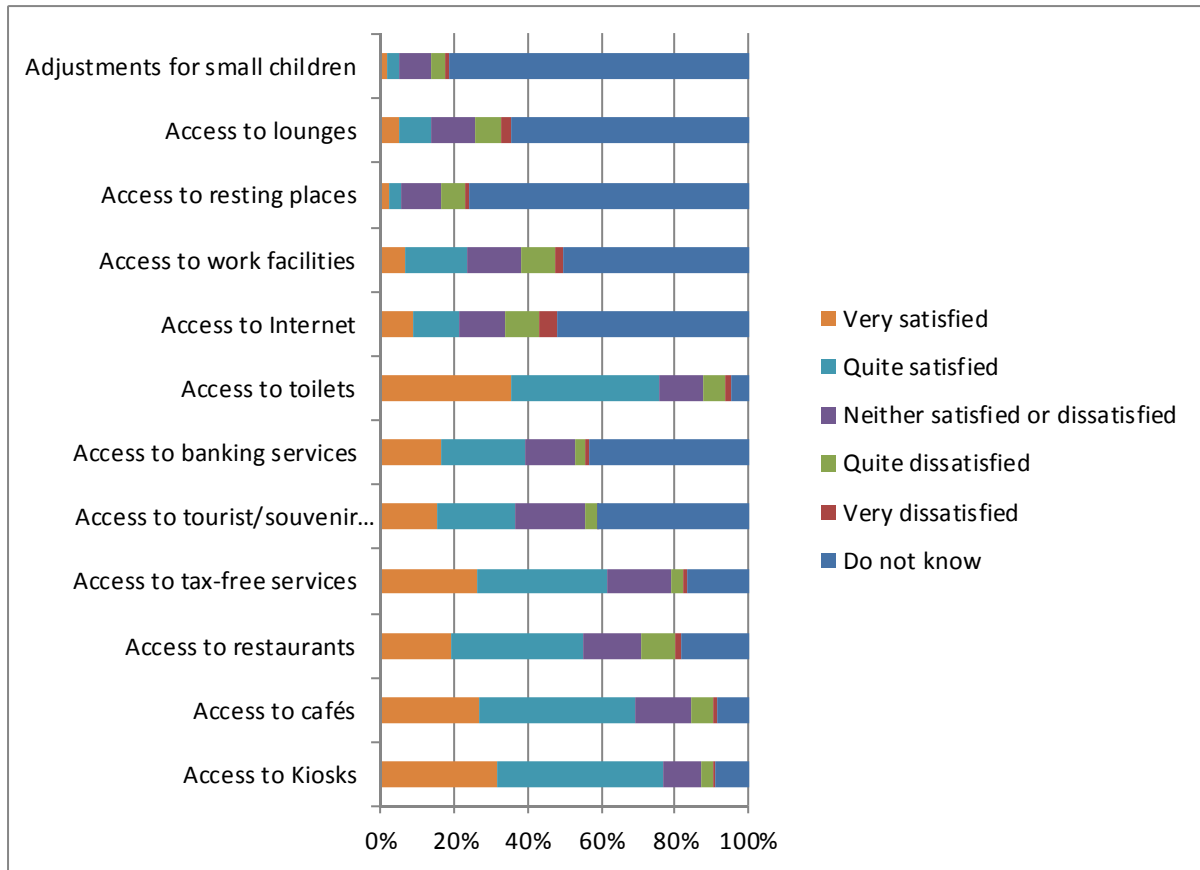


Figure 6.563: Customer satisfaction regarding facilities at Arlanda Airport- part 3

The figure below shows that a great share of passengers have a lack of knowledge about these factors, this is probably due to that different passengers have different needs when travelling. The facilities which people have least knowledge about are following: opportunity to travel with pets, support for disable people and the access to MC-parking.

Very few are quite or very dissatisfied with these factors, however moderate shares of passengers are dissatisfied with the cleaning of the toilets and the access to car-parking at the airport.

The passengers are most satisfied with the following facilities: access to buses, cleaning of the airport, cleaning of toilets, air quality, atmosphere at the airport and the security.

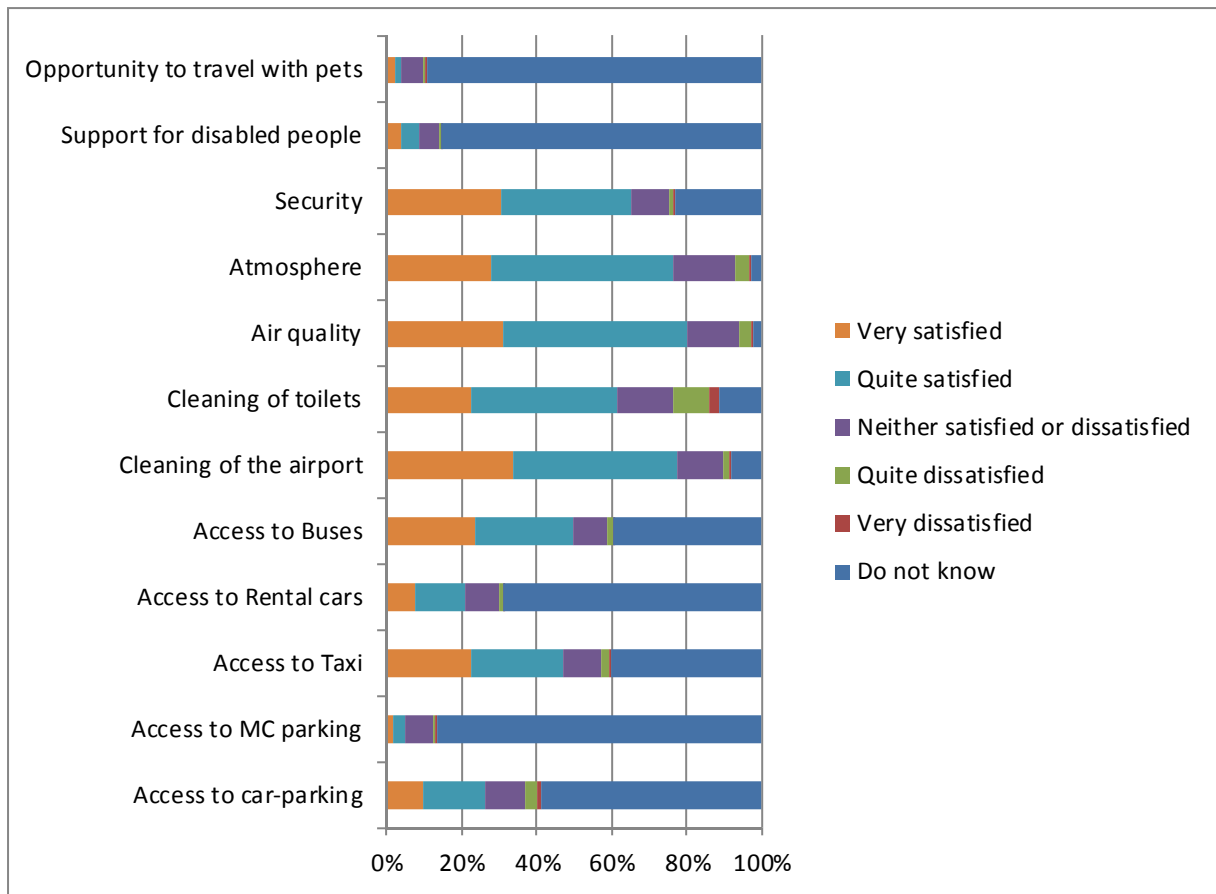


Figure 6.564: Customer satisfaction regarding facilities at Arlanda Airport part 4

6.9.9 Analysis for improvement of interconnectivity

6.9.9.1 Comparison between customers and stakeholders

The current level of quality at Arlanda airport (according to customer survey) is very high. Passengers are satisfied by: punctuality (71,4%), waiting time (68,2%), walking distance (76,1%), check in with staff (71,8%), check in with machine (72%), seating capacity at gates (79,3 %) and total seating capacity (71,1 %). It is important to point out that 76 % of the customers are satisfied and have no requirements for additional information.

Improvements are possible on a very high level. Swedavia is now launching a major investment at Arlanda Airport. Over three years a billion Swedish kronor will be invested in measures to increase capacity and enhance quality. The objective is to create Scandinavia's most modern and passenger-friendly meeting place and airport.

Stakeholders at Arlanda Airport want to increase the number of passengers who are using public transport (bus and rail modes) to and from Arlanda. Passengers access the airport mainly by car and taxi (ca 40%). One explanation can be that passengers who are coming from Stockholm and nearby cities use cars and taxis.

6.9.9.2 Validation of findings in WP3/WP4

In order to further expand the airport there is a need of decreasing emissions from road transports to and from Arlanda Airport. "Last mile problem" from WP3/WP4 remains. It is important to find solutions to decrease usage of cars to and from Arlanda and/or to persuade more people to use public transport.

6.9.9.3 Missing links and new Value Proposition

The Figure below shows passengers' and employees' 'contribution' to the total emissions of CO₂ at Arlanda Airport.

Arlanda Airport has already implemented several measures. For passengers who choose to ride in a taxi, there is already a separate eco-taxi queue outside the airport terminals, in front of the other taxis. The airport's target is that all taxis that serve Arlanda Airport shall be eco-taxis by 2011.

The airport also gives preferential treatment to "clean" cars, for example by allowing them to park as close as possible to the terminal for passengers. A total of 190 parking spaces were 2007 reserved for clean cars at Swedavia's parking facilities at Arlanda.

Still, there are some issues which have to be solved:

3. How to decrease emissions from passengers' cars (parking and picking-up/leaving someone at the Arlanda, see figure below)
4. How to decrease emissions from employees' cars (parking, see figure below)

Traveller (group)	Transport mode	CO ₂ emission (ton)	Share	Total CO ₂ emissions (ton)	Total share
Passengers	Own car (parking)	25 917	14 %	110 691	61%
	Travel by car (to pick-up and leave someone at the Arlanda)	67 027	37 %		
	Rent-a-car	971	1 %		
	Taxi	16 776	9 %		
Staff at Arlanda Airport	Own car (parking)	24 052	13 %	24 052	13 %
Total CO ₂ emission (passengers and staff)				134 743	74 %

Figure 6.565: Car transport-services and carbon emissions (Source: WSP 2008)

Arlanda's passenger is aged around 40, mobile, urban resident, early adopter and with active lifestyle. 54 per cent of employees work shifts: 19 per cent work between 05:30 and 20:00 and 35 per cent work between 20.00 and 05:30. 25 per cent of employees works between 08:00 – 17:00 and the other 20 per cent of employees have other working hours.

Our new value proposition is to enable passengers and employees to use bus and rail transport services to and from Arlanda Airport.

6.9.10 Actions for improvement of interconnectivity

6.9.10.1 Proposal

In order to decrease carbon emissions it is important to increase usage of public transport. Our value proposition is: to provide integrated and qualitative transport services for passengers and employees and thereby offer integrated information and ticket-selling. Target is to enable passengers and employees to use bus and rail transport services to and from Arlanda Airport.

According to the customer survey there are several factors which are important for passengers when they are choosing transport mode:

- Total travel time (54,2 %)
- Comfort (52,1 %)
- Ticket price (34,8 %)
- Simplicity to transfer (29,5 %)
- Punctuality (19,8 %) and
- Safety (12,2 %).

If public transport should be able to compete with the cars these factors must be improved.

6.9.10.2 Description of new business model

6.9.10.2.1 Customer Segments (CS)

Our proposal includes following customer segments:

1. Passengers who are picked-up and dropped at Arlanda.
2. Passengers who are using a car to and from Arlanda and need parking place.
3. Employees who are using a car to and from Arlanda and need parking place.
4. Conference and meeting attendees who are using a car to and from Arlanda and need parking place.

6.9.10.2.2 Value Proposition (VP)

Our value proposition is "Integrated public transport service". Swedavia should provide for passengers and employees an integrated and qualitative public transport service and thereby offer integrated travel information and ticket-selling.

Following rail and bus transport services should be integrated:

- International rail service
- Interurban rail service
- Computer train service
- International bus service
- Interurban bus service
- Interurban bus service
- Urban bus service
- Shuttle service

Integrated public transport service should have following quality in order to decrease usage of cars:

1. **Time-effective public transport services:** Total travel time by public transport (door-to-door) should not take a much longer time compared to car. This quality factor important for Arlanda's passengers and employees (see chapters 5.3 and 6.1).
2. **Frequent public transport services:** The frequency of public transport services must be high. This quality factor will increase comfort for passengers and employees. These target groups do not need to wait at Arlanda several hours, especially passengers who are living in middle and north Sweden. 52,1 per cent of passengers choose their transport mode depending on comfort.
3. **Lower ticket-price of public transport services:** Most companies are not willing to reduce ticket prices. Increasing of parking fees can be a complementary measure to lower ticket-prices. Our opinion is that there is a need of both measures. Deployment of only one measure, for example increased parking fees, can increase the number of lifts (to pick-up and leave someone at Arlanda).

6.9.10.2.3 Channels (CH)

There are different channels to: plan travel, get travel information and by ticket.

Channels for travel planning are:

1. mobile services - for example an app
2. Arlanda's and transport-operator's websites
3. Information' displays on Arlanda Airport

Channels for ticket-selling are:

1. Mobile services
2. On-line (Arlanda's website)
3. Ticket-machines

Channels for spreading of travel information:

1. Mobile services
2. Websites (Arlanda's website and transport-operator's websites)
3. Information desks at Arlanda Airport

These channels imply needs of:

1. Coordinating of time-schedules between rail and bus transport-operators
2. Common ticket selling service (rail and bus)
3. Common travel planning service (rail and bus)

Swedavia should raise awareness about this "Integrated public transport service".

6.9.10.2.4 Customer Relationships (CR)

Customers interact with Swedavia by:

1. Information desks
2. Ticket-machines
3. Swedavia's website
4. Arlanda's website

5. Companies' websites (rail and bus transport-operators)

6.9.10.2.5 Revenue Streams (R\$)

Revenue source for Swedavia is lower emissions at Arlanda Airport. Rail and bus transport-operators' revenue sources are tickets, supplementary from 250 companies at Arlanda Airport and supplementary from the Swedish government. Employees at Arlanda Airport should have possibility to buy subsidized public transportation tickets. Public rail and bus transport operators who are cooperating for integrated public transport services should be subsidized by the Swedish government.

6.9.10.2.6 Key Resources (KR)

Swedavia's key resources (to be able to offer an integrated public transport service) are buildings, mark and information about passenger flows to and from Arlanda Airport. Information about pick and non peak periods can be used to plan integrated public transport services.

Rail and bus transport-operators own buses and trains. These operators proved also human resources (for example drivers). Arlanda Express owns infrastructure (Arlandabanan) and it means that the company is allowed to collect fees from other transport operators providing services at Arlandabanan.

6.9.10.2.7 Key Activities (KA)

With this new value proposition Swedavia's activity is to provide an integrated public transport service. Swedavia's market is both long and short distances to and from Arlanda Airport.

6.9.10.2.8 Key Partnerships (KP)

Swedavia needs to have agreements with following companies: bus transport-operators, rail transport-operators and companies at Arlanda Airport. These agreements should regulate revenue share and responsibilities.

6.9.10.2.9 Cost Structure (C\$)

Our value proposition is based on minimizing costs for the passengers (lower ticket-prices).

6.9.10.3 *Description of proposed service using the concept of Agents*

6.9.10.3.1 Agents

6.9.10.3.2 Objectives and Goals

The main objective for all partners is to increase usage of public transport services. Swedavia's and bus transport operators' goal is to cut emissions to and from Arlanda Airport.

Transport operators (rail and bus transport operators) have also following objectives:

1. To increase the number of customers (passengers)
2. To increase the number of satisfied customers (passengers)

6.9.10.3.3 Strategies

Cooperation between Swedavia, all companies at Arlanda Airport and public transport operators is the main strategy to be able to increase usage of public transport services to and from Arlanda Airport.

6.9.10.3.4 Interactions between agents

All interaction between agents must be regulated by agreements.

6.9.10.3.5 Graphical representation

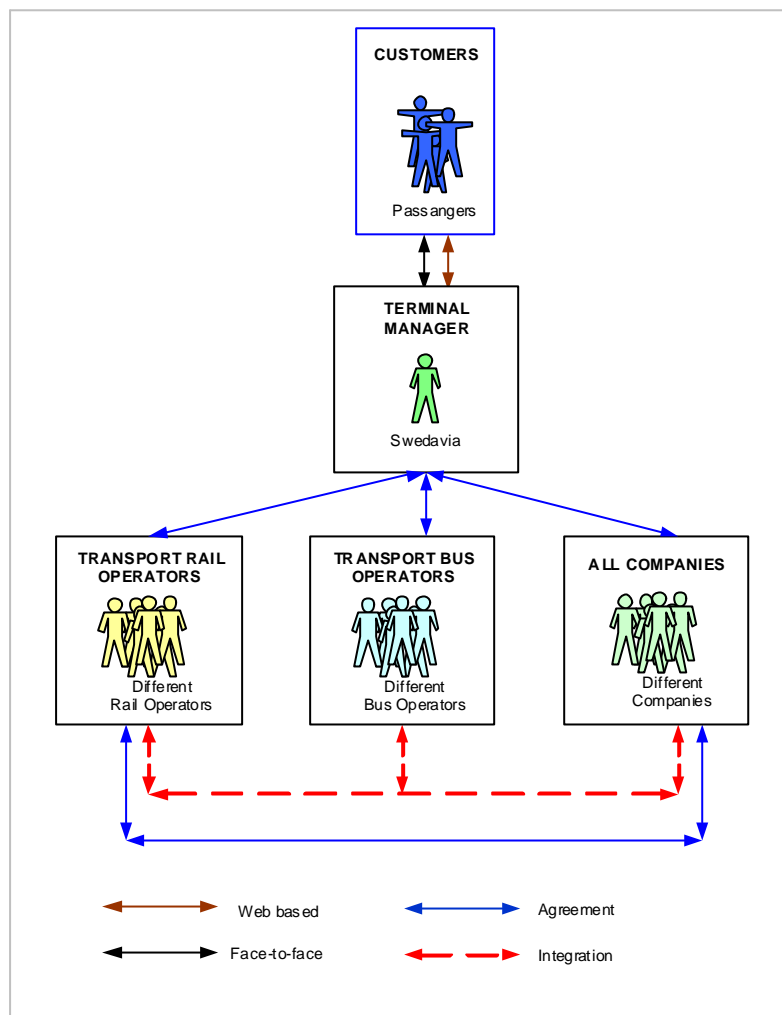


Figure 6.566: Interaction between agents

6.9.10.4 *Functions and Indicators to show enhancement*

6.9.10.4.1 Functions of validation

Our value proposition includes following functions:

1. **An integrated time-schedule:** e.g. passengers who live in Falun (ca 200 km north of Arlanda) can have access to frequent routes to the Arlanda, either by bus or train or by combined transport modes (bus and train).
2. **An integrated and low-price ticket:** e.g. passengers can buy one ticket to a low price (it should cost less than a travel by car) and use it door-to-door (from home to the Arlanda Airport).
3. **An integrated travel information:** e.g. at the same website information about bus and rail transport services can be available.

6.9.10.4.2 Indicators of validation

The Table below is comparison between costs for three different transport services (car, rail and bus) when one passenger have to attend a meeting at Arlanda Airport.

Origin	Destination	Meeting time	Car	Train	Swebus
Falun	Arlanda	08:00 - 16:00	Bensin t/r- Ca 80 € Parking/day – ca 11 € Time: ca 2 h	Ticket price t/r: ca 110 € 2 departures from Falun (03:37 and 05:37) Time: 02 h 20 min 3 departures from Arlanda (16:08; 16:48;17:08) Time: 02 h 30 min	Ticket price t/r: ca 60 € 1 departure from Falun (08:40) Time: 04 h 10 min 1 departure from Arlanda (12:00) Time: 05 h 30 min

Figure6.567: Comparison between three different transport services

According to our study the meeting/conference’ passengers are not at all able to choose bus transport services. Rail transport services are an alternative, but the price is higher and it is more time consuming (“door-to-door”). If we have in mind facts as total travel time, comfort and ticket price it is obvious that passenger shall choose car instead of train.

An integrated time-schedule can generate density of transport services and possibility to combine different transport services (bus and rail).

An integrated and low ticket-price can generate get passengers to use bus and rail transport services instead of cars.

It is time consuming to gather information about all bus departures from e.g. Falun to Arlanda. There are different private-owned companies and all these companies have own time-schedules and prices. Integrated travel information enable passenger to make faster decisions (e.g. to take a car or train).

6.9.10.4.3 Methods and tools

There are several methods and tools which can be used to calculate the functions and indicators, and thus to evidence the benefits, for example customer survey and statistical data from transport operators and Swedavia.

6.10 Extension of the Adriatic - Ionian corridor - from Peloponnese to Crete Greece

6.10.1 Main features of the site

In the current situation, the maritime transport (ferry) services linking continental Greece - including the Peloponnese- to Crete are mainly based on the Piraeus hub port; passenger flows coming from the Adriatic corridor and having Crete as final destination, are oriented from the port of Patras to the port of Piraeus, primarily, through the road transport network (private cars or bus services) and then ferry services to Crete. The site for this Case Study is the corridor Patras- Piraeus- Crete.



Figure 6.568 Map of the corridor Patras- Piraeus- Crete

However, considering the network and corridor configuration, the port of Patras is the “crucial” node of the Case Study. The port of Patras is located in the north-west of the Peloponnese and represents the main western gate of Greece. It is the network component that would allow the required shift of passenger flows from the port of Piraeus (current situation) to the ports of

southern Peloponnese and mainly the port of Kalamata (objective of the case study). Consequently, the port of Patras was selected as the appropriate site to realize the customer survey.

The port is situated in the city of Patras, the 3rd largest city in Greece with approximately 225.000 inhabitants. Patras is the capital of the Prefecture of Achaia located in northern Peloponnese, 215 km west of Athens. The port has an important role in the economic development of the city, as well as of the wider region.

The port has four main piers and wharfs of approximately 3.000 m total length and 8.5-10.5m depth. It's capacity allows passenger ferry ships up to 220 meters length. The port has a (2.932 m²) 2-floor Passenger Terminal with passenger lounges, shipping line agency offices, Customs office, duty-free stores and other services. It serves more than 50% of the international maritime passenger flows in Greece (1.248.000 passengers out of 2.529.000 in total, 2005 data). The port offers a free parking area at its south end with a capacity of 210 cars. From this parking area there is a bus service connecting the port with the city centre.

Regarding the inter-regional inland connections of the port, there is:

- A railway terminal
- An interurban bus station,

Both in the proximity of the port's main entrance but outside the port zone. The railway terminal is located just beside the port zone (a walking distance of 3 minutes) while the interurban bus station is located at a distance of 300 meters from the main entrance.

The existing railway infrastructure is of a single narrow (metric) gauge of railway track, which crosses the city of Patras and links the port and the city of Patras to Athens on the one direction and to the city of Kalamata in southern Peloponnese on the other. A new standard gauge railway line linking Patras to Korinthos and Athens is currently under construction.

Finally, the port and the city of Patras are connected to the national and Trans-European road network. A new motorway between Patras and Korinthos is under construction (segment of TEN-T road section Athens-Patras) and the National Road Patra-Pyrgos leads to Pyrgos, Ancient Olympia, Kyllini and Kalamata.

6.10.1.1 Identification of the site

The “site” is a wider geographical area that covers the corridor Patras – Piraeus – Crete. The distance between Patras and Piraeus is 210 km and Piraeus – Crete is 172-200 miles depending the port of northern Crete to be reached.

Patras - Piraeus	210 km
Piraeus - Iraklio	200 miles
Piraeus - Chania	172 miles
Piraeus - Rethimno	186 miles

Figure 6.569 Distances between the nodes

Transport Mode Geographical coverage	Rail	Bus	Air	Car	Ship and Ferry
Long distance services > 100 km	<i>Interurban rail service</i>	<i>2) Interurban bus service</i>		Taxi Private Car Rental Car	Port-to Port Ferry Service
Short distance service < 100 km	<i>Metro service</i>	<i>Urban bus service</i>		Taxi Private Car Rental Car	

Figure 6.570: Long-distance services per mode and short distance services per mode

The examined corridor consists of two legs:

- A) Patras- Piraeus
- B) Piraeus- Crete

Concerning the first leg (215 km) the connection is realized by either bus, Car or rail.

The Interurban buses Authority Company (KTEL of Achaia S.A) has 32 itineraries per day (between 12.30 pm to 21.30 each half hour) to the center of Athens. From the center of Athens there is the possibility to take a bus, metro or taxi to reach the port of Piraeus.

Currently, due to the national policy for the reduction of the number of the national railway network lines, the railway connection of the port of Patras to Piraeus is realized via the city of Kiato (distance of 108 km). There are 9 itineraries per day connecting the railway stations of the two cities and from Kiato to Piraeus there are 19 itineraries daily (from 4:30 am to 22:30 pm each hour).

Concerning the second leg a port to port Ferry service is offered. In the port of Piraeus three (3) private operators are activated realizing the route Piraeus – Crete. The existing connections from the port of Piraeus are to Iraklio and Chania.

Piraeus – Iraklio 3 itineraries per day

Piraeus – Chania 2 itineraries per day

6.10.2 Method for data collection

6.10.2.1 Observations and collected material

The specificity of the Case Study “Extension of the Adriatic- Ionian corridor from Peloponnese to Crete” is the fact that the site under study is not a single nodal location but a corridor: the corridor Patras- Piraeus- Crete. This specificity differentiates the way some topics in present report are treated.

Considering the corridor configuration, the port of Patras is the crucial and decisive node for the Case Study and it was selected as the appropriate site to realize the customer survey. Data used in this report have been based on observations and collected through the customer survey and interviews with prime Stakeholders.

6.10.2.1.1 Transport demand/Passenger flow

Transport demand on the Patras – Piraeus – Crete corridor has been estimated through retrieval of the following data:

- The transport demand/passenger flows in the port of Patras
- The touristic flows to Crete
- The number of passengers using the examined corridor

Data sources were the National Statistic Service, the Greek Tourism Organization and the Authority of the Port of Patras.

6.10.2.1.2 Time data

Time relevant data (transfer data, waiting time) were collected through all available sources: Customer survey (Questionnaire (Revealed data), Section B), where the entire passenger trip is decomposed into legs; data collected through interviews with stakeholders of the current situation; observations made on the site.

6.10.2.1.3 Space data

In this Case Study, the “site” is practically the wider geographical area that covers the corridor Patras – Piraeus – Crete. The data concerning space concerns the geographic characteristics of the area.

6.10.2.1.4 Information, Ticketing and Check-in Services data

Data concerning Information, Ticketing and Check-in Services were collected during interviews with stakeholders; site observations, which were a helpful tool in understanding the process and, finally, the customer survey (Questionnaire, Section C). More specifically, information collected concerns the Interchange level, with respect to:

- Services offered at the interchange: means to reach the next transport mode, walking time, waiting time, information displays, signposting, travel services (Tickets/Booking, Luggage handling, Coordination of timetables between different networks, other services/facilities (Banking Services, Catering Services, Newsagents, Shops, Facilities for disabled people, Seating space etc).
- Customers’ evaluation of the performance of the services offered and also rating of the importance of each type of service.

6.10.2.2 *Customer survey*

6.10.2.2.1 Sample size

In order to define sample size in the customer survey, the annual passenger flow was used and analyzed. The annual flow is approximately 1 million passengers, with peaks of 200,000 during August and 35,000 during February. An average daily flow of 90,000 passengers was taken in order to calculate the typical sample. As the survey mainly targeted boarding passengers who had already used the port services, the statistical population was calculated to 45,000 passengers. A sample of 500 surveys was considered statistically reliable. Finally, 560 passengers participated in the survey and more than 600 Stated Preference experiments were completed, based on 270 questionnaires.

6.10.2.2.2 Distribution of the questionnaires

For the needs of this Case Study, the customer survey and related data collection is considered the cornerstone for investigating the proposed business model. The customer survey has been based on a well-structured questionnaire.

The questionnaire practically contains two main –and large- parts: the first part collects Revealed Data while the second part collects Stated Preference data.

The first part contains five (5) sections, namely A, B, C, D and E.

- Section A deals with general travel information (origin-destination, travel in group or not, trip purpose, whole trip duration etc)
- Section B deals with information concerning modal choice of customers, decomposing the whole trip of passengers into legs
- Section C deals with information at the Interchange level:
 - services offered at the interchange: means to reach next transport mode, walking time, waiting time, information displays, signposting, travel services (Tickets/Booking, Luggage handling, Coordination of timetables between different networks, other services/facilities (Banking Services, Catering Services, Newsagents, Shops, Facilities for disabled people, Seating space etc).
 - the customers evaluate the performance of the services offered and also rate the importance of each type of service.
- Section D deals with Alternative Routes, not selected by the customers for reaching their destination and focuses on the criteria of their choice (cost, travel time, comfort, quality of service at the means, quality performance of the interchange used etc).
- Section E collects data related to the Personal Profile of customers: age, gender, profession, income, nationality, educational level.

Finally, the second Part (Section F) performs Stated Preference experiments in order to assess the attractiveness of the proposed business model.

The first Part of the questionnaire is of common interest for this Case Study 5 (presented in this report) and for the Case Study Port of Patras. More specifically, the Sections A, B, C and E of the questionnaire are common for both Case Studies for reasons already analyzed in details in this report.

The second part performs Stated Preference experiments. This Part is exclusively related to this Case Study's needs. The aim of Stated Preference experiments is to assess the attractiveness of the alternative chain proposed, compared to the current situation, and identify the conditions under which the demand for the new integrated transport service can be expressed. Obviously, a multitude of data types and results are extracted from the Stated Preference survey.

The organizational scheme used to realize the customer survey is the following:

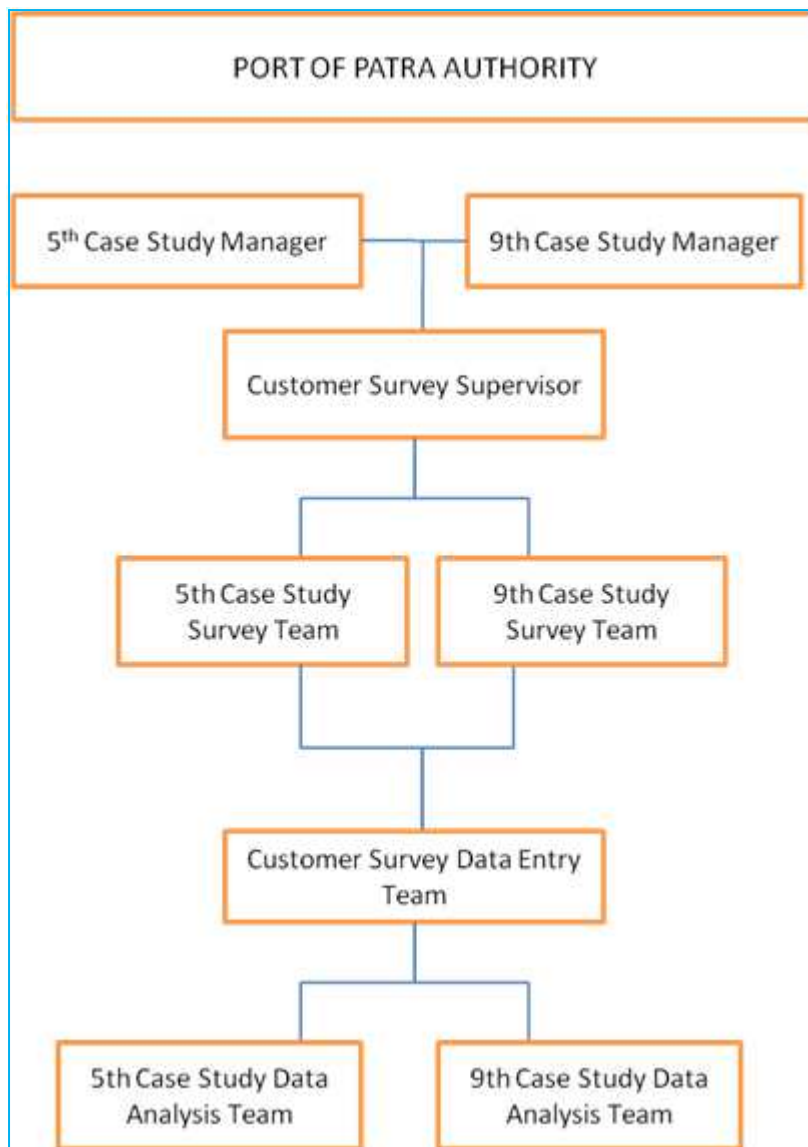


Figure 6.571 Co-operation with case study Port of Patras

The Case Study Manager contacted the Patras Port Authority and had many meetings and discussions with the port administration. The meetings focused on the investigation of main problems of the port regarding interconnectivity issues, services and perspectives for the development of the proposed integrated corridor. The Case Study Managers finalized the scope of the case studies in close cooperation.

The survey Supervisor was the coordinator of interviewers and the main responsible for the survey execution on the field. He supervised the whole procedure on the field. He was in permanent contact with the Case Study managers and the Patras port authority as well, giving solutions to any practical problem occurred during the survey.

The survey team was composed by 10 interviewers who worked during a period of five days in the port of Patras and the wider area (urban and inter-urban bus station, railway station). The 10 interviewers recruited are mainly students. Four of them are postgraduate students of the MSc “Shipping, Transport and Trade” of the University of the Aegean.

6.10.2.3 Stakeholder interviews

Interviews with some of the stakeholders of the current and the proposed situation took place complementary to the passenger survey. Stakeholders interviewed were the Commercial Chamber of Messinia, Trainose S.A (the company responsible for passenger and freight railway transport in Greece), a shipping line operating the Adriatic-Italian corridor and the Company of the Interurban buses connecting Patras to Athens (KTEL). Additionally, an interview was held with two members of the Board of Athens Public Transport Authority since Athens urban public transport is involved in the current business model (to ensure the connection between the Athens Railway station or the interurban bus station to the port of Piraeus (see the network configuration of the current “business” model).

The aim of the interviews was to identify the problems of the existing situation, to assess the feasibility of the proposed business model and to identify new opportunities, eventual barriers or conflicts of interest of most of the stakeholders regarding the future business model. The survey was based on an open interview covering all aspects of WP5. The results of the customer surveys were used and commented and the opinions of the stakeholders for the existing and the proposed situation were recorded.

6.10.3 Stakeholders/Agents at the site

The stakeholders at the site, which in our case as it was mentioned is a “corridor” (Patras – Piraeus- Crete) are the following:

The Port Authority of Patras.

The Mission of the Patras Port Authority is the development of the Patras Port as the West Gate of Greece towards Italy and the rest of European Union. Within this framework on the port thrives on:

- the exploitation of both the marine and land port areas assuring in this way the provision of competitive infrastructure and services at the port.
- the promotion of the principles of free competition in the frame of the relative European Legislation.
- the assurance of long-term viability and autonomy of the Port Organism
- the assurance of a good relation and cooperation with the local society

- the exploitation of its assets.

Interurban buses Company (KTEL of Achaia S.A)

The Central station of the interurban buses is located near to the port of Patras, 300 m from its central gate. The Company of KTEL Achaia S.A realises daily on average 100 itineraries in periods of medium demand, and considerably more in peak periods. It serves roughly 1.000.000 passengers annually.

The KTEL of Achaia covers one of the largest networks of corridors, on four basic axes: (1) Patras-Athens; (2) Patras –Thessalonica; (3) Patras-Kalamata and (4) Patras-Ioannina. It also operates a dense network inside the prefecture of Achaia as well as regular lines for the rest of the country.

Trainose S.A

The city's main Railway Station is in the port area. Trainose S.A is the company responsible for passenger and freight railway transport in Greece. The railway network in the Peloponnese Region is not developed and the railway service is degraded. The city of Patras is connected to Pyrgos and Kalamata with the old metric line and the connection to Athens is realised up to the city of Korinthos with buses of Trainose and continues with the suburban link Korinthos-Athens.

Port Authority of Piraeus

Piraeus, the largest port in Greece and one of the largest in the Mediterranean, is a lever of development of international trade, local and national economy.

The Piraeus Port Authority (PPA) currently employs more than 1,500 employees, serving per year more than 24,000 vessels, contributes to the development of local and national economy, and continues its growth by upgrading infrastructure and services. PPA is responsible for:

- Utilization for the land areas of the port
- Exploitation of the Organism assets

Port Authorities of Crete

Port Authority of Iraklio

The port of Iraklio is the main passenger gate of Crete.

The mission of the Port Authority of Iraklio is to:

- Become competitive, with services of high quality.
- Constitute the Cretan node of the modern transport chain.

- Constitute a transit - merchandising centre of Mediterranean.
- Become a pole of attraction by electing its historical sites.
- Be developed as tourist gate of Crete.
- Exploit its assets and its infrastructures.

Port Authority of Chania

The Port Authority of Chania has under its responsibility Chania Port, also known as Souda Port, which is located at the southern part of the Souda Bay and it is the second larger port in Crete, after Heraklion and the port of Kissamos a smaller port which serves only domestic ships and connects Crete with Peloponnese. The Port Authority of Chania aims to the development of the ports and its infrastructures.

Private passenger transport operator

In the port of Patras there are 7 private operators are activated realising international and national routes. The existing connections from the port of Patras are to Italy (Bari, Brindesi, Ancona, Venice, Trieste) and to ports of the Ionian Sea (Igoumenitsa, Kefalonia, Kerkira). All of the private operators are ferry companies.

In the port of Piraeus there are 5 private operators activated in realizing the route Piraeus – Crete (Iraklio, Chania). All of the private operators are ferry companies.

6.10.3.1 Objectives and Goals

All the above agents have their own objectives and goals with respect to their interests and business development. However, with respect to the described corridor Patra-Piraeus – Crete, they have no combined or competitive goals.

6.10.3.2 Strategies

All agents described have no specific strategies with respect to the under consideration corridor. Services are provided by each agent to the degree that passengers are related to them.

6.10.3.3 Interactions between agents

The lack of interactions between agents is illustrated in the table below.

Agents	Port of Patra	Interurban Bus	TRAINOSE	Port of Piraeus	Ports in Crete	Local Chambers of Commerce	Local Authorities	Region of (Peloponnese)
Port of Patras	X							In Collaboration
Interurban Bus		X						In Collaboration
TRAINOSE		No demonstratable competitive behaviour	X					
Port of Piraeus				X				
Ports in Crete				In collaboration	Potential for competitive behaviour			
Local Chambers of Commerce						Potential for competitive behaviour	In Collaboration	In Collaboration
Local Authorities							Potential for competitive behaviour	Region above local authorities
Region of (Peloponnese)								X

Figure 6.572 Interactions between agents

6.10.4 Current short-long interconnectivity problems/opportunities

As is mentioned, currently, passenger flows from the Adriatic corridor to Crete reach the final destination via the hub port of Piraeus. The identified barriers are mainly of functional and operational “service” character, since from the physical viewpoint infrastructural connections exist and, therefore, the necessary conditions are fulfilled.

The port of Patras, located in the north-west of the Peloponnese represents the western gate of the country. Naturally, it offers direct access to the entire Peloponnese Region. On the contrary, the maritime transport (ferry) services linking continental Greece (including the Peloponnese) to Crete are mainly based on the Piraeus hub port. There are already some established ferry lines between southern the Peloponnese and northern Crete. However, the service frequencies (once or twice per week) and quality are not satisfactory while the seasonal character of these flows creates wider problems of fleet optimization. Resulting from this “missing link”, the majority of passengers use the Piraeus port thus creating important trip deviations. The proposed case study examines the conditions for the successful creation of an alternative integrated intermodal passenger service from Adriatic-Ionian corridor to Crete through the Peloponnese.

In the current situation, ferry operations in the Adriatic–Ionian corridor are fully independent from the other legs of the chain. Ferry services from the Peloponnese to Crete are neither completely regular nor coordinated with Patras’ ferry services. In addition, any inland (bus or train) transport service from the port of Patras to the port of Kalamata (or, similarly, to Gytheion and Neapolis) is missing. Significant opportunities exist for the improvement and coordination of these connections. Ferry services in the Adriatic–Ionian corridor steadily present a high level of service; this is not the case for ferry operations between southern Peloponnese and Crete. There is considerable space for improvement of the latter, as well as to inland connections between the ports of Patras and Kalamata.

Another possible way to link continental Greece and, more concretely the port of Patras, to Crete would “theoretically” be to extend the maritime transport service from Patras to Crete. This link would have the theoretical advantage of continuity of the maritime service without modal shift for those passengers who come from Western Europe through the Adriatic corridor to Crete. However, this alternative is not realistic at all for the following reasons:

- Based on the results of the survey, only 3% of the total passenger traffic arriving at the port of Patras form through the Adriatic corridor has Crete as final destination. This limited demand will be considerably increased, estimated at least to double, in case of choosing the proposed corridor Patras- Kalamata- Crete due to additional demand from Peloponnese and the wider area of Western Greece to Crete.

- The ferries operating the Adriatic corridor between Italy and Patras are fast ships of considerably high capacity, high frequency of round trips and high productivity. Considering the previous consideration, the part of traffic continuing from Patras to Crete does not justify at all the use of such ships an extension of the journey; these fast ferries would lose considerable time for a non-rentable journey while they would create significant supply problems on their actual links.
- The only possibility would be a transshipment from ship to ship at the Patras port, in order to extend the maritime leg from Patras to Crete with more appropriate ships of reduced capacity and operating costs. However, the distance Patras- Crete is more than 300 miles and the long time trip (approximately 10h of additional travel time) make the connection non-competitive and non-profitable, compared to the use of the inland Patras-Kalamata alternative.

Therefore, it is obvious that these conditions do not really allow examining this alternative as a possible future business model, essentially considering that the advantage of the proposed model directly deals with travel time savings.

6.10.5 Current value proposition

Currently, the international Adriatic- Ionian corridor is linked with Crete through Piraeus port in the framework of independent intermodal services. Rail, bus, car and ferry services compose the chain of the offered services. Long and short distance services are combined to realize the connection between western European countries and one of the most important touristic regions in Greece, the island of Crete.

SERVICES	LEGS
Ferry Services	Piraeus- Crete
Rail Services	Patras – Piraeus
Bus services	Patras - Piraeus
Car services	Patras - Piraeus

Figure 6.573 Services

From previous chapters it is revealed that the main Gap for this case is the “Low level of service of current intermodal transport service”, according to WP2 classification and typology. Moreover, this corresponds to an extreme gap case since the current situation is based on successive independent mono-modal services on various legs of the corridor, neither coordinated to each other nor integrated.

6.10.6 Description of current business model

The Case Study titled “Extension of the Adriatic – Ionian corridor from Peloponnese to Crete” does not examine the improvement of the current business model which is applied in a single nodal location, but the improvement of one O/D service which currently is composed of different business models for each part of the service.

In the current situation, the service linking Adriatic corridor to Crete is composed of independent sub-services and each one applies a different business model. The proposed case study offers an alternative integrated intermodal passenger service from Adriatic corridor to Crete through Peloponnese.

Because of the specificity of the case relies on different segments for the improvement of one O/D service, following a brief description of the current business model will be presented.

According to Osterwalder (2004) there are nine building blocks Customer Segments (CS), Value Propositions (VP), Channels (CH), Customer Relationships (CR), Revenue Streams (R\$), Key Resources (KR), Key Activities (KA), Key Partnerships (KP) and Cost Structure (C\$). b

6.10.6.1 Customer Segments (CS)

The passengers using the corridor Patra- Piraeus – Crete are:

- 59% male and 41% female
- 47% between 36-55, 35% above 65 and the 12% between 21-35

The most common destination to Crete is the city of Chania and the start origin of the passengers is 36% from Italy, 20% from Switzerland, 19% from Germany and 7% from Austria.

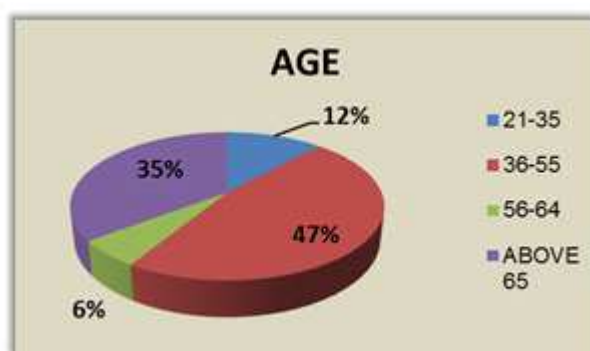


Figure 6.574 Age

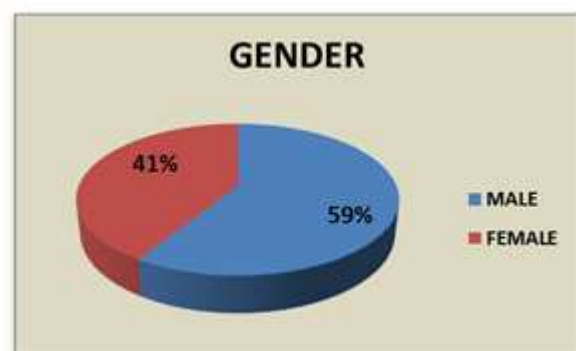


Figure 6.575 Gender

6.10.6.2 Value Proposition (VP)

In the current situation, transport services of various modes -not integrated- are offered along the examined corridor. The customers themselves proceed to various modal combinations in order to reach the final destination, but the transport service on each leg of the chain is fully independent from each other. Rail, bus and car services are offered on short distance as well as on long distance, depending on the leg of the chain.

The service level of most of the transport operations realized in the corridor is satisfactory. Ferry services in the Adriatic – Ionian corridor and in the leg Piraeus – Crete present a high level of service as also the short distance rail and the long distance bus services. The satisfaction for the punctuality of the transport offer exceeds the 70% and reliability remains in the same level while the offered infrastructure for the disabled people is satisfied in ferry services and in short distance rail service.

6.10.6.3 Channels (CH)

Besides the travel agents and the tour operators cooperating with the transport operators of the examined corridor, the transport companies use the Internet services to deliver their service offering. Through Internet they offer a safe on – line booking system. As all the services of the corridor are not integrated and each one is fully independent from the others there are separate websites of each transport operator of each service.

An important channel to communicate with the passengers is the advertising through media especially during the summer months. Potential users are easily informed about the seasonal offers as well as about additional benefits.

6.10.6.4 Customer Relationships (CR)

Each transport service of the examined corridor has its own customer service relationship plan.

Ferry Services

Ferry services have rewards programs for frequent travellers which offer benefits in the form of discounts, participation in promotions and special offers. The passengers participating in such programs collect points from the purchased tickets.

Also they have several discount programs for passengers 13 to 25 years old who are entitled to a 20% discount . At the ports of the corridor information desks of all the ferry transport operators are located and dedicated employees to sell tickets.

Rail services

The Rail long distance services offers discount programs for youth passengers as also for elderly people but fidelity programs are not in the customer service relationship plan. Information desks are located in the area of the railway stations and the ticketing sale is realised by employees.

The Rail short distance services offers special prices for the commuters, young passengers and elderly people and the ticketing sales are made either by machines or employees in the area of the station.

Car services

Offices of rental cars at the nodes of the corridor have located information desks and offer special packages depending on the ferry transport operator they cooperate with.

Bus services

Bus services do not offer fidelity or other rewards programs to the frequent passengers. The customer relationship plan includes information desks and the ticketing disposal made by employees in the area of the bus station.

6.10.6.5 Revenue Streams (R\$)

The main income for the transport operators involved in the current situation results from tickets. Advertisement on the means of each transport operator and sub- contracted services on board for ferry operators constitute another revenue source.

6.10.6.6 Key Resources (KR)

Taking into account the specificity of this Case and more concretely the facts that

- a) the case spatially refers to a corridor and not to a single nodal interchange pole,
- b) there is not a company as “central” actor or reference in the current situation
- c) there is not really a business model as such but a set of independent services offered to customers, who compose their chain configuration (itineraries and services to combine themselves) and

- c) the future business model relates to an alternative corridor,

a description of Key Resources for the current business model is not really appropriate. Any approach of Key Resources of each operator involved falls into the analysis of typical “monomodal” public transport service (either urban or inter-urban).

6.10.6.7 Key Activities (KA)

Same as in previous chapters.

6.10.6.8 Key Partnerships (KP)

Same as in previous chapters.

The operators involved are either complementary or competitors. For example, complementarity is developed between shipping lines (on the maritime legs) and inland transport services. On the contrary, TRAINOSE S.A and interurban bus services are competitors on the inland leg between Patras and Athens/Piraeus.

In all cases, as already mentioned, the operators involved have not established official partnerships between them, based on official agreements (excepting the shipping lines with the port Authorities involved). TRAINOSE S.A and interurban buses organise their timetables independently to each other, on the basis of the whole transport demand; the traffic flows of the examined corridor represent just small part of this demand. Due to the relatively high frequency of respective services, customers can combine modes and services by their own.

6.10.6.9 Cost Structure (C\$)

Same as in previous chapters.

The topic falls into the analysis of typical “monomodal” public transport service (either urban or inter-urban).

6.10.7 Current level of quality of services and customer satisfaction

6.10.7.1 Description general information about the passenger

In this part of the questionnaire information about the origin, the destination, the purpose and the duration of the trip are collected as well as the composition in which the participants are travelling.

As it is presented in the following figures, the origin of the transfer in percentage of 35% emanates from Attica and Sterea Hellas. Attica appears to be the basic feeder of the passenger traffic. For the percentage of the passengers that declares as origin the port of Patras, 21%, there is an important uncertainty as for the validity of answer.

As most common destination, 36% is Italy while the corridor Italy - Austria Germany assembles the 48%. It is marked that an important share of the transfers corresponds also to the Ionian Islands.

Furthermore, the main trip purpose is vacation and this is the reason why the duration of the whole trip for the most of the participants lasts up to 10 days and for more than 50% lasts up to 15 days. But we must mention also that the percentage of the people travelling for business is high 24%, and most of them have a European destination (Germany, Italy, Spain).

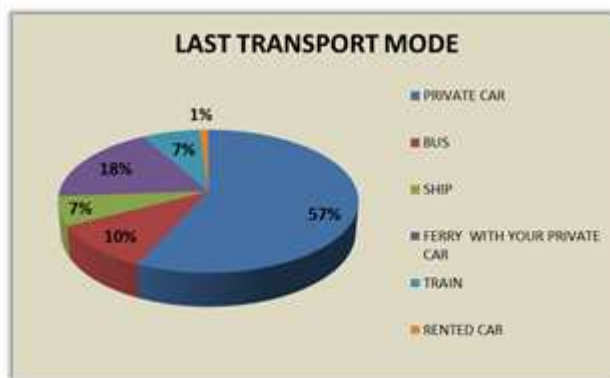


Figure 6.576- Last transport mode

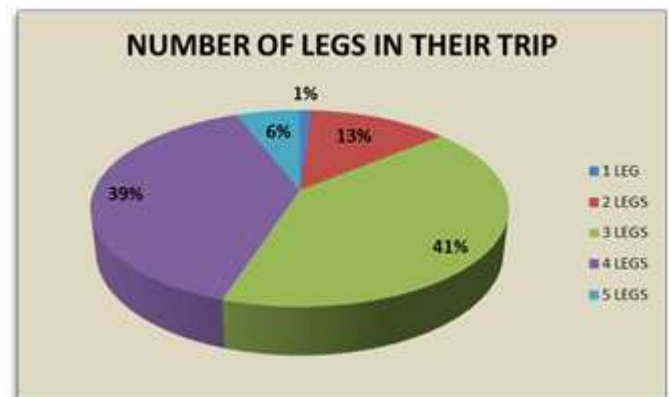


Figure 6.577- Number of legs



Figure 6.578- Start Origin



Figure 6.579 - Final Destination

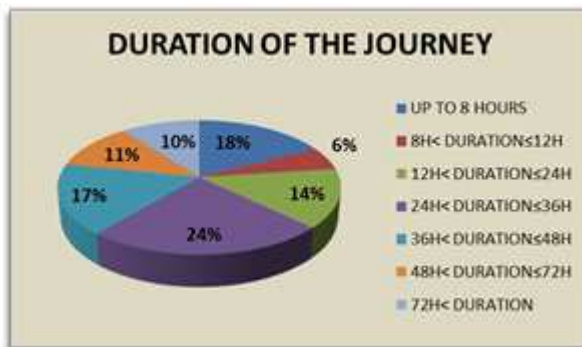


Figure 6.580- Duration of the journey

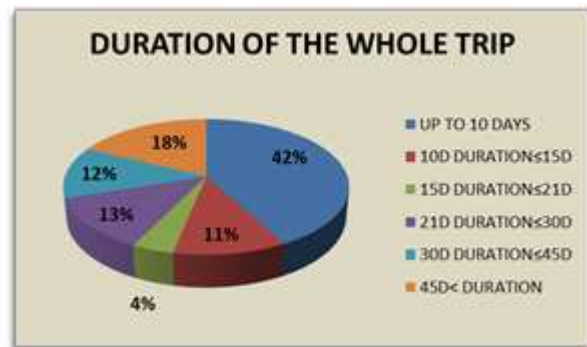


Figure 6.581- Duration of the whole trip

6.10.7.2 Travel demand/Passenger flow

Due to specificity of the case is defined by examining the

Transport demand of the port of Patras, the touristic flow to Crete and the number of passengers estimated using the corridor.

a. Transport demand for the port of Patras

The overall international flows of Passengers, Trucks and Vehicles of the port of Patras for the period 1999 – 2009 is presented in the following table and figure. According to this data, almost half of the country's overall sea passengers' traffic to / from foreign destinations is carried out by the Port of Patras.

	PASSENGERS	TRUCKS	VEHICLES
1999	1.106.293	284.030	217.297
2000	1.275.987	292.661	251.242
2001	1.315.019	280.689	248.309
2002	1.355.350	296.964	255.626
2003	1.263.124	304.979	249.345
2004	1.125.159	298.833	222.486
2005	1.247.991	283.778	226.269
2006	1.264.274	295.206	216.186
2007	1.130.880	296.900	211.864
2008	1.094.450	312.459	198.626
2009	981.288	251.429	171.698

Figure 6.582 International flows

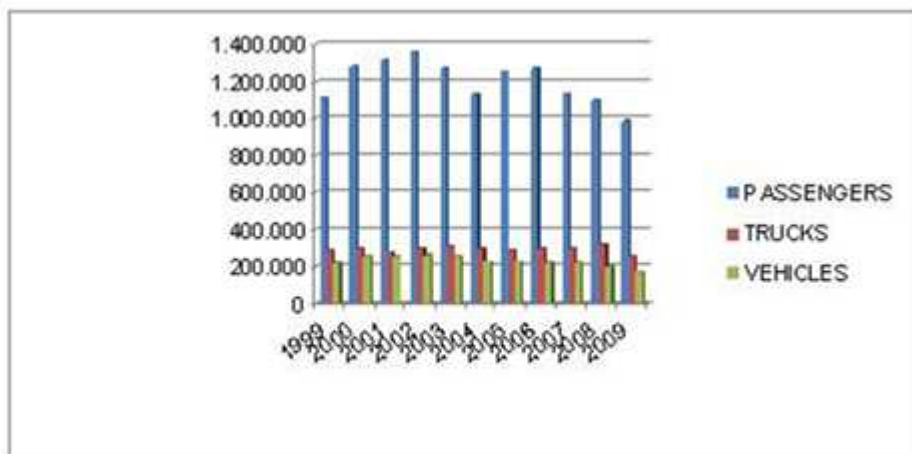


Figure 6.583 International flows

As it is presented almost 1,0 million passengers are travelling from/to the port every year. There is a small decrease in the passengers flow the last eight years while in the same time there is an increase in the trucks flows. The limited accommodation capability of the current Port and the construction of the Egnatia Motorway which improved the accessibility of other competitive ports, may constitute some reasons for this decrease.

Number of tourists	3.200.000
Transferred by plain	2.750.000
Transferred by ship/ferry	450.000

Figure 6.584 Data for the tourism in Crete (2007)

b. Number of passengers using the examined corridor

The customer survey showed that the 3% of the passengers at the port of Patras have used the corridor Patras – Piraeus – Crete. Based on the data of the touristic flow of the island 16.000 passengers have used the examined corridor.

6.10.7.3 Time

The time data collected during the customer survey concerns the transfer time at the terminal/interchange and the waiting time until the next departure. Also information about the maximum acceptable time to spend at the terminal and to walk at the terminal was received as it is shown in the following figures. These reflects the passengers' needs for the other also nodes of the examined corridor. Time is very essential factor for the quality of transport services and especially in the examined corridor of almost 530 km becomes crucial where the total waiting time varies between 4 to 6,5 hours and the travel time for the passenger flow coming from the Adriatic- Ionian corridor exceeds the 30 hours.

6.10.7.3.1 Time descriptive data

The transfer time at the terminal/interchange is in high level as we see that the 52% of the passengers participated in the survey have been transferred in the area of the port in at maximum 5 minutes. Percentage that grows to 76% for transfer in 10 min (Fig 5.8). The transfer time exceeds the limit of "dissatisfaction" of the 20 minutes in a percentage 12%. The percentage is satisfactory and implies the satisfactory level of exploitation of the port infrastructure, the cooperating transport modes and the organization of the port operation.

The waiting time until the next departure imply undeniably that the frequencies of the itineraries are satisfactory.



Figure 6.585- Waiting time

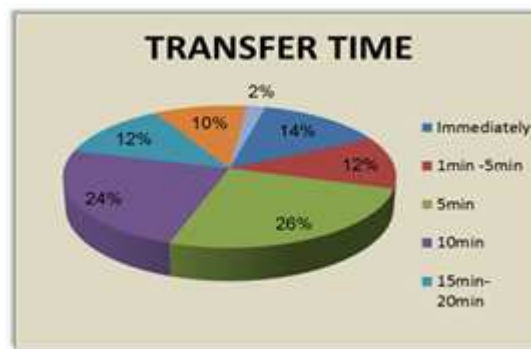


Figure 6.586- Transfer time

46% of the participants believe that the acceptable time to spend at the terminal/interchange is up to 30 min. Comparing the results of the figures above seem that in general the passengers are satisfied with their stay at the port of Patras since the waiting time until their next departure is in the acceptable limit and only a small percentage of 16% is probably disappointed.

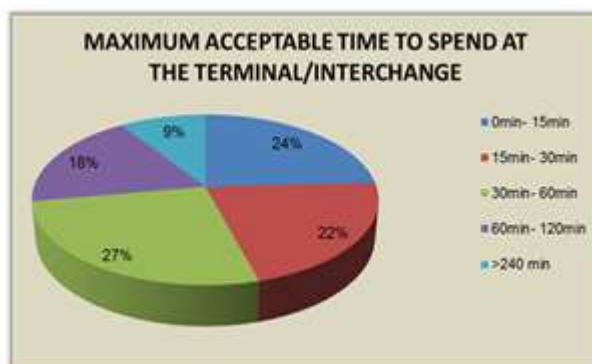


Figure 6.587 - Max acceptable time to spend at the terminal

6.10.7.4 Space

Concerning the space and the distances in the port of Patras the data resulted from the customer survey show the satisfaction of the passengers.

The 62% of passengers that walked at the port needed no more than 5 min to arrive to the embarkation point while this walking time is considered as the max acceptable by the 12% of the participants.

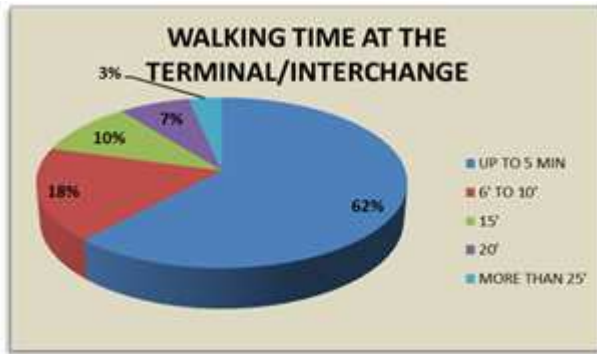


Figure 6.588 – Walking time

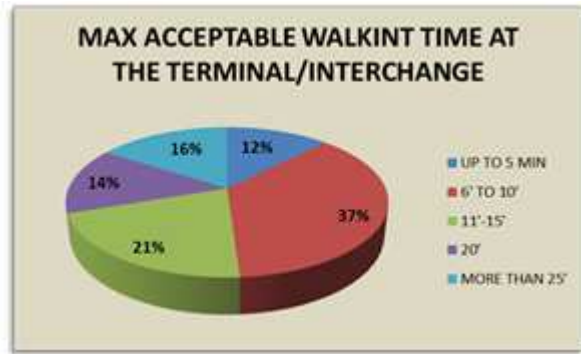


Figure 6.589 – Max acceptable walking time

Concerning the importance of each service/facility, as very important the 65% of the passengers selected the signposting and the facilities for the disabled people. The impressive point is that even if at the rating of the quality of the existing Facilities for disabled people the 38% of the participants did not answer, in the rating of the importance the 97% of the passengers rated the Facilities for disabled as very important. It indicates the sensibility of the public on this issue.

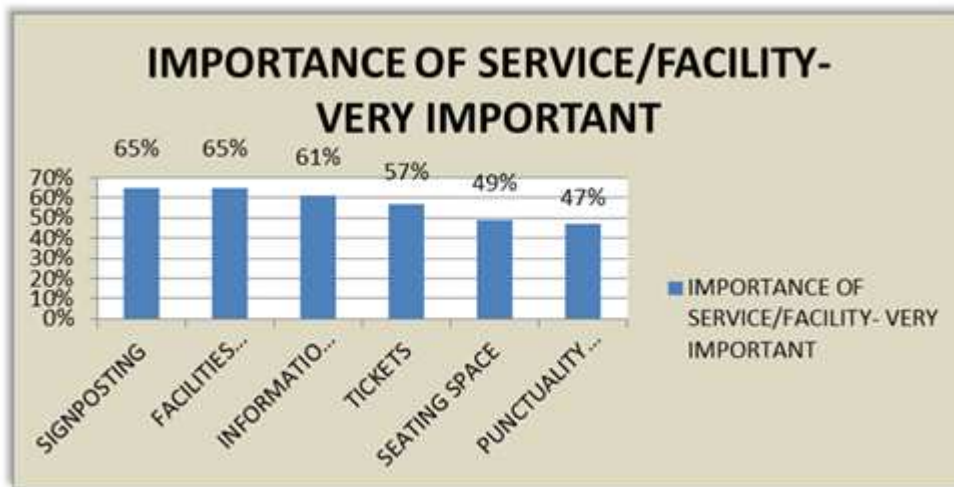


Figure 6.590 – Importance of service/facility, very important

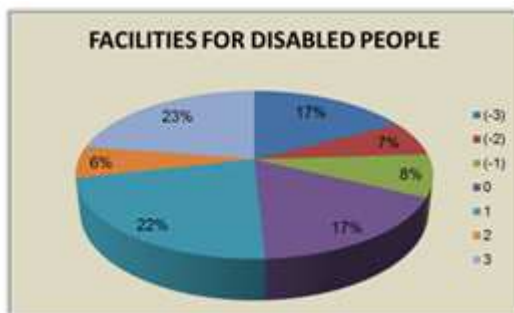


Figure 6.591– Facilities for disabled people

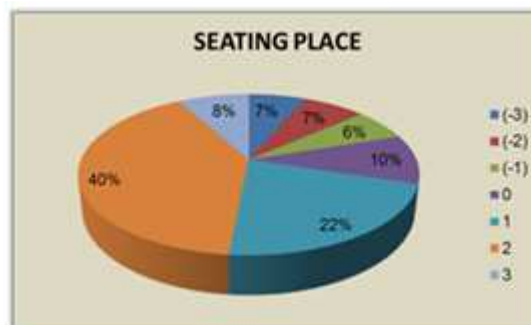


Figure 6.592– Seating place



Figure 6.593 – Shops

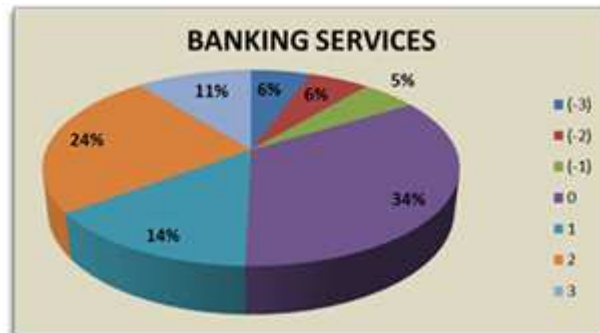


Figure 6.594 – Banking Services

6.10.7.5 Information, Ticketing and Check-in Services

The participants in the survey rated the quality of the services and facilities of the terminal/interchange concerning Information and Traveling and Travel Services. With the exception of the signposting, the level of the provided services, operations and the total organization of processes that is related with the port's operation is appeared to be marked satisfactorily from the users.

In the first category, the passenger percentage which mark the information displays satisfactory exceeds the 60%. The percentage that expresses satisfaction for the functionalism of the sign posting is judged low. The signposting in the port area constitutes an important parameter for the passenger facilitation and it is connected with the interchange time and the 40% of the passenger are not satisfied with the signposting.

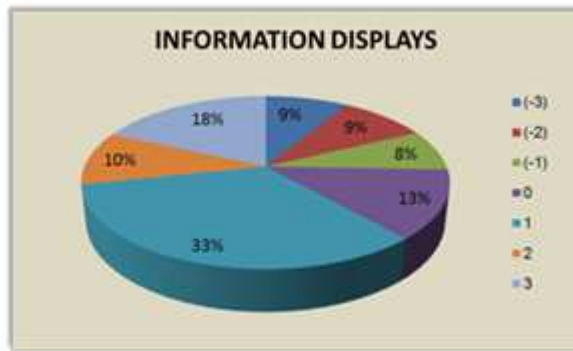


Figure 6.595- Information displays

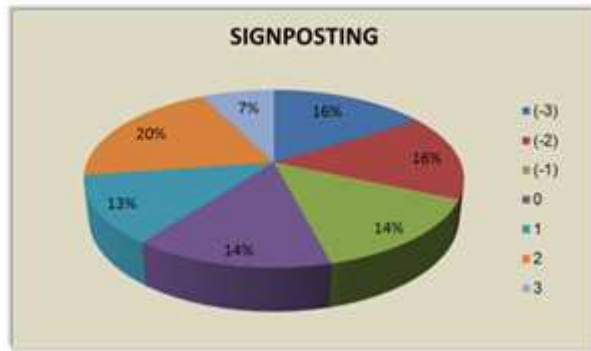


Figure 6.596 -Signposting

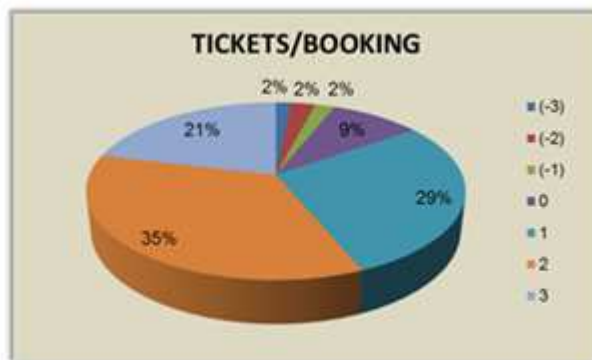


Figure 6.597- Tickets- Booking



Figure 6.598-Luggage handling

Concerning the Ticketing and the Check -in Services in the current situation there is no integrated system. For each part of the corridor there is an independent service of ticketing and Check -in and there is no cooperation and coordination between the different actors involved. Even if the passengers are satisfied with the offered service of Ticketing/Booking in the different parts of the corridor, this situation increase the interchange time and the total travel time.

6.10.8 Analysis for improvement of interconnectivity

6.10.8.1 Comparison between customers and stakeholders

Taking into account the specificities of this Case and more specifically the fact that customers evaluate the whole chain from the Adriatic (matitime) corridor to Patras – Piraeus-Crete while stakeholders' (operators') views and interests are limited to a particular leg of the chain, any comparison between customers' and stakeholders' views regarding the current situation is inappropriate. In addition, passenger flows served by each operator include various market segments (national transport, regional transport, international transport with various Greek destinations) of which only a part represents the flows examined by the case study (passengers having Crete as final origin or destination). This approach is appropriate and meaningful as far as the future proposed model is concerned.

6.10.8.2 Validation of findings in WP3/WP4

For the aforementioned reasons, this validation takes place when the future business model is analyzed.

6.10.8.3 Missing links and new Value Proposition

Currently, the maritime transport (ferry) services linking continental Greece, including the Peloponnese, to Crete are mainly based on the Pireaus hub port. Case Study 5 deals with "accessibility" barriers between various network components of the aforementioned corridor. These barriers are mainly of functional and operational "service" character, since from the physical viewpoint infrastructural connections exist and, therefore, the necessary conditions are fulfilled. The proposed Case Study offers an alternative –optimised- network service solution for connecting the Adriatic corridor to Crete. The aim of the study is to integrate the currently "missing link" i.e between Patras and Southern Peloponnese to the network.

The alternative service integration proposed by this Case Study aims at fulfilling the following conditions:

- Improvement of medium distance ferry service (Peloponnese-Crete)
- Coordination of both maritime transport services involved
- Creation of a "shuttle" inland transport service (either bus or rail) connecting port of Patras to the port of Kalamata in southern Peloponnese

In addition, the aim is to provide direct access from port to port, one ticket for the whole chain (either for public transport or private cars), luggage services at the port of Patras and integrated-inter-related schedules of the transport services involved.

As already mentioned it is revealed that the main Gap for this Case is related to “links” and more particularly concerns the “Low level of service of current intermodal transport service”, according to WP2 classification and typology. Moreover, this correspond to an extreme gap case since the current situation is based on successive independent monomodal services on various legs of the corridor, neither coordinated to each other nor integrated. Consequently, the new Value Proposition for this Case falls into the Business Model Category concerning the upgrade/development of services at the level of transport links and directly deals with Intermodal Transport Services.

6.10.9 Actions for improvement of interconnectivity

6.10.9.1 Proposal

The proposal of this Case Study deals with the development of a fully integrated intermodal transport service for passengers between Western/Central Europe through Italy and the Adriatic-Ionian corridor and Crete, avoiding deviation through Piraeus. The study examines the entire network configuration of such an integrated service, including: a) the long distance ferry transport between Italy and the port of Patras; b) the inland leg connecting the port of Patras to the southern Peloponnese and c) the medium distance ferry transport from southern Peloponnese to Crete. However the main focus of the study is on the currently “missing link” i.e. the inland leg between Patras and Southern Peloponnese which needs to be integrated into the network.

In the current situation, the maritime transport (ferry) services linking continental Greece - including Peloponnese- to Crete are mainly based in the Piraeus hub port; passenger flows coming from the Adriatic corridor and having Crete as final destination, are oriented from the port of Patras to the port of Piraeus through the road transport network (private cars or bus services) and then, they use ferry services to Crete.

Considering the passengers and the transport market, the expected added value of the proposed service and business model relates to:

- Service improvement: travel time reduction, transport cost reduction
- Service enlargement and additional benefits for users: integrated package including transport and touristic services (accommodation, cultural activities etc)

In addition, beyond the users' benefits, the proposed model is expected to create numerous socio-economic benefits, such as:

- Reduction of the total vehicle-km produced
- Alleviation of congested road corridors and terminals
- Promotion of new Short Sea services

And more generally,

- More environmental friendly solutions
- Integration of -previously independent- maritime services
- Synergies between passenger and freight transport
- New dynamics for Short Sea Shipping

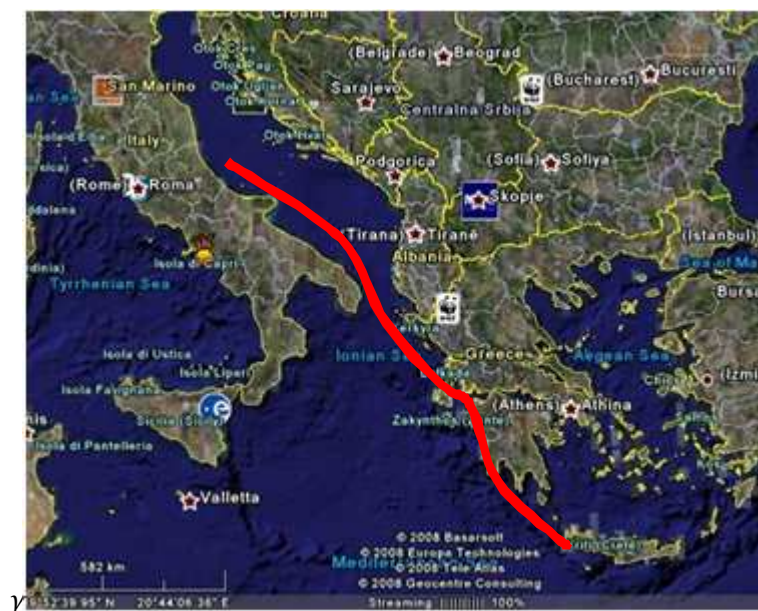
6.10.9.2 Description of new business model

6.10.9.2.1 Service offering

The proposed case study examines the conditions for the successful creation of an alternative integrated intermodal passenger service from Adriatic- Ionian corridor to Crete through the Peloponnese. Based on this, the proposed business model is related to new touristic services. The Service Offering consist of two packages: the “direct transport to Crete” (for Non- Stop Travellers) and the “Transport and Tourism” package.

The package for the Non-Stop Travellers offers the direct access from an Italian Adriatic port to Crete through the ports of Patra and Kalamata. This service will cover the missing link that exists today, the connection of the Peloponnese with Crete, and will offer a direct transfer avoiding the port of Piraeus and minimizing the trip deviations. It gives the opportunity to the tourist to realize the whole trip with one ticket and to have the less possible attending time at the interchanges due to integrated schedules that the new service will provide. This service consists of the following parts:

- Transfer from Italy (Ancona, Brindisi or Venice) to Greece (port of Patra).
- Transfer with a shuttle inland transport service (bus or rail) to the port of Kalamata in southern Peloponnese.
- Transfer to Crete (Chania) by ship.



 **Standard Package**

The suggested services of the package assembled in following: Transportation, luggage handling, e-ticketing,

The Transport and Tourism package combines the transfer from an Italian port to Crete with a two days sightseeing tour in the Peloponnese. This package includes transportation, accommodation and sightseeing tour. With one ticket for the whole chain the tourist receives:

- Transfer from Italy (Ancona, Brindisi or Venice) to Greece (port of Patra).
- Two days' stay (one night) in Peloponnese and visit of the most important archaeological sites.
- Transfer to Crete (Chania) through the port of Kalamata.

6.10.9.2.2 Customer Segments (CS)

Following the customer segmentation presented with regard to potential users of the proposed new integrated chain from the Adriatic corridor to Crete through an inland connection between the ports of Patras and Kalamata with the use of discrete choice modelling. More specifically, customer segments are identified based on a combination of criteria and characteristics that were used as explanatory variables in a route and mode choice model.

The figure below presents the modelling framework for the mode/route choice of travellers for the proposed extended Adriatic-Ionian Corridor from the Peloponnese to Crete with an ultimate goal to identify different market segments. The attributes that is expected to influence travellers' decision-making process for a journey to Crete through the Adriatic-Ionian corridor can be broadly categorized into the following four groups:

- Individual's characteristics and experience, such as age, gender, income, profession, etc. Users' experience influences behaviour since it constitutes the major database that is registered in their memory. Experience is measured by the frequency of use of the alternative transport modes/ routes in the past.
- Alternative transport mode and route characteristics, such as travel time, number of transfers, travel cost, etc.
- Trip characteristics, such as trip purpose including work, vacation, etc., number of individuals that travel together, etc.
- Information with regards alternative transport modes and routes. It involves information that users receive by sources such as friends, family, or co-workers. This information has a great impact, especially in the case of passengers that have never travelled to the particular destination. It is based on the opinions acquaintances have for certain alternative modes/routes and their corresponding characteristics.

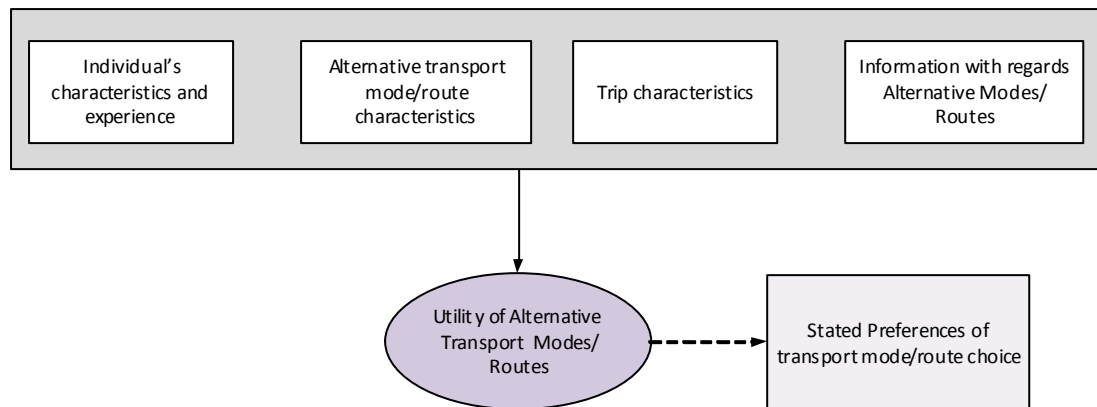


Figure 6.599: Modelling Framework – Customer Segmentation Process

6.10.9.2.3 Data Collection Methodology

The data collection methodology involved personal interviews addressed to travelers of the Adriatic Corridor. These interviews took place at the port of Patra. The choice of the interviewees was random. The questionnaires included two parts. A revealed preferences part that indicated the actual individuals' preferences and choices, and a stated preference part in which information about the trade-offs between the alternative modes and routes characteristics were provided in hypothetical scenarios.

For the modeling effort presented below, a total of 169 complete questionnaires collected in September 2010 were used, where the trip purpose of the respondents was vacation. These questionnaires provided a total of 623 stated preferences data that were used for the estimations of discrete choice models.

6.10.9.2.4 Questionnaire Development

The questionnaire developed was supported by the passengers' modeling framework presented in the previous section. The questionnaire collected the following information:

- **Revealed preferences data**, which included: (a) general travel information (origin-destination, travel in group or not, trip purpose, whole trip duration etc); (b) information concerning modal choice of customers, decomposing the whole trip of passengers into legs; (c) information at the Interchange level, such as services offered at the interchange, customers evaluation of the performance of the services offered and rating of the importance of each type of service; (d) Alternative Routes, not selected by the customers

for reaching their destination and focuses on the criteria of their choice (cost, travel time, comfort, quality of service at the means, quality performance of the interchange used etc).

- **Socio-economic characteristics**, such as age, income, gender, nationality, etc.
- **Stated preferences data**, representing passengers' responses to various hypothetical scenarios in which travel time and travel cost varied. The Stated Preference experiments will contribute to the assessment of the attractiveness of the proposed business model.

6.10.9.2.5 Results from the Descriptive Analysis

The results of the descriptive analysis of the data that were used in the model development process are summarised as follows:

- Approximately 10% of the respondents are less than 20 years old, while 7% gain more than 2.000€/month.
- 11% of travellers have their children travelling with them.
- 36% of travellers made more than 4 stops (transfers) during their trip to/from Patra.
- More than half of the respondents (52.2%) travel by car and approximately 11% travel by bus during the inland part of their trip.
- One third of the respondents (29,8%) planned their trip from 3 to 18 months ago, while 20% planned it only within a few days (1 to 20 days).

6.10.9.2.6 Customer Segmentation – Model Specification and Estimation Results

Based on a priori assumptions, as well as on the descriptive analysis of the data, it was decided to segment the sample based on the number of stops variable. Thus two market segments were created as follows:

1. **Non-Stop Travellers:** all the individuals that conducted less than/equal to three stops during their reported journey; and
2. **Travellers with Stops:** all the individuals that conducted more than 3 stops during their reported journey.

In order to verify that systematic variation of the coefficients in the above subgroups of the sample exists, a model comparison took place. To do so, a model with the full data set was first estimated and then the same model was estimated for each segment separately. The values of the market segmentation test and the likelihood ratio test (Appendix A) revealed that indeed

6.10.9.2.7 Customer Segments Additional Characteristics and Market Share

- Non-Stop Travellers: Travellers' that are young (under 20 years old) and/or have high incomes and prefer to use mass modes either bus or rail ; Travellers that plan their trip well in advance and prefer to use their own car. These travellers are interested for a direct trip from Patra to Kalamata, with no intermediate stops and corresponds to 64% of the target population;
- Travellers with Stops: Travellers' that are in favour of multiple stop trips but they want to use their car, such as those that travel with children and/or have high incomes; Travellers that like to plan their trip well ahead and use mass transit modes for their multiple stops journeys. These travellers are interested for a multiple-stop trip from Patra to Kalamata, and corresponds to 36% of the target population;

The above preliminary customer segmentation will form the base for offering better tailored services to the potential customers of the proposed extended corridor.

6.10.9.2.8 Value Proposition (VP)

The alternative service integration proposed by this Case Study aims at fulfilling the following conditions:

- Create an and integrated intermodal passenger service
- Improvement of medium distance ferry service (Peloponnese-Crete)
- Coordination of both maritime transport services involved
- Creation of a "shuttle" inland transport service (either bus or rail) connecting port of Patras to the port of Kalamata in southern Peloponnese

In addition, the aim is to provide direct access from port to port, one ticket for the whole chain (either for public transport or private cars), luggage services at the port of Patras and integrated-inter-related schedules of the transport services involved.

The proposed business model consists in a bundle of new products and transport services that relate to "newness", "performance" of the transport system, "accessibility", "cost reduction" and time savings, according to Osterwalder Business model analysis. It is also related to possible new touristic services (marvellous sightseeing in Peloponnese, visit of famous sites such as ancient Olympia, middle age castles in southern Peloponnese etc).

6.10.9.2.9 Channels (CH)

The 3rd Party Provider (the entity) assumed to operate the proposed business model on the corridor Adriatic Sea – Patras –Kalamata - Crete will have two main channel categories for reaching its customer segments:

- The “direct” -mainly electronic- channel, through the use of the Internet websites of stakeholders directly involved in the proposed business model (Port authorities, shipping lines, transport operators, local and regional authorities, chambers of commerce etc.). This channel covers the need of purchase, delivery and the reception of real- time information.
- The indirect channels, notably travel agents or tour operators involved as “intermediary” customers, as well as information desks of local authorities and other interested institutions (e.g. cultural institutions and users associations) which will be members of the partnership.

In the frame of this block of the business model, the results of the customer survey, as well as the interviews with the stakeholders potentially involved, will allow assessing the need and the capability of further development of the above channels.

6.10.9.2.10 Customer Relationships (CR)

The objectives of the new integrated chain proposed is to upgrade the quality of services and automate them as far possible. Using the mentioned channels, the customer relationships will be leaded in a more personalized and reliable frame.

6.10.9.2.11 Revenue Streams (R\$)

The revenue sources of the proposed integrated transport service are the tickets per destination, the services related to touristic activities (museums, archaeological areas, other touristic sights etc) and provided services at the level of interchange.

6.10.9.2.12 Key Resources (KR)

Resources to be committed by the transport operators include:

- Physical (vehicles, vessels, customer support centers, terminals)
- Human
 - on-board personnel
 - office stuff including management and helpdesk
- Financial (investment for upgrading transport means and infrastructure)

Assets required by the 3rd party provider:

- The Human resources of the 3rd party provider will include the following critical posts

- Manager. Responsible for managing all the services that affect the customer using this multimodal service. He will manage the planning, delivery and organization of passenger services: ticketing, dealing with complaints, getting service level right to deal with unpredictable crises, ensure the safety and security of the services.
- Administrator. Administrator's role is very specialized. He plans, organize and control the operational activities of the proposed business model. He will coordinate the related staff from the different parties (ship companies, bus and rail operator, tour agencies etc) and approve the procedures for the passenger services. He will also approve the rates, where these are not controlled by government agencies and transport and touristic associations, and develop the operating policy.
- Technical Support. Technical Support is an essential need and with a strong team, the issues of hardware or software problems can be easily solved.
- Helpdesk. Vital part of the providing service. It is the central point through which problems are reported and managed. Provide support to staff on all supported services. Troubleshoot computer problems and advise on appropriate action. Regular problems can be dealt with by a knowledge base. Further, with help desk software other problems can be handled more efficiently. Equipped with a good help desk software package is also good management practice for the feedback it provides into areas where there is scope for improvement.
- Operators
 - Financial (investment for the development of upstream interfaces and, if necessary, for increasing platform capacity)

6.10.9.2.13 Key Activities (KA)

The required Key Activities in the business model of this Case can be separated in two sectors. The Key activities realized by a 3rd Party Provider and the ones realized by the transport operators.

Concerning the 3rd Party Provider, the Key activities are related to the management and the monitoring of the service offering.

- Implementation of a Platform in order to manage and to monitor all the services, transportation, booking, payment, accommodation, marketing, publishing, coordination of the different operators. Service provisioning. The appropriate platform provides the benefit of fully integration of different transports and technologies that the transport

operators will probably use and the possibility to start with some services and then add more.

- Implementation of a system of repair services in order to solve any kind of problem in case of a system failure.

Concerning the transport operators' key activities:

- To ensure the provision of transport and the high level of handling services. Provision of an accurate, reliable, transport service with integrated schedules of the transport services involved. The handling services make an essential contribution to the efficient use of the offering transport services.
- To offer an upgraded booking system which will provide real time online reservations, secure online purchasing system, the opportunity to select, book and buy tickets directly by the travel agencies, at the involved ports, from desks of the Local Authorities in Greece and with the help of the Ministry of the Greek Tourist at desks in the European Cities. A crucial point is the cooperation of the European and Greek travel agencies in order to achieve also the integration of tourist activities in the transport work.
- The customer support before during and after the trip is critical. An individual service of customer service must be organized in the frame of the new service. Providing high level of Customer support improves the whole operating level of the proposed service. In this sector must provide:
 - Customer service training to educate every employee who has direct contact with consumers. Emphasize the importance of a high standard of service. At any customer contact, employees must recognize customer service as a priority. Ticketing agents, bus drivers and commuter rail operators must maintain a friendly and helpful behavior toward customers.
 - Implement software and support technology to help and enable the employees to provide a higher level of customer service. Customer Relationship Management (CRM) software will allow to enter, access and track customer activity and information.
- The implementation of a contingency plan is an additional key activity for the successful application of the model. Co-ordination between the different transport operators (ship, bus, Rail) and a reliable contingency plan are important if either of their services is disrupted. The scope of the plan is to achieve a better co-ordination among various transport modes and reducing wasteful competitions in case the continuity of services is threaten. It must be marked that people are not familiar with alternative means to their destinations when there is a disruption, especially during their vacations. Travel behavior and reactions of the passengers when there is a disruption are critical for the effectiveness of the contingency plans and an effective information system could reduce

further negative impacts on the disruptions. A contingency plans for unanticipated situations that may arise is will be based on three points:

- Identify and confirm transport demand
- Arrange alternative transport
- Monitor and update transport arrangements

6.10.9.2.14 Key Partnerships (KP)

Generally, the business model of this case study is based on partnerships between the transport operators, the travel agencies, the port authorities, local authorities, Chambers of Commerce etc.. The combined efforts of the parties may provide the service described. However, in this respect there are two basic issues to address:

- (1) Which of the above entities could initiate the service offer and act as the service promoter?
- (2) What the structure of the generally described "3rd party provider" should be?

As previously described, the agents presented at the "site" even in the case of the existing case (i.e. the corridor Patra- Piraeus – Crete) have no interaction. In the new case offering the potential for new services and potentially new activities /revenues may develop challenges as these agents have no previous collaboration experience. In addition, while their basic service is the provision of transport services and development (local authorities and chambers) the proposed offering is outside the core business operation of all agents.

This leads to the need to partner in order to out-source the activity and "develop" and new entity dedicated to provide the described service.

As the proposed structure should integrate all the services into a single service bundle, it would initially seem appropriate to create this 3rd party provider-entity, which would be required to operate in a competitive market on private entity terms (tourist offering/services) in collaboration with private transport operators (shipping lines, bus operators, hoteliers, tour guides etc.) but also in close collaboration with public authorities (port authority of Patra and Kalamata, Prefecture/Municipality of Achaia, Helia, Messenia and Crete, Chambers of Commerce, Archaeological Services & Museums etc.). In essence, this 3rd party provider –entity is described as a pure public & private partnership.

The next issue, as presented above, is, who the initiator of this activity might be. Central government bodies dedicated to tourism and regional development or even transport might be on this list. However, as the further away the government institutions are to the offering the

more complexity is brought into the issue as more conflicting interests may evolve or the need to pursue the service offering might be less immediate. Containing it at a very local level, i.e. local authorities may be equally unproductive as no prefecture (which is the highest level of local authority) has the overall responsibility of the region. Following this line of thought, the most appropriate authority to lead the effort and set the standards that might be needed or even provide support for initiating efforts is the Regional Authority of Western Greece-Peloponnese & Ionian Islands. This authority has the legal and authoritative competence to lead the effort.

The Regional Authority may guide and provide the respective power to the “3rd Party provider” to coordinate all the stakeholders involved in the chain of the Peloponnese – Crete corridor. Its goal will be the increase of effectiveness, efficiency and continuous improvement of each unit or activity. More specifically this body will undertake:

- Coordination and support of the port authorities – infrastructures related to the new service. The co-ordination and the support concern mainly in the monitoring and evaluation of provided services, the evaluation of infrastructures, the ascertainment of problems as well as the submission of proposals for corrective interventions.
- Signing a Service Level Agreement with the transport operators and Local Authorities defining quality indicators in order to monitor the Quality of the Service Offering.
- Creation of a mechanism for the promotion of the activities that will support the operation - viability of the line.
- To ensure strong and reliable partnerships with ship lines, transport operators and tour agencies in order to achieve the biggest possible precision, the minimization of the waiting line to interchanges, the organization and promotion of the accommodation facilities, the sightseeing tours.
- Clarify the roles of local authorities and transport operators in information provision.
- Continuous monitoring of activities and submission of proposals for corrective actions in case the initial demand estimates are obsolete (i.e. lower or higher real demand than planned).
- Organizing or undertaking information campaigns in Greece and abroad in order to advertise the new services (when these are introduced from the port or ports that will provide them). This tasks aims to increase the travellers’ awareness level and also lead to the use of the services as well.

6.10.9.2.15 Cost Structure (C\$)

The suggested business model is clearly cost-value driven.

From a management accounting standpoint there are two types of costs in delivering the planned service bundle:

- Fixed Costs – they are asset acquisition and administration costs, calculated on an annual basis. They remain the same no matter how many pax there are – additional (incremental) pax add no incremental costs.
- Variable Costs – they are capacity and support provision costs, calculated on an annual basis by assuming a range of total pax – additional (incremental) pax add incremental costs, which for reasons of simplicity can be estimated using a cost scaling factor.
- Total Costs – the sum of fixed and variable costs.

There are also two ways to look at profitability – overall, and per service (or product) sale.

- Total Profit – The sum of all sales minus the total costs to make and sell the service (or product), including overhead.
- Contribution Margin – The difference between service (or product) revenue and the variable costs to make and sell the service / product.

When the total revenue from product sales exceeds the total costs to make and sell that product, the product is profitable.

From a decision-making standpoint, a price must be selected so that the contribution margin is positive. A simple and workable way to calculate the (minimum) price required for the service bundle to breakeven is by setting the contribution margin to zero.

The number of products that need to be sold for the suggested business to be profitable is the fixed costs divided by the contribution margin.

This section includes an assessment of how much does it cost to service the Patras-Kalamata-Crete users. It includes wages, maintenance costs, etc. It also factors in upstream costs such as marketing, ticketing and insurance costs plus administration / office / etc to get the right order of magnitude.

For a better overview of the costs, they were grouped by category (fixed and variable) and individual service they refer to (i.e. bus, ferry, terminal handling and recreation).

The following table lists the various costs per category and type of individual service:

	Bus (EUR/year)	Ferry (EUR/year)	Terminal Handling (EUR/year)	Recreation (EUR/visito r-day)
Total Fixed Costs	16.000	602.000	62.350	132
▪ Acquisition/ leasing/ rental (vehicles, equipment, facilities)	0	500.000	28.800	
▪ Cost of Service	15.000	102.000	33.550	
- Wages	12.000	80.000	29.550	
- Maintenance	1.000	0	1.000	
- Administration	500	2.000	2.000	
- Upstream	1.500	20.000	1.000	
▪ Accommodation, F&B				100
▪ Recreation (cultural, sports)				20
▪ Shuttle services				12
▪ Other	1.000			
Total Variable Costs	8.000	1.000.000	2.000	0
▪ Fuel / Energy	8.000	1.000.000	2.000	
▪ Tolls				
▪ Other				

Figure 6.600: Costs per category and individual service (bus, ferry, handling, recreation)

It should be noted that all the above costs were assessed assuming a seasonal service of 4 months.

In the case of the bus, it was assumed that the vehicle is available, running for another route from which it should be transferred. For the ferry a deck-engine, bareboat chartering solution was selected. The vessel should have a maximum capacity of 500 pax, 100 vehicles and cruising speed of about 26 knots. As concerns the luggage service, the costs consist mainly of the operating expenses of 2 warehouses in Patras and Kalamata, and the personnel costs. The recreational reference package includes hotel accommodation at the ancient Olympia, a guided tour at the archeological site and shuttle services (optional) for visitors without a private car.

The recreation costs represent the expenditures a visitor has to bear in order to travel and stay at the recreation facility for one day. According to TCM, these costs are a money proxy of the benefit (the value) the visitor puts on the site, for the right of using its recreation resources (hotel, museum, archeological, sports site, etc). The costs correspond to the minimum required value of a site in order to attract PREMIUM users. Should the recreation services are offered at a discount, the more PREMIUM users will be attracted.

Summing the total fixed and total variable costs results to the total cost per individual service as shown below :

Total Costs	Bus (EUR/year)	Ferry (EUR/year)	Terminal Handling (EUR/year)	Recreation (EUR/ visitor-day)
Standard	24.000	1.602.000	64.350	
Premium				132

Figure 6.601: Total costs per service variant (standard, premium)

6.10.9.3 Description of proposed service (using the concept of Agents)

6.10.9.3.1 Agents

The agents involved immediately in the new offering are:

- The 3rd Party Provider as described above as Public & Private Partnership Special Purpose Vehicle (SPV) initiated (tendered by the Regional Authority of Western Greece, Peloponnese & Ionian Islands)
- The Port Authority of Patra
- The Shuttle Service
- The Port Authority of Kalamata
- The Port Authority of Chania
- The inter-urban bus services
- The regional/local authorities (Prefectures/Municipalities of Achaia, Helia, Messenia and Crete)
- The respective Chambers of Commerce
- Local tourist operators

While in the existing situation these agents worked independently and not in immediate competition or collaboration, as described in section 7, under the service offering they will be required to develop collaborative activities.

The agents “involved” in the “so-called” current situation, i.e. the Patra-Piraeus-Crete corridor are not included in the analysis, even though they stand to lose a portion of their business as this activity was not an active goal or objective to begin with.

Their objectives and goals vis-a-vis the offering are illustrated in the following section.

6.10.9.3.2 Objectives and Goals

The proposition of the 3rd party provider has in principal been based on the fact that no one of the above agents has the described offer as core business. Hence, the offer is designed to enhance and elaborate on each agent’s business activities and strategies. Simultaneously, the service offering is not totally outside the strategies and objectives of the agents. The offer comes as an added value to their initial activities.

6.10.9.3.3 Strategies

All agents described with the exception of the Port of Patras would benefit from the increase of business activity in the proposed corridor. Simultaneously, the Port of Patra bears no negative impact. On the contrary, the Port may benefit from this improvement.

Inter-urban buses in the Patra-Kalamata Axis might consider the shuttle a competitor. However, they are focused on a different target group of potential clients and offer different types of services.

Finally, hotel owners may also develop competitive behaviour towards the offering and the 3rd party provider. Pro-active collaboration with various hotel categories may prove important both in terms of collaboration as in terms of avoiding or minimizing competition.

6.10.9.3.4 Interactions between agents

Agents	3 rd Party Provider	Port of Patra	Interurban Bus	Hotel Owners	Port of Kalamata	Port of Chania	Local Chambers of Commerce	Local Authorities	Region of (Peloponnese)
3 rd Party Provider	X	Positive	Neutral	Positive & Competitive	Positive	Positive	Positive	Positive	Assigning Authority
Port of Patra	Positive	X	Neutral	Neutral	Neutral	Neutral	Positive	Positive	In Collaboration
Interurban Bus	Neutral/Competitive	Neutral	X	Neutral	Neutral	Neutral	Neutral	Provider	In Collaboration
Hotel Owners	Positive & Competitive	Positive	Neutral	X	Positive	Neutral	Positive	Positive	In Collaboration
Port of Kalamata	Positive	Neutral	Neutral	Neutral	X	Potential for Collaboration	Positive	Positive	In Collaboration
Port in Chania	Positive	Neutral	Neutral	Neutral	Potential for Collaboration	X	Positive	Positive	In Collaboration
Local Chambers of Commerce	Positive	Positive	Positive	Positive	Positive	Positive	Positive	In Collaboration	In Collaboration
Local Authorities	Positive	Positive	Positive	Positive	Positive	Positive	Positive	Potential for competitive behaviour	Region above local authorities
Region of (Peloponnese)	Positive	Positive	Positive	Positive	Positive	Positive	Positive	Positive	X

6.10.9.4 *Functions and Indicators to show enhancement*

6.10.9.4.1 Functions of validation

The demonstration of the expected enhancement of the proposed business model is based on a comparative analysis between the current situation and the proposed service. Taking into account that the proposed service deals with an alternative route for the targeted flows, compared to the actual situation, the comparison will be based on the following data types:

- a) transport flows attraction (current demand compared to traffic forecasts for the Origin/Destination pairs targeted for passengers with touristic trip purposes) and
- b) cost and service quality performance of the current and future service supply
- c) time savings (which is the most important advantage of the proposed model).

To proceed to the proposed analysis, a Feasibility Study is developed aiming at assessing the proposed corridor and defining the pricing policies that will allow the future service viability. Therefore, the logic behind the validation process deals with a Cost Function in a wide sense. A more detailed description of the methodology used is presented in Section 8.4.3.

6.10.9.4.2 Indicators of validation

Data for the actual situation have been collected and data for the future situation are extracted from a feasibility study. The Feasibility Study uses actual transport market data as well as infrastructure and geographical data and tries to forecast the characteristics of the future situation in terms of:

- Traffic attracted in the new corridor
- Transport Cost and/or travel time for the customer
- Values of time for the various modes and time savings

6.10.9.4.3 Methods and tools

The validation of the proposed business model will be based on an integrated methodology including the following steps:

- a) A Mixed Multinomial Logit Model

The model results in Values of Time of passengers for various modes, as well as to a Market Segmentation estimating and analyzing the potential demand of the proposed service.

- b) A Feasibility Study

The Feasibility Study proceeds to the financial assessment, in order to assess the economic viability of the proposed service and its competitive advantages, compared to the current situation.

6.10.9.5 Demonstration and Evidence of Improvement

The results of the validation process are presented in separate Annex Reports and more particularly: a) the Mixed Multinomial Logit Model development and b) the application of the Feasibility Study Method and relevant results. These results reveal the enhancement and new dynamics to be generated by the proposed intermodal service.

6.10.9.6 Added value from the case study to the HERMES project

A critical specificity this of Case Study “Extension of the Adriatic- Ionian corridor from Peloponnese to Crete” is the fact that the site under study is not a single nodal location but a corridor: the corridor Patras- Pireaus- Crete. Obviously, the examined case study directly relates to the operations of “links” connecting a nodal interchange, according to WP2 classification and typology of cases. More particularly, it concerns a “low level of service of current intermodal transport service”. In addition, it corresponds to an extreme gap of the actual business case since the current situation is based on successive independent monomodal services on various legs of the corridor, neither coordinated to each other nor integrated and the proposed (future) model deals with the operational service establishment of a “missing” link.

Consequently, this Case Study offers a complete, coherent and exhaustive paradigm of up-grade of an interchange through the establishment of a new service on a missing link. The paradigm adds value to the project since the alternative route proposed is based on the principle of “integrated intermodal service”, instead of independent “mono-modal service developments where the user himself composes his chain/route.

The proposed paradigm reveals how a missing service can be integrated in a chain in order to stimulate more rational modal shifts, alleviate congested corridors and exploit more environmental friendly solutions, offering at the same time important time and cost savings.

An innovative element of this Case Study adding value to the project is the fact that the future business model proposes more than one alternative of service offering. It proposes not only purely “transport” services but also a combination of transport and touristic services in an integrated package as second alternative. This extended service business concept, applicable in the cases of touristic trip purposes, strengthens the innovative character of the Case Study.

To achieve the objectives and apply the concept, the Case Study developed a combination of inter-related methodologies (Multinomial Logit Model combined with a Feasibility Study Model).

A problem specific survey design preceded the models' development. The whole methodological framework has been successfully validated.

The proposed case study identified the conditions for the successful creation of an alternative integrated intermodal passenger service where missing links exist. It examined intermodal solutions to establish missing services and associated the transport alternative solution with a business plan for implementing the idea. The methodological structure of the Case contains innovative elements; it can be applicable in numerous cases with "missing link" problems, based on time savings advantages. The combination of transport services with services of another nature (e.g. touristic) can also be a new field of investigation, for which the methodological framework of this Case Study is appropriate, applicable and successfully tested. All these considerations create added value to HERMES project.

6.11 Port of Patras, Greece

6.11.1 Main features of the site

The Patras Port consists of a Passengers Port which handles an important part of the total passengers sea traffic between Greece and other countries and also of a Commercial Port. It has four main piers and wharfs of approximately 3.000m total length and 8.5-10.5m depth.. The Port capacity can afford mercantile ships up to 25.000 register tons and passenger ferry ships up to 16.000 register tons and up to 220 meters length.

In the port there is a Fire department station, a Passengers Terminal, Patras Port Authorities Offices, Port Police, Customs Office, Duty Free Stores. Towage is provided by 3 private boats and piloting service is also provided.

Gounaris pier is in a trapezoid form and it is situated at the south end of the port zone. The length of the south side of the deck is 235 m and it is protected by natural blocks. The top's length is 60m. The north side consists of two quays, hitch positions 1 and 2 (130 m and 120m long respectively). . Hitch position 1 sub serves tankers, mainly bulk carriers (wheat, barley) and also tankers of liquid bulk (due to the ethanol tankers that have been placed on the top of the pier). Part of the pier's surface, which circles hitch position 1 and a passenger station, has been defined as an "area of extra Schegen" and it sub serves the ships which come from non Schegen countries. In hitch position 2, one or two fire boats are anchored as well as a floatable storage facility for the ships' oil waste. North of the Gounari pier and along with the coast there is a quay 350m long and 8.5m deep (hitch positions 3 and 4). Hitch position 3 is used by small pleasure boats and by towboats and the hitch position 4 sub serves passengers/ car ferry ships. The south port basin is pruned to the north by the pier of Agiou Nikolaou and it provides a circle of maneuver with a diameter of 360 m. and 9 m. depth. The pier of Agiou Nikolaou has a rectangle form and its length is 200 m. and width 80m. It is used as a place of amusement and for walking, and also as the area where port activities are hosted. On the sides they have constructed quays which are 9m deep (hitch positions 5.6 and 7.8). These hitch positions are used by the ports towboats.

North of the pier of Agiou Nikolaou is the quay for the ocean liners with a length of 420m and 8.5m depth except a small area at the north which is 6.5m deep. Hitch positions 9 (126.50m long) and 10 (305m long) are located there. Hitch position 9 is used by small pleasure boats or by small car ferries. Hitch position 10 sub-serves cargo boats of either bulk cargo or packaged cargo due to the existence of a cargo storage boat-house No 10.



Figure 6.602: View of the North Port of Patras

Astiggos pier follows in a trapezoid form. The south side is 160m long and 8.5m deep (hitch position 11) and it sub serves ferry boats. Its head is 70m long and 9m deep (hitch position 12) and it is used by oil & debris skimmer. The north side of the pier is 200m long and 11.90 m deep (hitch position 13) and it sub serves cargo boats of either bulk cargo or packaged cargo. Astiggos pier defines the main port basin.

North of the Astiggos pier the quay of “Glyfada” is extended, which is 375m long and 10.m deep (hitch positions 14 and 15) and it sub serves ferry boats. On the inland area of the quay is the second passenger station. The north port basin is restricted by the North pier and it also has a maneuver circle of 390m diameter and 10.5m deep.

The south side of the North pier is 220m long and 11.90m deep (hitch position 16) and it sub serves cargo ships mainly transferring containers. Its head is 85m long and 11.90 m deep (hitch position 17). Finally, the north side of pier is 120m long and 5.90 m deep (hitch position 18) and it also sub serves cargo ships.

The North pier and the pier of Astiggos compose the North port basin and also the part of the port in which the basic port functions will be gathered after the transport to the New Port of Patras.

The total length of the quays of the Port of Patras is approximately 2,800m and its type is artificial blocks. The breakwater of the port is 1.600m long and is 400m away from the inshore quay almost parallel to the coast. The sea wall is constructed by banks of natural blocks. The sea port zone is 510 quarter acre in total.

- Restaurant
- Boat maintenance and repair (performed by private companies)
- Engine maintenance and repair (performed by private companies)
- Car rental Taxi
- Playground
- Newspapers
- Clothing stored
- Super-market
- Maritime Equipment Store
- WC – Bathrooms

The accommodation capability of the current Port is however limited, due to the lack of space on land in order to cope with the great traffic of trucks and passenger vehicles. There are also great difficulties in its connection to the intercity network, since the Port is tightly surrounded by the city and therefore traffic is conducted through the city network which is completely inadequate. Due to the above mentioned problems, the Patras Port Authority S.A. in cooperation with the Ministry of Environment, Physical planning and Public works, completed the research and the construction of the New Port on Dymaeon coast has already began since 1997.

The Southern Passenger Port of Patras has jagged wharfs of 992m total length. It consists of 4 dock stations and it has 15 docks, 11 of which are used for mooring by poop. In addition the Southern Port has breakwaters of 1.236m total length.

With respect to the building of the Southern Port they have a total coverage area of 6.974 m² and they include the following buildings:

- A Passenger Terminal station with a total area coverage of 3.232,1 m² which includes information kiosks, waiting areas, cafes, bars restaurant-kitchens, stores, administration offices, agencies, medicine room, WCs, areas for the cleaners, storage areas, waste depositories, staircases and elevators, a loft of 453m², room for the electromechanical equipment, access points for disabled.
- A building for the Port Administration with a total area coverage of 1.764,5 m² which includes waiting room, offices, archive room, kitchens, WCs, vestiaries, areas for the cleaners, storage areas, control room and room for electronic equipment, loft of 121,9 m², room for the electromechanical equipment, access points for disabled.
- Substation Building which includes room for electromechanical equipment, office, WC.

- A bar - resting area building with a total coverage are of 108,2 m2 which includes a bar and auxiliary areas for it, storage areas, WCs and other covered areas.
- Cistern building with an area coverage of 126,17 m2 and capacity of 300 m3.
- Fire Department Station Building with a total area coverage of 669,76 m2 which includes outdoors covered areas, reception area, offices, dormitories, seminar room, kitchens, WCs, room for the electromechanical equipment.
- Outbuilding of the Fire Department Station with a total area coverage of 338,46 m2 which includes a workshop, storage areas, WCs and a parking area.
- North Gate Building with a total area coverage of 354,52 m2 which includes waiting areas, offices, kitchen, WCs, storage areas, room for the electromechanical equipment and relevant road works.
- South Gate Building with a total area coverage of 172,5 m2 which includes waiting areas, offices, kitchen, WCs, storage areas, room for the electromechanical equipment and relevant road works.

6.11.1.1 Identification of the site

6.11.1.1.1 Transport demand/Passenger flow

The overall international flows of Passengers, Trucks and Vehicles of the port of Patras for the period 1999 – 2010 is presented in the following schemes. According to this data, almost half of the country's overall sea passengers' traffic to / from foreign destinations is carried out by the Port of Patras.

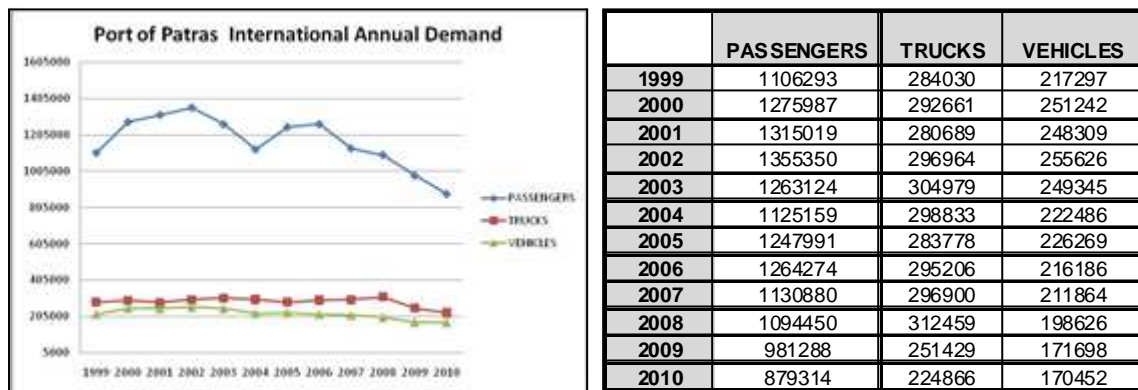
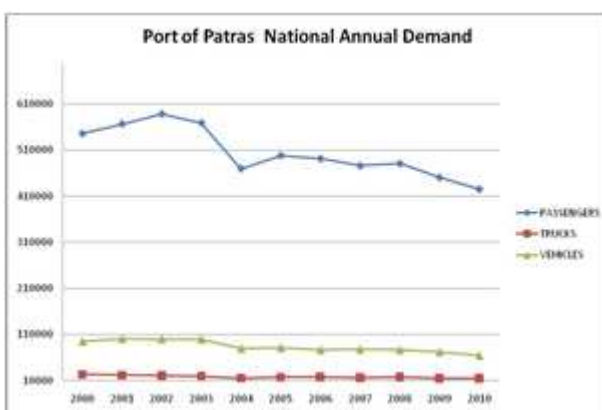


Figure 6.604 Port international annual transport demand



The national flows of the port are almost the half of the international. During 2010 almost

450 thousands passengers traveled from/to Ionian Islands using the port.

	PASSENGERS	TRUCKS	VEHICLES
2000	545758	23381	95682,00
2001	566393	21887	101260,00
2002	587877	21560	100295,00
2003	568585	20318	99907,00
2004	469783	15669	80095,00
2005	498065	17508	81890,00
2006	491490	18463	77529,00
2007	476235	16702	78442,00
2008	480687	17641	77244,00
2009	450987	15086	73017,00
2010	425503	15085	65227,00

Figure 6.605 Port national annual transport demand

There is a small decrease in the passengers and freight flow during the last eight years. The limited accommodation capability of the current Port and the construction of the Egnatia Motorway which improved the accessibility of

other competitive ports, may constitute some reasons for this decrease.

6.11.1.1.2 Transport modes and Services

The main intermodal connections of the port of Patras are:

1. Long/short distance ferry service

- There are International ferry services from/to Italy (Ancon, Bari, Brindisi, Venice) to/from Patras.
- National Port to port service from/to Patras to/from Ionian islands (Kefalonia, Ithaki, Kerkyra, Sami)

The port serves an average of 2 ships per day for national trips and 5 connections for Italy every day.

2. Long distance rail service

- Interurban rail service.

In September 2010 when the customer survey took place, there were daily eight (8) lines to/from Athens. During the last three months, the rail connection of the city of Patras with Athens has stopped due to the Greek rail organization structural and economical problems.

3. Short distance rail service

- Commuter train service

In September 2010 when the customer survey took place, there were eleven (11) commuter lines to/from Kiato connecting Patras with the interurban rail network of Athens. Today these



rail lines were replaced with bus connections operated by the rail organization in the same route.

- Interurban rail service

There is a train connection from Patras to Rio every one hour from 6.30 until 23.20.

4. Long/short distance bus service

Interurban and urban bus service. Interurban routes to/from national destinations. The terminal serves 32 lines per day to Athens, 18 to Aigio (connections with the new interurban railway to Athens), 10 to Pyrgos, 4 to Thessaloniki and Lamia and 10 lines to other destinations.

5. Long distance air service

There is the International airport of Araxos in a distance of about 40kms from Patras. There is seasonal air flights mainly charter flights from/to Germany.

6. Long/short distance road service

The port is placed in the city center connecting with the main network of the city in order to be easily accessed by taxi, private and rental cars. Patras is connecting with Athens and the rest of Greece through three main axis.

- The National Road 8 which is a single carriageway with at-grade intersections in the Attica and Peloponnese regions. It links the cities of Patras, Corinth and Athens. Until the 1960s when the National Road 8A, a toll road, replaced it as a major route, it was the only road linking Athens and Peloponnese, and Corinth with Patras. In the 1990s the section between Athens and Corinth was upgraded to motorway standards.

The highway passes at the northern part of the Saronic Gulf, through the Isthmus of Corinth and further, in the southern part of the Gulf of Corinth and ends in downtown Patras. It runs through three prefectures: Achaia, Corinth and Attica. After passing through the Isthmus of Corinth it reaches Patras after going through numerous little towns and villages as opposed to the newer GR-8A which bypasses them. It is mainly a coastal road and nowadays it is used mostly by the residents and tourists of these towns, since using this route from Athens to Patras takes approximately 4 hours, while using the newer highway takes only 2 and a half hours.

- The Greek National Road 5 which is a highway in Western Greece. It runs from 2 km south of Rio at GR-8/GR-9 (westbound), or at the beginning of the Patras By-Pass in the south up to the city centre of Ioannina. It is now connected with a new bridge, the Rio-Antirio bridge and for 5 km is a joint with GR-48 and E65. For the entire length, it is part of E55. Now the highway is divided from south of Rio to west of Antirio, and near Fragouleika. It runs on the east side of the Ambracian Gulf from Amfilochia to the Arta-Aitolocarnania boundary. Before the opening of the Arta by-

pass, the highway passed about 100 m from the historic Old Arta bridge and north of Arta. The highway has a tunnel between Arta and Ioannina.

- The Greek National Road 9 which is the second-longest national highway of Greece. It runs through the western Peloponnese, from Patras to Pylos. Its length is around 220 km (140 miles).

6.11.2 Method for data collection

6.11.2.1 Observations and collected material

The organization of the data collection for the 5th Case Study was implemented in combination and synergy with the 9th Case Study. Both the case studies were focused on the port of Patras and the combination of the long- short, national-international trips that take place there. More specifically, the 5th case study for the Port of Patras is mainly focused to provide specific solutions on how:

- i. to provide the passengers an easy transfer between the interurban and urban bus system and rail system and the port
- ii. to manage passengers and auto flows in the port
- iii. to provide services to passenger: shops, tickets office for the different operators, left-luggage room, etc.
- iv. to provide information of Ferry, bus and rail services for every possible destination
- v. to overcome all legal barriers that will arise from the additional Port services, along with the organizational/ institutional aspects

The execution of the data collection for the 5th case study of the Port of Patras followed the steps below:

1. Observation of the study team to the port in order to describe and evaluate the current operational characteristic of the port such as the transport modes, the existing information and ticketing systems, the infrastructures for the passenger's e.t.c.
2. Meetings with the authority in order to take all the appropriate documents that describe the above operational characteristics as well as the port passenger demand and the economical data.
3. Passenger survey in order to evaluate the operation of the port and give their own perception for the services that must be improved.
4. Authority survey in order to analyze the value propositions of the port the gaps and the ways to solve them through a new business model.

In order to succeed all the above steps, a specific study team was organized. The study team constituted by the Case Study Manager who contacted the port authority and after many

meetings and discussions with them has investigated the main problems of the port regarding interconnectivity issues- services, finalized the study scope and the means to succeed them, collected all the relevant to the operational characteristic data and also quantify the sample for the passenger survey.

The surveys supervisor was the main responsible for the survey execution on field. He has organized and trained interviewers and also supervised all the procedure giving solution to all the problems that rose during the survey. The surveys supervisor was also observed the port and recorded the physical characteristics and the main services and infrastructure that are offered to the passengers.

The surveys were executed by 10 interviewers who worked during a period of five days (22-27/9/2010) in the port of Patras asking the customers-passengers about the intermodal services of the port.

6.11.2.2 Customer survey

The Port is very close to the railway station, the interurban bus terminal as well as the urban bus station and the city center. This fact makes the achievement of good level of intermodality and interconnectivity of the port a quite easy target. But is this also the opinion of the passengers? The answer to these questions has been covered by the customer survey that took place in the port during September 2010.

The customer survey has been based on a well structured questionnaire, common for all the case studies. The interviewees – passengers answered to specific questions in order to evaluate the accessibility and all the services of the port related to interconnectivity. In addition ranking of the services' importance according to the passenger's opinion took place.

In order to make the common questionnaire compatible with the port of Patras case study, the case study manager during his visits to the port and during the interviews with the authority recorded all the offered services. In this way the list with the services that the passengers have to evaluate was shaped in order to include only the existing services of the port while the list with all the possible services (existing and non existing) was used in order the passengers to rank their importance.

More specifically, the collection of data regarding accessibility was succeeded through the responses to the questions of trip duration to the port and walking time at the terminal until next departure. The passengers also stated the mode that they were used in order to reach their next destination and their total walking time.

Regarding the information services there were specific questions on how the passengers would like to access this information but they had also the opportunity to evaluate and rank the existing information facilities. The passengers also rated the quality of the existing ticketing system, Banking Services, Catering Services, Newsagents, Shops, Facilities for disabled people, Seating spaces etc.

The Survey implementation followed the above steps:

STEP 1: Meeting with the Port Authority in order to organize the survey, investigate the main problems of the port regarding interconnectivity issues- services and also quantify the sample.

STEP 2: Small modification of the questionnaire in order to be in line with the specific case study needs. Translation in Greek and Italian

STEP 3: Training of the interviewers.

STEP 4: Asking for the permission of the shipping lines in order some interviews to be conducted on board.

The first step before the execution of the survey was the meeting with the Port Authority. The main scope of this meeting was to collect all the appropriate information for the port and its services and also to investigate their opinions about the interconnectivity problems and the ways to deal with them.

The port authority was very helpful and the interviews with them came up with very fruitfull results. They have also arranged all the permissions that the interviewers needed in order to access the passengers in and outboards.

In addition personal visit to the director of the interurban bus system of Patras realized in order to discuss with him the interconnectivity issues and the cooperation of the port with the bus system in the direction of time schedule cooperation, information exchange etc.

The main result of this interview was the fact that there is no cooperation between the two authorities and this is an open issue to be further discussed and analyzed.

The meeting with the port authority took place in the August 2010 in order to select their knowledge for the port services and also to cooperate in the organization of the survey. During the discussion the main problematic services of the port as well as the non existing ones were mentioned. The exact places of the survey – in the passenger terminal, ships, rest areas near the terminal- were arranged as well the permission of the shipping lines in order some interviews to be conducted on board. Finally the survey period was set for the 23-26 of September 2010 and 10 interviewers including the survey supervisor participated in this initiative.

The period was considered as typical because there was enough passenger volume during September but it was not the peak period and so there was enough space inside and outside the ships in order to talk with the passengers and implement the survey.

At the end of the survey, 560 passengers were replied to the questionnaire.

The reliability of the collected data can be assured due to the fact that all necessary quality controls have been implemented during the survey as well as all statistical principles were kept. More specifically,

- Concerning the questionnaire:

- a. Logical control of answers is possible through the crosschecking of 'linked' questions.
- b. There were observers (team leaders) responsible for the correct conduction of the interview process.

- Concerning the survey:

1. The appropriate sample was taken (560 interviewees), in order to reach at 'safe' conclusions.
2. Use of statistical software (SPSS) for the reliability of results.

6.11.2.3 Stakeholder interviews

Before and after the customer survey, meeting with the stakeholders took place in order to find out the main issues of intermodality that must be improved according to their opinion as well as to declare the main policy and infrastructure problems and the proposed improvement actions. Specific questionnaires were contacted to the port authority and the interurban bus operators while discussions with the rail terminal operators and the shipping companies were realized.

6.11.3 Stakeholders/Agents at the site

The different agents that interact in the port of Patras constitute the Port Authority, the Bus Operator (Authority), the Municipality of Patras, the shipping companies, the passengers and the taxi drivers. Hereafter the objectives and the strategies for the agents are described.

The shipping companies that are active in the port of Patras are:

- SUPERFAST (lines from/to Ancona, Bari)
- ANEK LINES (lines from/to Corfu, Igoumenitsa, Venice, Ancona)
- MINOAN LINES (lines from/to Corfu, Igoumenitsa, Venice, Ancona)

- AGOUDIMOS (lines from/to Bari, Igoumenitsa)
- STRINTZIS FERRIES (lines from/to Sami, Ithaki)
- ENDEAVOR LINES (lines from/to Sami, Brindisi, Igoumenitsa)

6.11.3.1 Objectives and Goals

The different agents involved in the operation of Patras port together with their main objectives are described herein:

- Port Authority: The objective of the port authority is to maximize its revenues through the increase of passenger demand which will result in the increase of the shipping companies' fares (as a percentage of the total ticket revenues) for using the infrastructure of the port.
- Bus Authority: The objective of the bus authority is to maximize its profits (as a private transport operator). Moreover it must be stated that since the profits of the bus operator depend on the passenger demand, the main objective of the bus operator is to increase its share between the transport modes used by the passengers.
- Municipality of Patras: The overall objective of the Municipality of Patras is to increase the social welfare of Patras' Municipality and thus take those initiatives which upgrade the quality of services to the people.
- Shipping companies: The overall objective of the shipping companies is to maximize their profits (which is translated to the increase of passenger demand).
- Passengers: The overall objective of the passengers is to minimize the time of the intermediate transfers, and also to feel comfortable and safe in the terminal's area of their trip.
- Taxi drivers: The purpose of the taxi drivers is to maximize their profits through the increase of the number of their daily trips.

6.11.3.2 Strategies

The actions that each agent can do (and has the conditions to do) to achieve its objectives are mentioned below:

- Port Authority: Since the main objective of the port authority is to maximize its revenues, the main strategy of the port focuses in the provision of attractive services

(info displays, transfer to the decks, high quality customer service) to passengers in order to increase the passenger demand. However to date, no specific plan or dedicated study was conducted, for the determination of the factors that affect passenger demand in relation to the port services.

- **Bus Authority:** The objective of the bus authority is to maximize its profits (as a private transport operator). To achieve this, the authority aims at maintaining a certain quality of service, taking into account the operating costs as well as the revenues from the specific line (bus connection to the port).
- **Municipality of Patras:** The overall objective of the Municipality of Patras is to increase the social welfare of the Patras' citizens. Concerning the passenger port services, the Municipality cooperates with the port authority and the bus operator in order to ensure a transport connection between the port and the city centre.
- **Shipping companies:** The overall objective of the shipping companies is to maximize their profits. For achieving this, (the shipping companies) are offering quality services (within the ship) to the passengers and mainly competitive prices in relation to the other transport modes (airplane).
- **Passengers:** The overall objective of the passenger is to minimize the time of the intermediate transfers, using all the facilities (signposting, internet services etc) of the port.
- **Taxi drivers:** In order to succeed their purpose (maximizing their profits), the taxi drivers determine their fee in such a way in order to be competitive in relation to the other transport modes (in terms of price and quality of service).

6.11.3.3 *Interactions between agents*

The matrix below presents the various interactions between all the involved stakeholders (agents) in the port of Patras. The different types of interactions are cooperation, collaboration, negotiation, competition and commercial.

It is noteworthy that for the current analysis of the port Patras the term 'cooperation' corresponds to an interaction type that includes certain operational (established) agreements e.g. coordination of timetables, integrated ticketing, revenue sharing etc. On the other hand, 'collaboration' between the stakeholders refers to an interaction type which is not established with strict operational criteria, however includes some basic forms of communication and coordination actions such as the connection of the port with a bus line, the provision of a

dedicated space for the taxi drivers in the port area etc. On this basis, the interaction schemes among the stakeholders for the current business model of the Patras port are described in the Table below.

Agents	Port Authority	Bus Authority	Municipality of Patras	Shipping companies	Passengers	Taxi drivers
Port Authority		<i>Collaboration</i>	<i>Collaboration</i>	<i>Commercial</i>	<i>Commercial</i>	<i>Collaboration</i>
Bus Authority	<i>Collaboration</i>		<i>Negotiation</i>	<i>Collaboration</i>	<i>Commercial</i>	<i>Competition</i>
Municipality of Patras	<i>Collaboration</i>	<i>Negotiation</i>		<i>None</i>	<i>Negotiation</i>	<i>None</i>
Shipping companies	<i>Commercial</i>	<i>Collaboration</i>	<i>None</i>		<i>Commercial</i>	<i>None</i>
Passengers	<i>Commercial</i>	<i>Commercial</i>	<i>Negotiation</i>	<i>Commercial</i>		<i>Commercial</i>
Taxi drivers	<i>Collaboration</i>	<i>Competition</i>	<i>None</i>	<i>None</i>	<i>Commercial</i>	

Figure 6.606: Interaction schemes among the stakeholders of the Patras Case Study

6.11.3.4 Graphical representation

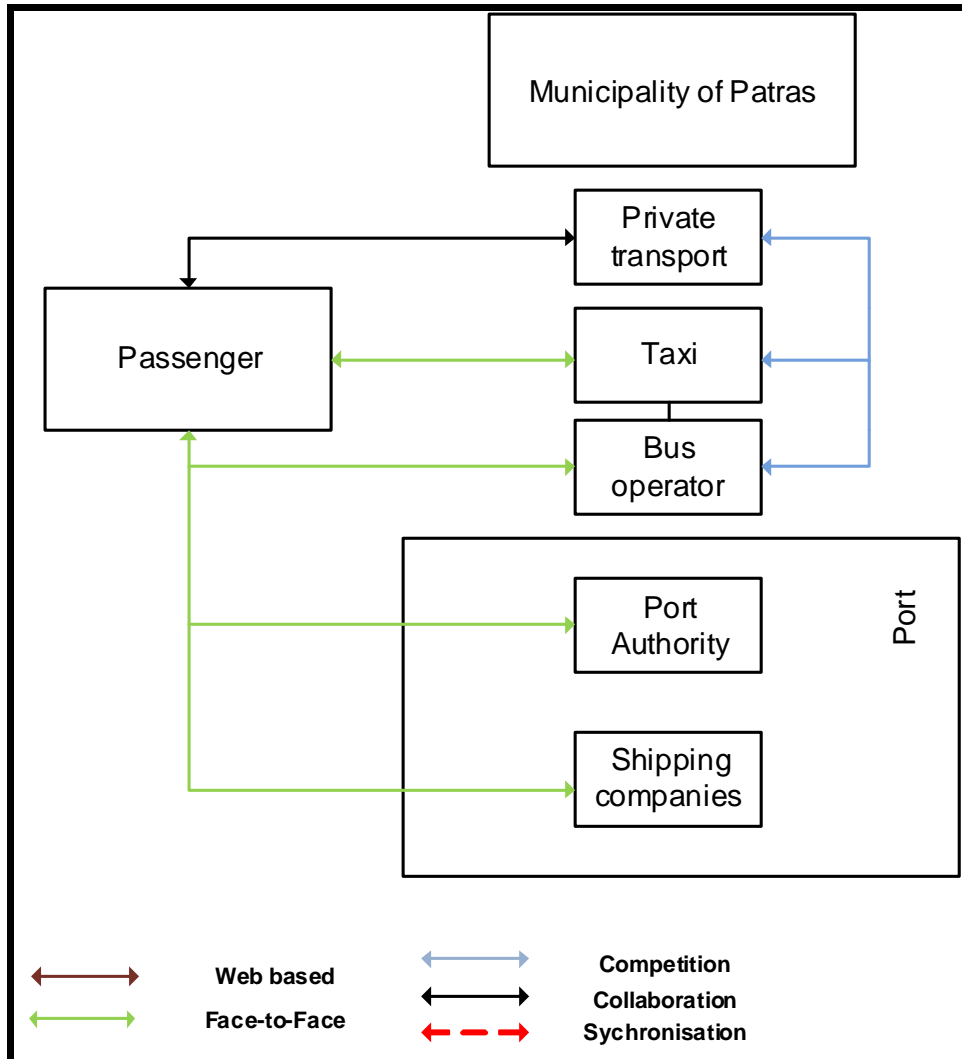


Figure 6.607 Graphical representation

6.11.4 Current short-long interconnectivity problems/opportunities

The main problems and opportunities for the port of Patras identified from the passengers and the stakeholders' survey concerned the physical dimension of interconnectivity, the logical (information display) and economical (integrating ticketing) as well as the different organization of some existing services (luggage handling).

Specifically a main (connectivity) problem of the port constitutes the long distance between the main port area (passengers' waiting area) and the platforms, for which the passengers are compelled to traverse carrying their luggage. This issue becomes even more critical as far as people with disabilities and elderly people are concerned. The port authority could overcome this interconnectivity barrier by putting small buses for transferring the passengers from the main port area to the platforms.

Another major issue the passengers' survey has emerged concerns the information displays and the signposting of the port. All passengers identified this issue as highly important and at the same time not sufficiently covered by the port. Low cost investments in signs and info displays could resolve this issue and constitute an opportunity for attracting additional passenger demand in the port.

Finally, a main (institutional) problem that was identified by the passengers' as well as the stakeholders' surveys is the lack of cooperation among the transport (and the other) stakeholders of the port. This fact affects the quality of service of the port since it leads to the lack of timetables' coordination as well as integrated ticketing. The particularity of the last interconnectivity problems is that the cooperation of all involved stakeholders is a prerequisite in order to resolve them. On the contrary the previous barriers could be arranged by the terminal operator (port authority) alone.

6.11.5 Current value proposition

It is important to state at this point that the analysis of the Port of Patras' services follows a terminal approach (site approach), meaning that the whole evaluation and the business model examination is referring to the capacities, characteristics and capabilities of the Port from the Port's Authority perspective. The overall value proposition of the Port that reaches at the final user (passenger) constitutes the 'overall economic product' of the provided transport service which is the result of various actors and stakeholders in the port area (as already mentioned, such as the shipping companies, the travel agents, the transport operators of the other modes

etc). However in the following, the description and the analysis of the business model is examined from the port's authority viewpoint, since (the port authority) is considered to be the most significant 'player' in the terminal.

Another reason for selecting the port authority as the key player for the business model consideration is that the major part of the transport services' quality of service is (or can be) affected by the port authority either in a direct or in an indirect way. More specifically the (overall) value proposition of the port can be distinguished in two parts:

1. The 'components' of the value proposition that are affected directly by the port authority (and only). These are services or attributes of the terminal for which the port authority has full jurisdiction and responsibility to intervene and arrange. These parts of the business model and the respective parts of the value proposition concern the physical dimension of the terminal (distances, transfer time etc) and the logical (informational) interconnectivity dimension, e.g. signs, info services for passengers (issues related to Business Model 2 -Transfer- of the WP2 gap analysis).
2. The 'components' of the value proposition that are affected or can be affected in an indirect way by the port authority (in cooperation with the other stakeholders). These are services or attributes of the terminal (and the broader port area in general) for which the port authority has not full jurisdiction and can intervene or influence the provided quality of service after reaching to agreements with the rest involved stakeholders. These business model and value proposition's components concern the economical (ticketing) dimension of interconnectivity, the contractual dimension and the institutional dimension (responsibilities sharing between the involved parties). These issues are mostly related to Business Model 1 -Last Mile- of the WP2 gap analysis).

For each one of the two aforementioned categories, the respective aspects of the port business model will be explored in order to define a new (proposed) business model with the necessary differentiations and additions in respect to the critical services and attributes that could raise the provided quality of service and consequently increase the passenger demand.

6.11.6 Description of current business model

According to Osterwalder (2004) there are nine building blocks Customer Segments (CS), Value Propositions (VP), Channels (CH), Customer Relationships (CR), Revenue Streams (R\$), Key Resources (KR), Key Activities (KA), Key Partnerships (KP) and Cost Structure (C\$).

6.11.6.1 Customer Segments (CS)

As it is presented in the following figure (figure 5) there is a clear seasonality of the port's demand. The period between July and October is the peak period while in April, June and May there is also high demand.

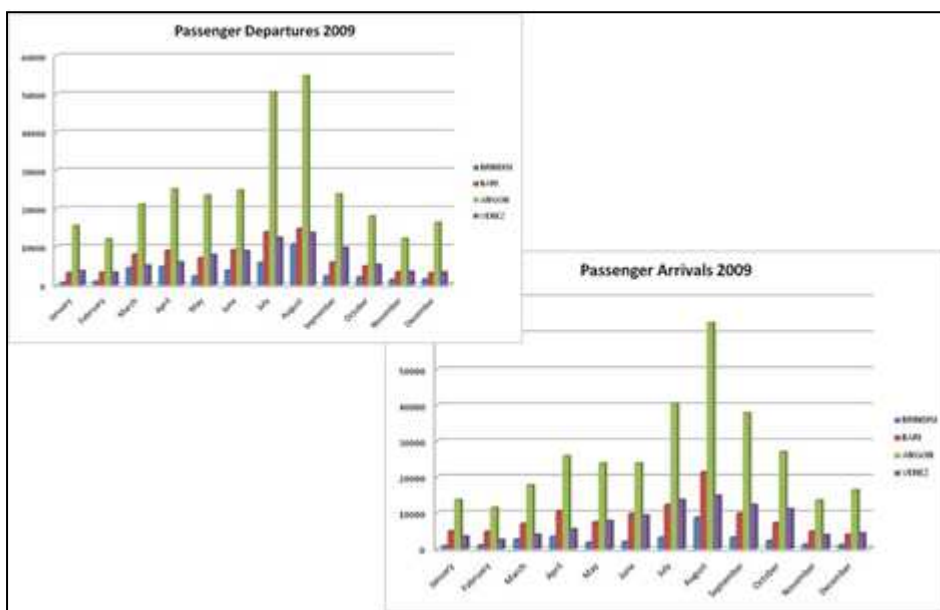


Figure 6.608: Passenger Demand per month of the port of Patras

According to the above figures it seems that the passenger ages varies mostly between 21-55 years old while there are almost equal male and female users of the port.

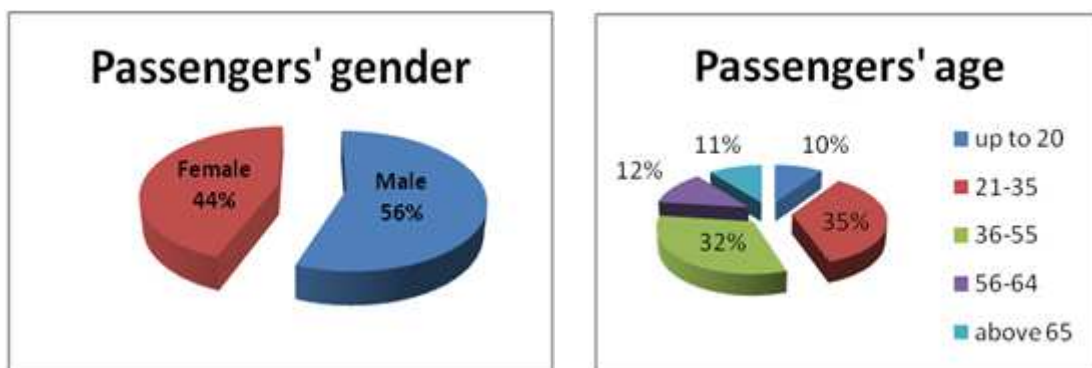


Figure 6.609: Passenger segmentation per age and gender

Regarding the passengers monthly income, it seems that the 71% earn less than 2000€ while only the 3% earn more than 5000€.

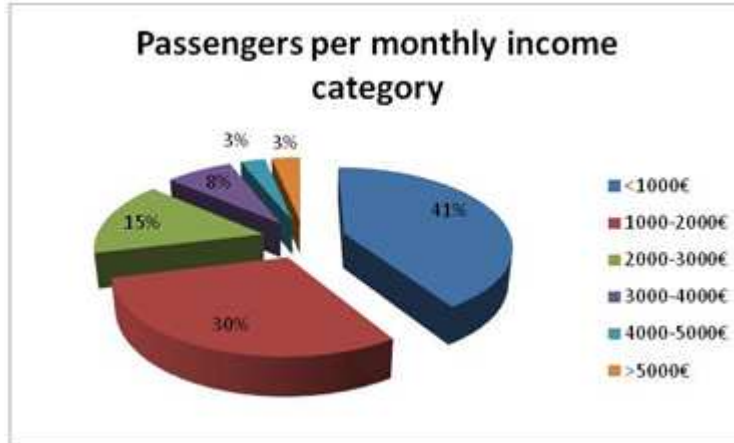


Figure 6.610 Passenger segmentation per monthly income

Kefallonia as well as Ithaki seems to be the most popular destinations of the passengers. The International trips represent also the half of the passengers' destinations.

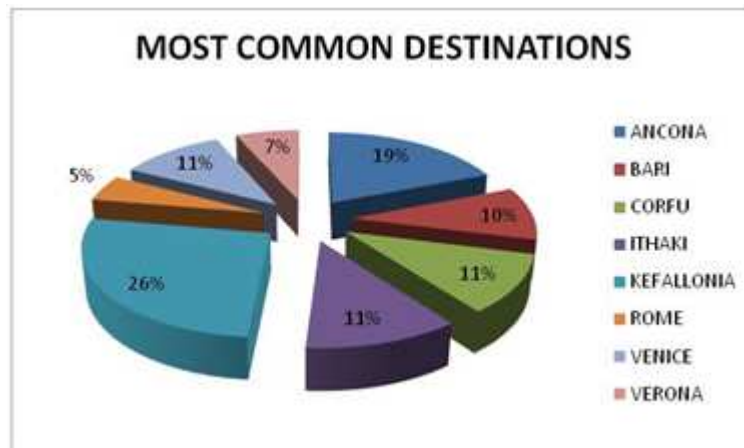


Figure 6.611:

segmentation per final destination

Passenger

Taking into account the aforementioned data, it is considered that a meaningful way for conducting the passengers' segments classification would be in relation to the national and international passenger flows of the port.

6.11.6.2 Value Proposition (VP)

The value proposition of the current business model of the port of Patras is mainly formed by the type of the provided transport services and the quality of these services.

Specifically, the main services that the Port of Patras offers are passenger and freight transportation. The port has multiple activities related to the commercial port, port, ship services and the development and exploitation.

The port of Patras is the hub for the connection of the Ionian islands and Italy with Peloponnese and mainland Greece, and commercial hub for the Adriatic-Ionian corridor, providing services to ships of all types and sizes.

The port of Patras is very near to the port of Piraeus (220 km) and can provide good ship-road-ship intermodal connection to the islands of Aegean and to Crete. In addition intermodal ship-air connection can be provided using the airport of Araxos in a distance of 40km. or ship-road-air connection using the airport of Venizelos (220km) in Athens.

Regarding the passenger transportation, the port as an intermodal transport terminal/interchange provides to the passenger all the services that they need in order to continue their trip. There are ticketing and booking services, bus connection with all the other means of transport, electronic and personal information provision services, rest areas e.t.c. All the area of the port is accessible from the people with reduced mobility. According to the results of the passengers survey most of the port's offered services are of high quality. Better quality and quantity of guiding signs inside the port as well as some more facilities for disabled people are the main improvements that the clients declared.

Conclusively it can be stated that is rather difficult to accurately define the competitive advantage of the port of Patras (in relation to the other ports) but it can be assumed that the main reasons for selecting this port over another are of two kinds:

1. First of all the geographical characteristics (location) of the port. Due to its advantageous location (southwest of Greece) , the port is capable of providing quick access and connections to people moving from southern Greece to the Ionian islands as well as to people moving to and from Italy.
2. The quality of the port's services as an interchange node in the whole intermodal passenger transport chain. From a terminal perspective, the selection between two ports that provide the same destinations can be influenced by the quality of passenger interconnectivity provided in these ports (apart from the geographical location).

The present analysis aims at identifying the gaps of the current business model of Patras port in regard to the second group of factors that influence the passenger behavior and choice in order to propose a new business model and a value proposition capable of attracting additional passenger demand in relation to the additional cost.

6.11.6.3 Channels (CH)

The main channels that the company use in order to communicate with the passenger is the internet website which provides useful information for the port and its services, monthly newsletters that inform the clients for the port operation and the events or works that might be interested in and a newspaper that the port disseminates to public.

The port advertises its services through the above means and through special editions that are disseminated to the passenger inside the ships. One recent edition is the “why patras” cruise manual which the port has published aiming at the attraction of more cruise ships.

Moreover the port offers to the shipping agents a place (inside the port) in order to sell their tickets. These are desks inside and outside the passenger terminals. There is no intervention of the port to the ticket selling or to any after-sales customer support.

Thus the port of Patras channels for reaching its customer segments can be classified into two major categories:

1. The direct channels of the port, which are the info desks (inside the port facility) as well as the website of the port (including all electronic services).
2. The indirect channels of the port that can be considered the offices and the websites of all cooperating agencies (e.g. travel agencies) and shipping companies that promote and/or use the facilities of the port for their business.

Both channels classes (direct and indirect) cover the phases of awareness, purchase and delivery (through the respective websites, info desks, offices etc). It has been already ascertained that the existing services of the port include (among others):

- Internet services (providing real time information about the itineraries as well as the modifications in time tables), as well as the possibility of itineraries searching
- Information to mobile phones (via automated SMS services). Specifically, customers can receive notification on their mobile phone regarding emergencies concerning the port that might affect scheduled international services by filling a form in the website of the port. Moreover, they can receive information on regular international services directly on their mobile, by sending a text message to a predefined number (54546).
- Informational material of the port (newsletters, flyers).

In respect to the 'channels block', the port's business model can be enhanced by the following actions:

1. The determination of the factors that can be further enhanced concerning the aforementioned channel phases (awareness raising, improvement of delivery and purchase).
2. The examination of the possibility to incorporate in the port's business model the phases of 'evaluation' and 'after sales' (in the framework of stakeholders' survey).

6.11.6.4 Customer Relationships (CR)

As the passengers are the targeted clients of the port -even though the tickets are sold by the shipping companies- it is very crucial to make the port attracted and pleasant. There are information desks inside the passenger terminal where the customers can take any tourist or transport oriented information for their trip, there is free internet access and many shops for the clients. In addition the company has recently made an arrangement with some commercial shops in the city in order to give a special discount card to the port users.

Finally, there is always available personnel in the port in order to hear the problems or complaints that the passengers have with the port services or the ticketing procedure or even the offered transportation.

In general it can be stated that in the Patras Port there is a high degree of automated services concerning the provision of information about routes as well as information about possible scheduling changes, cancellation of routes etc.

Nevertheless, the Customer Survey has pointed out some additional services which could further enhance the port's LOS. These attributes and services that must be examined as potential investment actions in relation to the customer's relationships business model block are:

- The upgrading ticketing services through an unified web platform of the port
- Info services (e.g. help desks, tourist info) of the port

6.11.6.5 Revenue Streams (R\$)

The revenue streams of the port derive from the key activities of the port authority (see key activities section below). The key activities of the port are operational, investment and financial activities. Investment and financial activities go beyond the scope of the present analysis (as explained in the 'key activities' section) while the revenues streams from the operational

activities reach the amount of almost 8.200.000 Euros for 2009. These revenue streams are allocated to the main operational port activities as following (according to the 2009 balance statement):

- Revenues from general charges for using the port facilities come up to 2.845.131 Euros.
- Revenues from renting port facilities (rooms, warehouses etc) come up to 1.338.368 Euros.
- Revenues from mooring rates come up to 1.865.877 Euros.
- Revenues from other port services (maintenance, cleaning etc) come up to 2.199.133 Euros

The aforementioned revenues are depicted in the following figure in relation to their respective percentages.

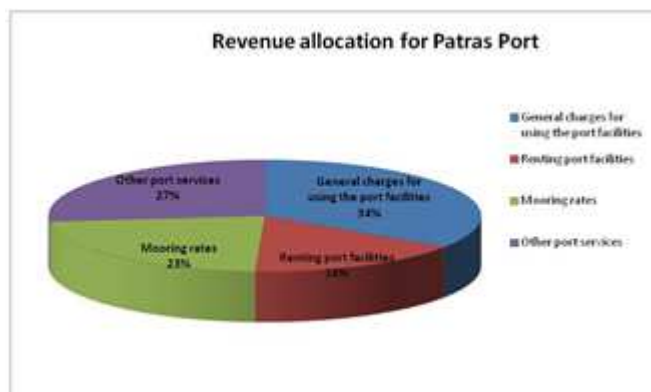


Figure 6.612: Passenger segmentation per final destination

6.11.6.6 Key Resources (KR)

The key resources of the Port of Patras can be categorized in three main groups:

1. Financial resources of the Port
2. Human resources
3. Physical resources (technical equipment)

As far as the financial resources are concerned, according to the port's balance statement of 2009 the financial disposable amount of the port authority reached the 5.686.484 Euros, at the end of 2009 (end of economic year). The financial resources of the port include among other real estate services, stocks, deposits etc.

The human resources of the port of Patras include fifty four people, which are allocated to the three divisions of the port (according to its organizational structure): the division of Economic Administration (comprised of 12 people without the administrative staff), the division of Development and Utilization (comprised of 19 without the administrative staff) and the division of the Technical Works (comprised of 14 people). The port authority also has a board of directors which is composed of ten (10) members from inside and outside the port organization. The following table shows the personnel analysis of the port in relation to their educational level.

Personnel Analysis depending on Education Level	
University Degree	9
Technological Degree	5
High School Degree	33
Elementary School Degree	6
Legal Adviser	1
Total number	54

Figure 6.613: Personnel Analysis depending on Education Level

The high skilled employees of the port (high educational level) often participate in European research projects mostly aiming at the identification of passenger demand (inrelation to new transport corridors) and the technological upgrade of the port.

Finally the physical resources of the Port include the following mechanical equipment: 3 cranes, 14 reach trucks, 8 trucks, a passenger bus, 4 cars, 9 motorcycles and some other specific equipment. In addition 3 trailing trucks owned by private companies are also available in Patras Port.

6.11.6.7 Key Activities (KA)

The port authority is conducting three different types of activities: Operational, investment and financial activities. The operational activities constitute the core business of the port, since they concern the activities related to the transport services, which are:

- General charges for using the port facilities
- Revenues from renting port facilities (rooms, warehouses etc)
- Mooring rates
- Other port services (maintenance, cleaning etc)

As far as the investment and the financial activities are concerned, it is considered that are out of the scope of the present analysis (since they are mainly related to asset and portfolio management). However it must be stated that according to the 2009 port's balance statement, the operational activities (in terms of revenues) correspond to almost 8.200.000 Euros. On the contrary, the investment and financial activities for the 2009 present an outflow that reaches the amount of 2.100.000 Euros (due to the extensive purchase of bonds and real estate properties).

6.11.6.8 Key Partnerships (KP)

The port of Patras operates as the land owner of the port facility and thus the agreements of the company (port authority) are related to the provision of permits to the shipping lines for placing their ships and transport the passengers. Among the port authority and the shipping companies there are certain financial agreements (fixed costs per ship type) for using the port facilities. Moreover there is an agreement among the port authority and an external firm for transferring the luggage of passengers from the port area to the platforms.

It is noteworthy that there is no co-operation between the port authority and the other transport stakeholders. Apart from the bilateral agreements with the shipping companies there is no agreement or cooperation (among all transport operators involved) for promoting passenger interconnectivity of the port. It has not been established any kind of connection or collaboration neither in ticketing services or itineraries nor in the level of passenger information. Even though the bus station is located near to the passenger port, each stakeholder has his own 'territory' of responsibility having no co-operation with the others. Thus, the lack of cooperation in a multimodal level constitutes a missing link and potential added value services could include integrated ticketing and information. In addition another aspect that could improve the port's business model is the possibility of conducting the luggage handling service internally without spending resources to external companies by using the port's own resources.

6.11.6.9 Cost Structure (C\$)

The Port Authority of Patras as already explained constitutes a private company that operates the terminal like a land (facility) owner. In fact the port constitutes the mediator who provides the space in order that the shipping companies can transport the passengers.

As a private company, the port authority seeks to minimize the operating costs and in the same time tries to identify the services or the attributes in the port area for maximizing the value for the users (the customers of the port).

The economic policy of the port is based both in economies of density as well as economies of scope in a sense that the main objective of the port is to attract a larger number of passengers as well as attempts to provide many different services (cruiser services, freight services etc) but also cover shopping and other recreation services, constituting a one stop shop of the port industry.

6.11.7 Current level of quality of services and customer satisfaction

6.11.7.1 Description general information about the passenger

Based on the customer questionnaire as it is presented in the following figures, the origin of the transfer in percentage of 35% emanates from Attica and Central Greece (Sterea Ellada). Attica appears to be the basic feeder of the passenger traffic. For the percentage of the passengers that declares as origin the port of Patras, 21%, there is an important uncertainty as for the validity of answer.

The most common destination, 36%, is Italy while the corridor Italy - Austria Germany assembles the 48%. It is marked that an important share of the transfers corresponds also to the Ionian Islands.

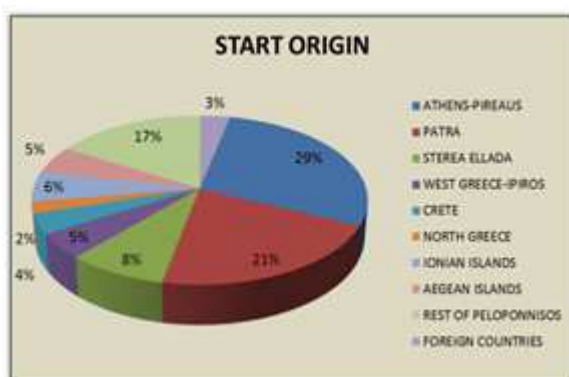


Figure 6.614: Start Origin

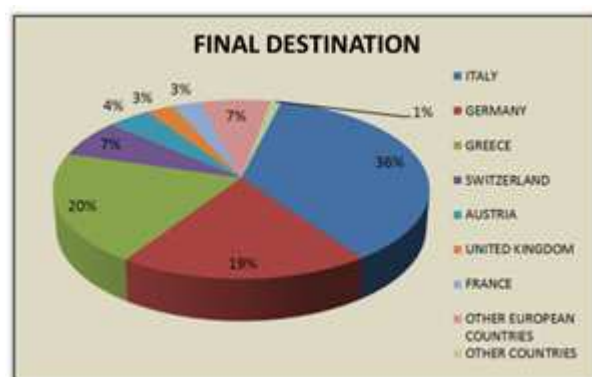


Figure 6.615: Final Destination

As it is presented below, the main reason of the trip is vacation and this is the reason why the duration of the whole trip for the most of the participants lasts up to 10 days and for more than 50% lasts up to 15 days. But we must mention also that the percentage of the people travelling for business is high 24%, and most of them have a European destination (Germany, Italy, Spain).



Figure 6.616 – Purpose of the journey

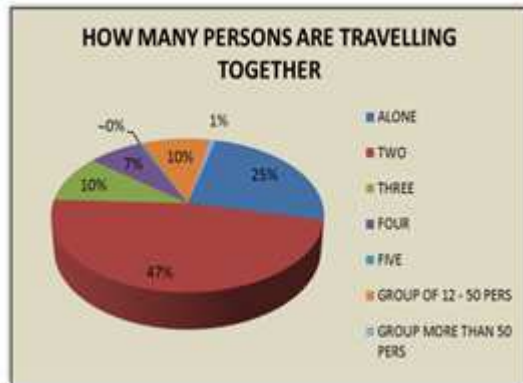


Figure 6.617– How many persons are travelling together

The percentage of the passengers that approaches the port with private transport mode exceeds the 50% (57%). Respectively the percentage of the passengers who used bus in order to reach the port is 10%. Globally, the users of public transport modes reach the 45%. This percentage is high enough and it is connected with the total level of service of the transport means, the infrastructure and total organization of the interchanges.

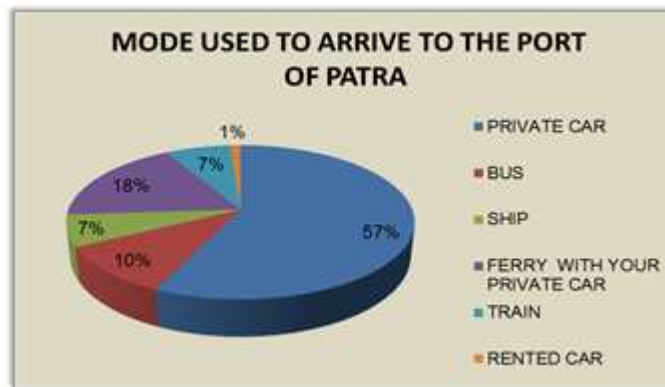


Figure 6.618– Mode used to arrive to the port of Patras

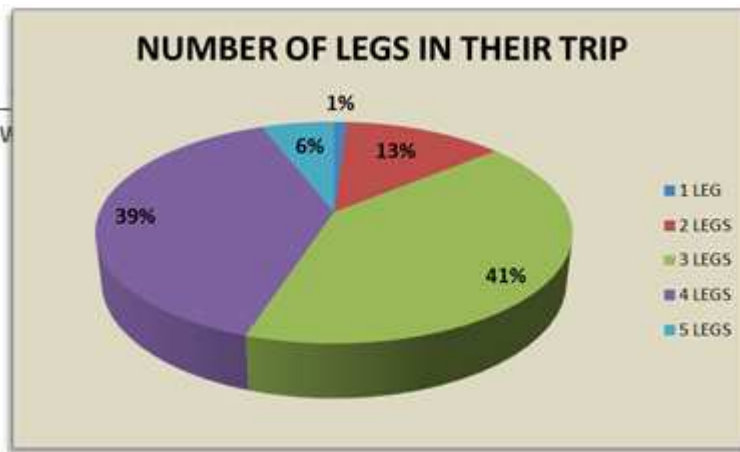


Figure 6.619- Number of legs in their trip

Finally, the customers with more that 3 legs of trip represent the 80% of the total sample while only the 1% represent the passengers with a single leg trip.

6.11.7.2 Travel demand/Passenger flow

The port of Patras according to the statistics data of 2010 serves in the peak month of August a demand of 100341 passengers and almost 18000 vehicles in its international lines. The capacity of the offered ships in the specific period seems to cover this capacity without any problems as the loading factor for the passengers seems to reach only the 32% while the same factor for the private cars is 17% and for the trucks 67%.

Travel demand/Passenger flow For the Peak Month (August)									
	Max monthly flow of passengers that can be served by the port	Monthly Passenger Demand	Passengers Flow/Demand (%)	Max monthly flow of private cars that can be served by the port	Monthly Private Cars Demand	Private Cars Flow/Demand (%)	Max monthly flow of trucks that can be served by the port	Monthly Truck Demand	Trucks Flow/Demand (%)
ANCONA	135788	59172	44%	28976	5127	18%	7244	5127	71%
BARI	26600	18784	71%	11200	2613	23%	2800	2613	93%
CORFU- VENICE	56240	13720	24%	12428	1825	15%	3107	1825	59%
BRINDIZI	31400	8665	28%	6400	1538	24%	1600	1538	96%
SUM	318236	100341	32%	66424	11103	17%	16606	11103	67%

Figure 6.620: Travel demand/Passenger flow of the peak month

From the above table it becomes clear that the offered quality regarding this factor is very high as the port can cover all the demand for international trips. This fact is very important to be known for the correct evaluation of the quality survey results.

6.11.7.3 Time

The transfer time at the terminal/interchange is in high level as we see that the 52% of the passengers participated in the survey have been transferred in the area of the port in at maximum 5 minutes. Percentage that grows to 76% for transfer in 10 min. This fact implies the satisfactory level of exploitation of the port infrastructure, the cooperating transport modes and the organization of the port operation.

The waiting time until the next departure imply undeniably that the frequencies of the itineraries are satisfactory.



Figure 6.621: Optimum Transfer time



Figure 6.622: Waiting time until the next departure

46% of the participants believe that the acceptable time to spend at the terminal/interchange is up to 30 min. Comparing the results of the figures it seems that the passengers are satisfied with their stay at the port of Patras since the waiting time until their next departure is in the acceptable limit and only a small percentage of 16% is probably disappointed.

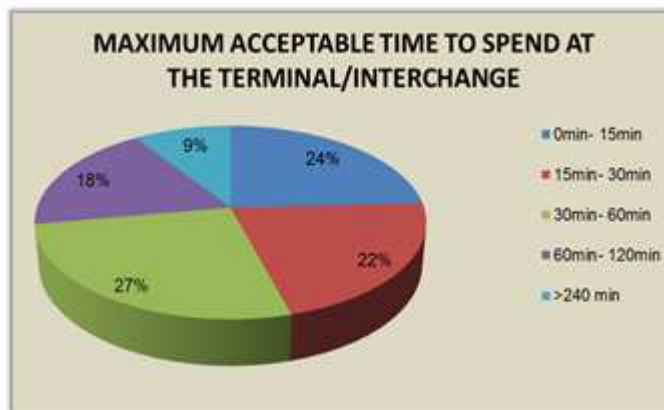


Figure 6.623: Max acceptable time to spend at the terminal

The above results is also showed in the nest figure while only the 20% of the passengers gave a negative evaluation to the waiting time factor and the timetable coordination between modes.



Figure 6.624: Evaluation of waiting time factor at the terminal

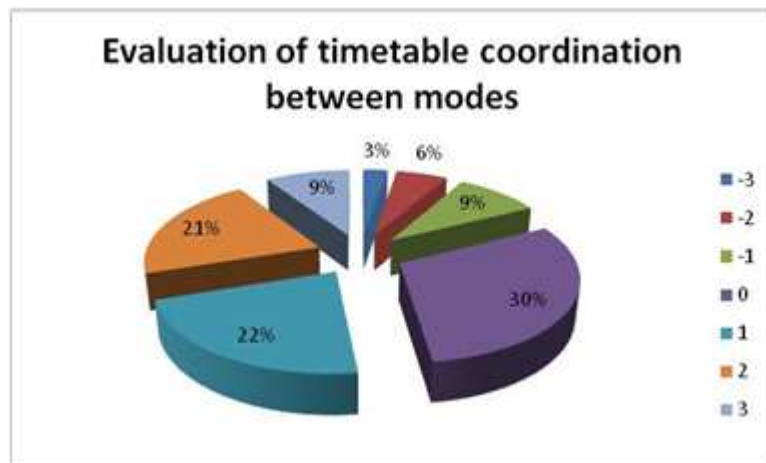


Figure 6.625: Evaluation of timetable coordination between modes

6.11.7.4 Space

The current level of space quality concerns mainly the passenger terminal and the other facilities for offered by the port to the passengers. The facilities that were evaluated during the customer survey were:

- Banking Services
- Catering Services
- Newsagents etc.
- Shops
- Facilities for disabled people
- Seating space

According to their opinion most of the facilities have a positive evaluation. Only the facilities for disable people seems to need upgrade as the 40% of the customers gave negative score. From all the other space facilities the customers were satisfied in a percentage of 60-85%.

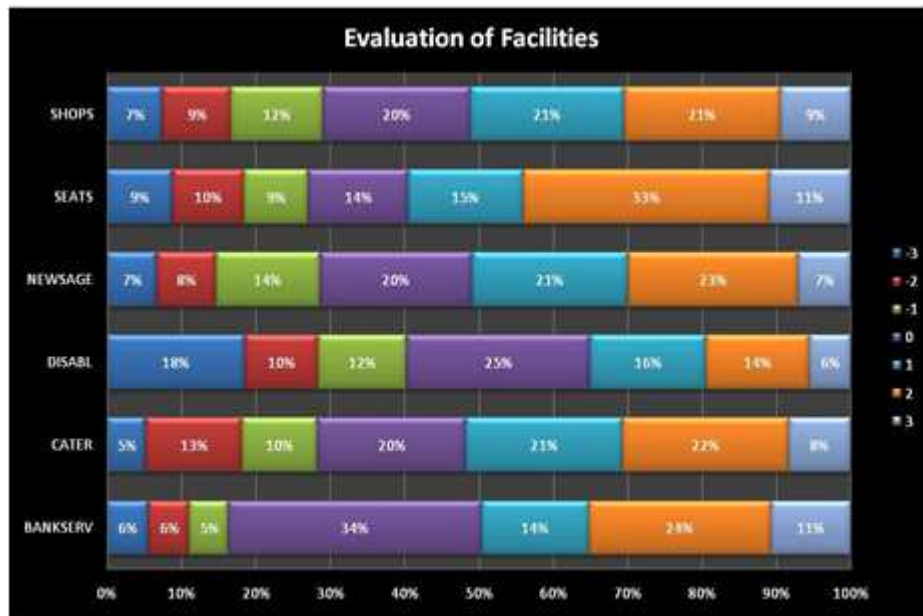


Figure 6.626: Evaluation of Space Characteristics

In addition, another factor that was evaluated by the customers was the luggage handling service of the port. The evaluation was quiet negative as the 44% rated the service from 1 to 3, the 26% from -1 to -3 and 30% gave a zero score.



Figure 6.627: Evaluation of luggage handling services

6.11.7.5 Information, Ticketing and Check-in Services

The offered quality of signposting is one of the main problems in the offered services of the port of Patras. This is the main result of the data analysis that is presented below. Almost the half of the repliers gave a negative score. Their opinion it was better for the information displays but still they were not quiet satisfied while they found the ticketing and booking system much better.

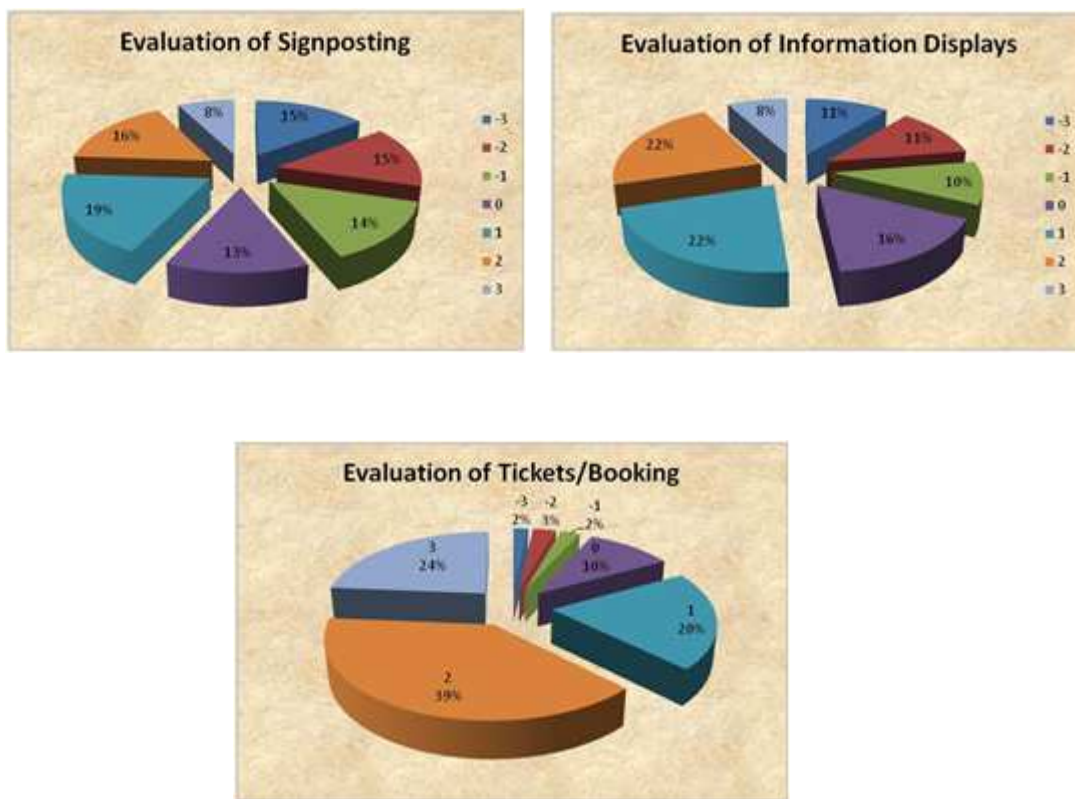


Figure 6.628: Evaluation of information and ticketing services

6.11.7.6 Added value at the site

The identification of the critical parameters is based on the rate that the passengers gave to the importance of every service and to their level of satisfaction with them. According to that, for the total of the respondents the most important factors and their satisfaction with them is presented in the following quadrant diagram.

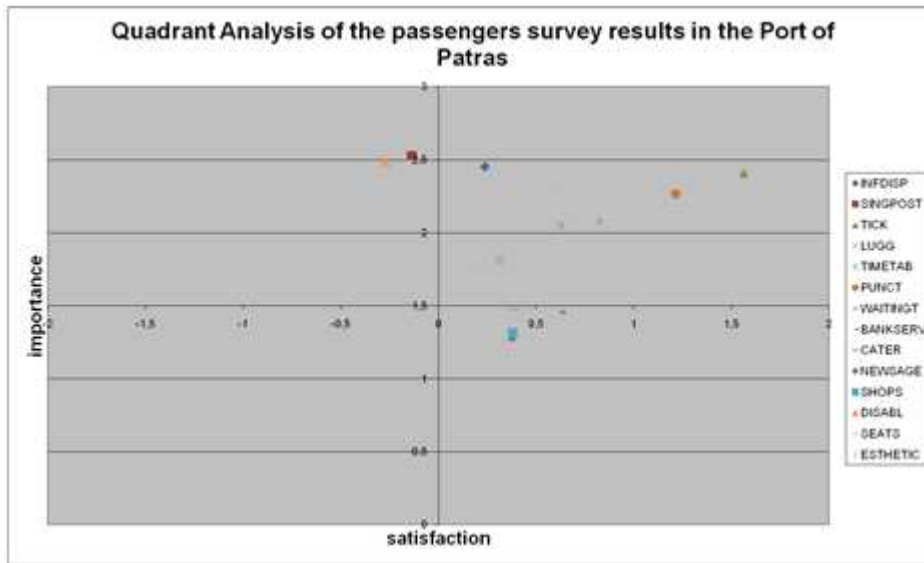


Figure 6.629: Results of the overall quadrant analysis

From the above figure it becomes clear that the most important services of the port are the Information displays, the Signposting & directions, the tickets/booking and the facilities for disabled people. For three of these factors their satisfaction is too low and special attention must be given on those issues from the administrative authority of the port. These are mainly the results of the Greek interviewees as the foreigners believe that the same parameters are very important but they are quite satisfied by them.

In the following diagrams it is explored how the market segmentation influences the evaluation of the transport system parameters. According to the mode that the passengers had used to reach the port one can see that the users of private cars are in accordance with the results that were presented before. The non car users seem to be more positive with the port services as they gave better satisfaction scores to most of them. They also agree that the Information Displays, Signposting & directions, tickets/booking and facilities for disabled people are the most important services of the port.

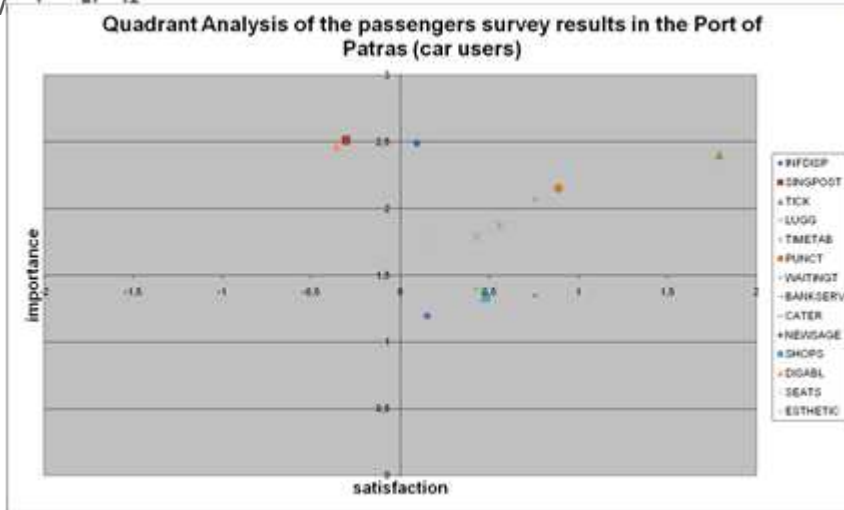


Figure 6.630: Results of the car users' quadrant analysis

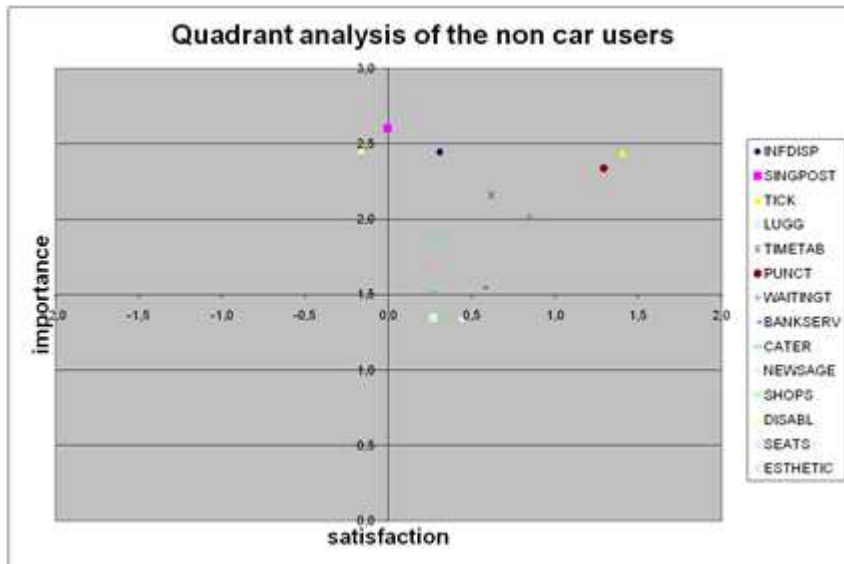


Figure 6.631: Results of the non car users' quadrant analysis

According to the passengers' nationality the results of the quadrant analysis are showing some interesting differences as it is presented below.

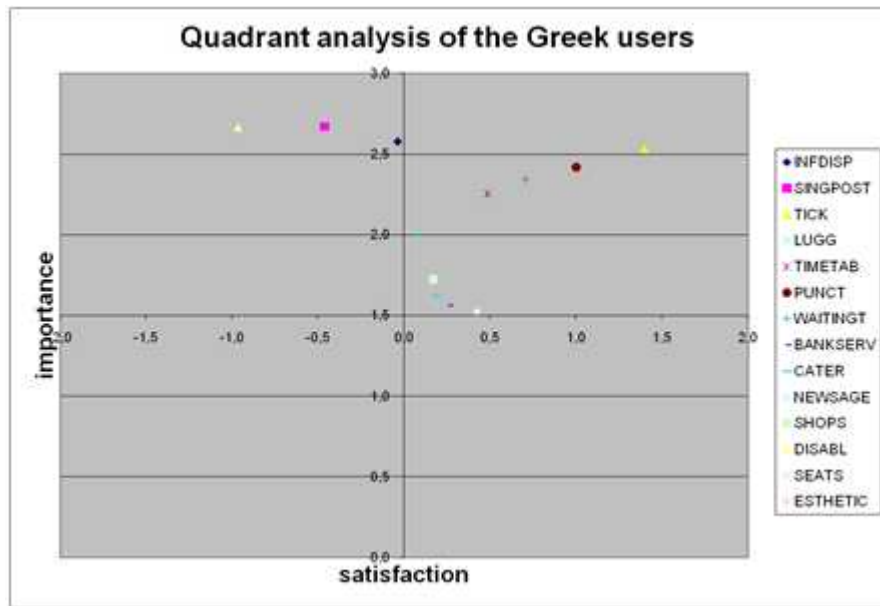


Figure 6.632: Results of the Greek users quadrant analysis

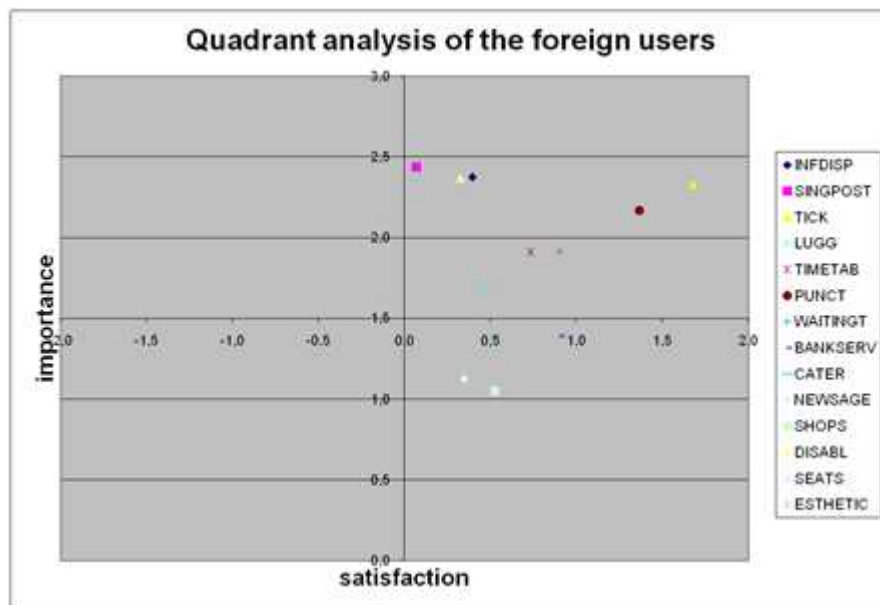


Figure 6.633: Results of the foreign users' quadrant analysis

It seems that the local people are more dissatisfied with the important services as they believe that the quality level of the Information system, the signposting & directions service the disable people facilities, the luggage handling and the esthetics of the port is too low. The foreign people have generally a better impression for the offered services of the port.

6.11.8 Analysis for improvement of interconnectivity

6.11.8.1 Comparison between customers and stakeholders

The main problems concerning the offered services of the port that the passengers were mentioned was the signing, the information displays, the facilities for the disabled people and the luggage handling. These problems are fully in line with the quality improvements that the authority intends to realize as it is presented analytically in the following sections of this report.

In addition the Port Authority as well as the Bus Authority believes that one major problem for the intermodal transportation of the area is the cooperation between the different transportation systems. The timetable cooperation was of high importance and quite low rating according to the passengers' opinion also. The very limited distances of the terminals and the placement of the old port in the center of the city resulted to the better rating of the intermodality issues. Having in mind that the new port is quite far from the terminal of the other modes and the city, it becomes absolutely necessary for the port authority to have a good and a close cooperation with the other modes.

Another issue that the port has also in mind is the quality of the rest areas and the facilities for the passengers who wait in the port. Some of the offered services such as the internet, the shops and the snack bars are trying to be improved and are going to be more advanced in the new constructed port.

6.11.8.2 Validation of findings in WP3/WP4

In the framework of WP3/WP4 of HERMES project, five clusters of barriers were identified, which are referred to as challenges for the improvement of intermodality/ interconnectivity of passenger transport. These challenges are briefly discussed below and compared with the conclusions and the results of the port of Patras' case study in order to validate the barriers and the measures identified.

First of all the WP3/WP4 deliverable underlines the challenge of improving the physical interfaces, which is referred to barriers concerning the planning and design of terminals, the capacity of the infrastructure, as well as the management of physical interfaces. This challenge includes both 'hard infrastructure measures' and 'soft measures', such as improving the lightning in stations, optimizing the visual orientation or the provision of elevators as stated in WP3/WP4. This conclusion is in accordance with the results of the passenger and stakeholder survey in the port of Patras which highlighted the signposting of the port area as the most critical requirement of the passengers.

Secondly the WP3/WP4 report recognizes the challenge of cooperation among operators, representing barriers which are related to cooperation and coordination among operators. The corresponding issues comprise integrated planning of services, coordinated schedules, integrated ticketing systems, the exchange and harmonization of information, as well as common operational standards. This issue is also underlined for the port of Patras case, since the lack of cooperation among the involved stakeholders constitute a major drawback, which results in the lack of integrated web ticketing services and in the inexistence of coordinated timetables.

Finally the challenge of coordinating public activities is raised in WP3/WP4, representing barriers which are related to public authorities and their influence on the provision and improvement of intermodal transport services. This is also implied in the case of Patras port since the cooperation among the involved transport stakeholders could be (more) easily promoted by initiatives originated by the central or local government.

6.11.8.3 Missing links and new Value Proposition

The new (proposed) value proposition of the Patras Port derives from the combination of the first two business model prototypes as defined in WP2, namely from the 'seamless transfer' (Business Model II - Transfer) and the 'transport legs integration' (Business Model I - Last mile) value proposition. The alterations of the current value proposition of the port in relation to these two new (proposed) value propositions correspond to the initial categorization of the value proposition components conducted in paragraph 'Current value proposition', which distinguished the value proposition components in relation to whether the attributes under consideration constitute exclusive responsibility of the port authority or not.

As a result it can be stated that the missing links of the port of Patras for the enhancement of the passenger interconnectivity in relation to the 'seamless transfer' value proposition are:

- The adequate signposting and info displays
- The transfer to the platforms of the passengers and the luggage

Furthermore the missing links of the port of Patras for the enhancement of the passenger interconnectivity in relation to the 'transport legs integration' value proposition are:

- Integrated ticketing via the port's webpage (one shop stop)
- Coordinated timetables of alternative modes (ship and bus)

The aforementioned missing links are examined in respect to the alterations of the new proposed business model in the following paragraph.

6.11.9 Actions for improvement of interconnectivity

6.11.9.1 Proposal

As stated in the study, the main barriers and the respective improvements of the Patras Port concern the enhancement of the passenger interconnectivity in relation to the following attributes:

- The adequate signposting and info displays
- The transfer to the platforms of the passengers and the luggage
- Integrated ticketing via the port's webpage (one shop stop)
- Coordinated timetables of alternative modes (ship and bus)

The first two measures (signposting and free transfer of passengers and luggage) are strictly related to the port authority while the last two measures (integrated ticketing and coordinated timetables) presuppose the close collaboration between all different agents involved. The first group of measures addresses the problem (barrier) of increased waiting times and low passenger comfort while the second group promotes interconnectivity as a whole, resulting in the enhancement of the quality of services.

The combination of the proposed measures tackle all the major barriers for the promotion of passenger intermodality in the port of Patras which are mainly related to the lack of sufficient info provision and lack of cooperation between the stakeholders (which both lead to increased transfer times).

In the next paragraph, the affected blocks of the Osterwalder's business Model of the port in relation to the aforementioned suggestions are described in detail.

6.11.9.2 Description of new business model

The proposed new Business Model of the port of Patras differs from the current one in the following business model components described herein.

6.11.9.2.1 Customer Segments (CS)

Proposed segmentation based on the origin and destination of passengers in relation to internal (national) flows and external (international) flows of the port. It is proposed that further

research should be focused on the identification of 'international' tourists' needs concerning passenger interconnectivity.

6.11.9.2.2 Value Proposition (VP)

The new (proposed) value proposition of the port is associated with the already identified 'Prototypes' of the HERMES Project as following:

1. Achievement of 'Seamless transfer' through:

- Adequate signposting and info displays
- Transfer to the platforms of the passengers and the luggage

This first group of measures is associated with the desired quality of service of the port authority. The present study has pointed out the main attributes of the port that customers would like to be improved. This improvement is directly connected to the increase of passenger demand (as shown in 7.4). Moreover, these specific improvements concern the terminal area and thus the only responsible for the implementation of these measures is the port authority itself.

2. Achievement of 'Integration of transport legs' through

- Integrated ticketing via the port's webpage (one shop stop)
- Coordinated timetables of alternative modes (ship and bus)

This group of measures corresponds to the proposals which presuppose the cooperation of all involved stakeholders. The first step towards the implementation of these suggestions is the close cooperation between the port authority, the shipping lines and the other transport operators. The specific proposals (integrated ticketing and coordinated timetables) have been identified after the thorough analysis of passenger demands from the passenger survey in relation to the most 'important' services-attributes that the port authority should provide.

6.11.9.2.3 Channels (CH)

An additional channel will be added for allowing passengers to purchase tickets through the webpage of the port.

6.11.9.2.4 Customer Relationships (CR)

The customer relationship will be improved due to the upgraded commercial transactions via the port's webpage.

6.11.9.2.5 Revenue Streams (R\$)

The revenue streams of the port are expected to increase in the medium to long term time horizon through the increase of passenger demand which will lead to higher revenues for the shipping companies. As the port of Patras is becoming more 'popular', the port authority would be able to raise its economic demands from the shipping companies. However this is to be expected at a later stage and no strict time horizons or amounts could be stated without further dedicated study due to the qualitative character of the improvement of port's characteristics.

6.11.9.2.6 Key Resources (KR)

N/A

6.11.9.2.7 Key Activities (KA)

The key activities of the port are not differentiated except for the addition of the integrated ticketing service which is currently offered only by the private companies and the travel agencies.

6.11.9.2.8 Key Partnerships (KP)

The port authority should approach the involved transport stakeholders as well as the Municipality of Patras in order to examine the possibility of providing integrated ticketing services through the port's website as well as coordinated timetables.

6.11.9.2.9 Cost Structure (C\$)

The interventions which influence the cost structure of the port are those of the 'Seamless transfer' value proposition and namely the addition of signposting and the transfer to the platforms of the passengers and the luggage. The costs for the signposting are estimated around 30-35.000 euros for the vertical signposting and 45.000 Euros for the horizontal signposting. Conclusively an amount of 80.000 Euros could fully equip the port with the adequate signposting which remains the most important request of the passengers.

6.11.9.3 *Description of proposed service (using the concept of Agents)*

6.11.9.3.1 Agents

6.11.9.3.2 Objectives and Goals

The overall objectives as well as the primary goals of the agents in the new business model remain the same. Since most of the agents involved concern private entities, the maximization of their profits should be considered as their overall objective. However, another important dimension is that all involved agents realize their service as part of a system (intermodal way of thinking). Once they realize that, an additional objective would be the promotion of the system as a whole, by the enhancement of the passenger intermodality in the port. This can be achieved only through the development of a new business model with different types of cooperation schemes between the agents (as already described), which would consequently alter (to a certain degree) the objectives and the goals of all involved parties. The common objective should be the settlement of all rising cooperation and collaboration issues for achieving a well organized intermodal environment up to the customers' needs.

6.11.9.3.3 Strategies

Patras Port authority: The strategy of the Patras port authority for achieving the promotion of passenger intermodality should be twofold: On the one hand it is related to actions and measures that the port authority is the main responsible for their implementation and on the other hand in measures that presuppose the collaboration of all agents. As a result, the overall strategy of the port should be the better operation and management of its own resources (addressing the passengers' needs) as well as the set up of a cooperation network among all agents for the implementation of new technological services. Specifically, the better use of resources for the Port Authority concerns the investments in adequate signposting and info displays as well as the transfer to the platforms of the passengers and the luggage (related to the 'Seamless Transfer' prototype). On the other hand the enhanced cooperation with the other stakeholders will lead to the integrated ticketing via the port's webpage (one shop stop) and the coordination of timetables among the different modes.

Bus operator: To achieve its primary objective (maximizing the profits) the bus operator should also consider to increase its quality of services and thus it can be stated that as a secondary objective the operator should strive for minimizing the transfer times from the ship to the bus and vice versa, in order to increase its share between the transport modes used by the passengers. The reduction of transfer times can mainly be achieved with the coordination of timetables as well as the integrated ticketing with the shipping agencies. This is the main reason

that an upgraded cooperation framework is proposed among the bus operator, the shipping agencies and the port authority.

Municipality of Patras: Concerning the passenger port services, the Municipality can cooperate with the port authority and together with the rest stakeholders (bus operator, taxi drivers) seek the investments that can best promote passenger interconnectivity and the cooperation of all parties (maybe through institutional/legal initiatives).

Shipping companies: The overall objective of the shipping companies could be also achieved through the offer of high quality services to the passengers in relation to the intermodal character of the port. Integrated ticketing as well as decrease of transfer times may well increase passenger demand of the respective shipping companies (as indicated in section 7.4). As already discussed, this could be achieved by the improvement of cooperation between the transport operators as well as the port authority.

Taxi drivers: In order to achieve their objective (increase of daily trips), it is in the best interest that the total passenger demand of the port is increased. For this reason taxi drivers should also try to cooperate and identify their role in the new intermodal environment of the port, in collaboration with the rest agents.

Passengers: Even though the passengers' objectives remain the same (minimization of transfer times), in the new business model of the port all passengers would have the opportunity to use innovative technology services (integrated ticketing) as well as enhanced info provision aiming at the further minimization of their transfer time.

6.11.9.3.4 Interactions between agents

Potential future interactions between the agents in the port of Patras concern cooperation and collaboration issues for upgrading the intermodal character of the terminal. As discussed earlier, this is for the best interest of all involved agents. Specifically, potential areas of cooperation is the integrated ticketing, for which the involvement and the collaboration between the Municipality of Patras, the port authority, the shipping agencies as well as the bus operators and the taxi drivers is necessary in order to define a viable scheme for fares' setting and revenues sharing. Moreover, an additional opportunity for interaction between the agents is the coordination of the timetables of the different modes. Again in this case, the collaboration between the port authority, the shipping companies and the bus operator is required, in order to determine in detail the intermediary transfer times and modify their timetables accordingly. The matrix below presents the new (proposed) interactions between the agents (the modifications are highlighted with bold letters).

Agents	Port Authority	Bus Authority	Municipality of Patras	Shipping companies	Passengers	Taxi drivers
Port Authority		Cooperation	Collaboration	Cooperation	Commercial	Collaboration
Bus Authority	Cooperation		Collaboration	Cooperation	Commercial	Competition
Municipality of Patras	Collaboration	Collaboration		Collaboration	Negotiation	Collaboration
Shipping companies	Cooperation	Cooperation	Collaboration		Commercial	None
Passengers	Commercial	Commercial	Negotiation	Commercial		Commercial
Taxi drivers	Collaboration	Competition	Collaboration	None	Commercial	

Figure 6.634: Proposed interaction schemes among the stakeholders of the Patras Case Study

6.11.9.3.5 Graphical representation

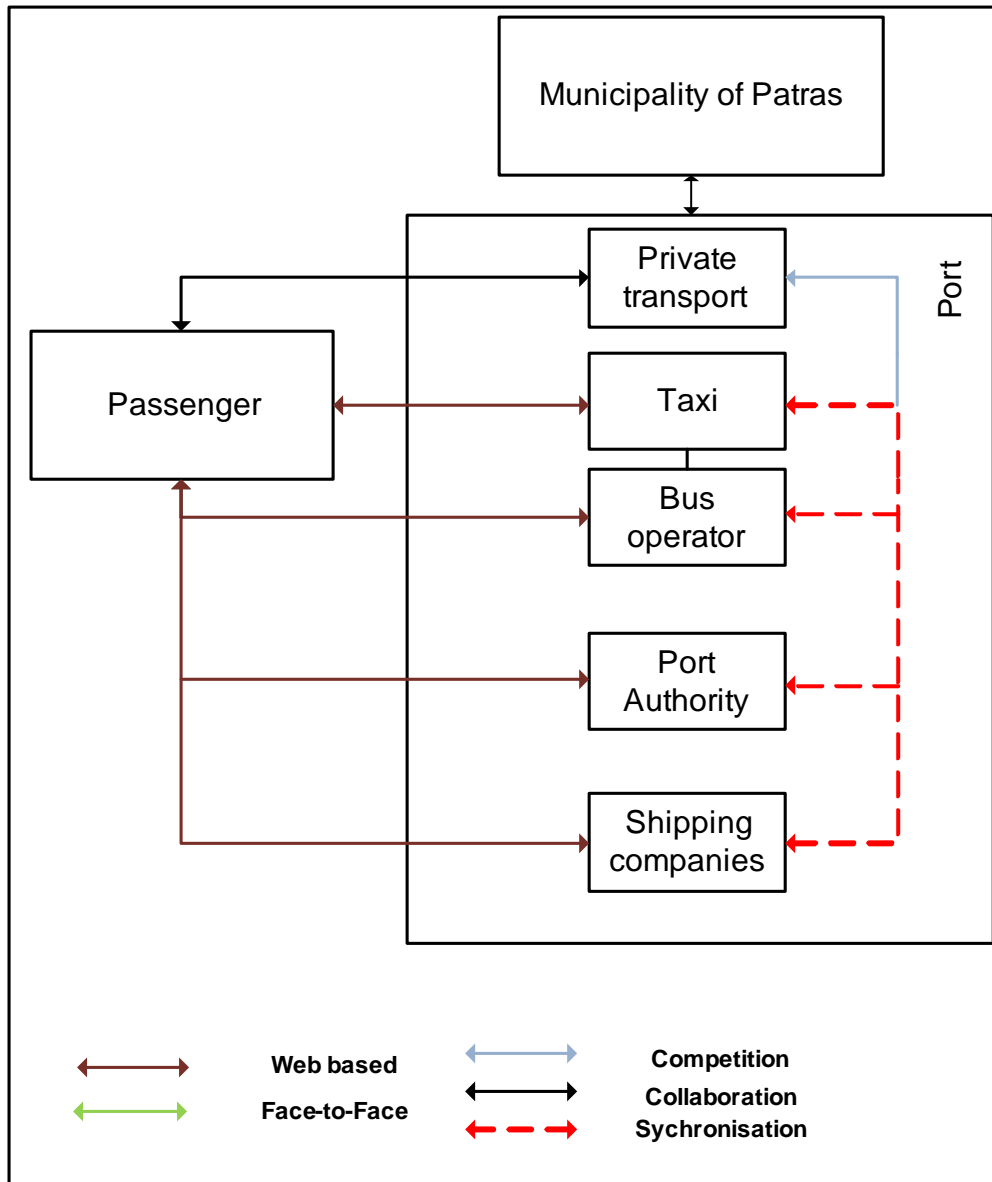


Figure 6.635 Graphical representation

6.11.9.4 *Functions and Indicators to show enhancement*

6.11.9.5 *Functions of validation*

The main elements of change (proposals), will be realized through specific functions and will affect the agents interactions as described below.

Proposed BM

Proposal(s)	Function	Agents	Interactions
Improvement of terminals' information and cooperation between the modes	Coordinated timetables of alternative modes (ship, bus, KTEL etc.)	Port Authority Bus Authority Shipping companies Taxi drivers	Cooperation/Collaboration
Maintain/Increase information quality and standard in station	Transfer to the platforms of the passengers and the luggage	Port Authority Municipality of Patras Shipping companies	Cooperation/Collaboration
Smoother integration of the transport services	Integrated ticketing via the port's webpage (one shop stop)	Port Authority Bus Authority Municipality of Patras Shipping companies Passengers	Cooperation/Collaboration
Improvement of terminals' information to customer	Adequate signposting and info displays	Port Authority Municipality of Patras	Cooperation/Collaboration

Figure 6.636: Function of validation for the Patras Case Study

6.11.9.6 Indicators of validation

The main indicators that are proposed in order to evidence the benefits generated by the above proposed action are presented in the following table.

Proposed Improvements	Indicators to show enhancement
Coordinated timetables of alternative modes (ship, bus, KTEL	<ul style="list-style-type: none"> • Transfer Time reduction • Waiting time reduction • CSI upgrade

etc.)	
Transfer to the platforms of the passengers and the luggage	<ul style="list-style-type: none"> • CSI upgrade
Integrated ticketing via the port's webpage (one shop stop)	<ul style="list-style-type: none"> • Transfer Time reduction • Waiting time reduction
Adequate signposting and info displays	<ul style="list-style-type: none"> • CSI upgrade • Transfer Time

Figure 6.637: Indicators of validation for the Patras Case Study

The coordination of the timetables between the alternative modes is expected to bring reduction to the transfer time mainly by minimizing the respective waiting time.

The easy transfer to the platforms of the passengers and the luggage is expected to upgrade CSI.

The integrated ticketing via the port's webpage (one shop stop) will minimize the transfer time as the passenger won't spend time to buy tickets for his next destination and it will also ensure the minimization of his waiting time. .

Finally, the adequate signposting and info displays will result to a reduction of transfer time and a Customer Satisfaction Index increase.

6.11.9.6.1 Methods and tools

The benefits of the proposed measures that were presented above, were calculated by using the results of the questionnaire survey analysis and the observations that were realized in order to estimate the time that a passenger must spend in order to be transferred from the port to specific interurban bus lines including the waiting time, the time for buying the ticket and the time to find his way for the next mode terminal.

Regarding the analysis of the passenger survey results the main findings that were used were:

1. The 14 quality measures that were ranked by the passengers can be grouped in four independent factors that are time (including ticketing/booking, timetable coordination, punctuality of modes and waiting time), information (including information displays and

signposting), comfort (including facilities for disabled, esthetics and seats) and facilities (including bank services, catering, newsagents and shops)

- The Customer Satisfaction Index for the passengers of the port of Patras can be calculated by using a linear model which correlates the CSI with the four independent factors. This model is presented below:

$$CSI = 0,262*TIME+0,386*FACILITIES+0,361*COMFORT+0,276*INFORMATION$$

- The proposed improvement are influence the factors with low ranking of satisfaction. According to the passengers' ratings, the satisfaction of the offered information quality is 1,5 so it can be improved another 1,5 grades in order to reach the excellent performance. The corresponding proposed upgrading for the other important quality measures are 2,5 for the signposting, 1.5 for the luggage handling and 1,0 for the punctuality of the alternative modes.
- Using the CSI model and the above mentioned quality improvements, the CSI upgrade was recalculated.
- For estimating the transfer time reduction due to the ticketing integration, specific observations took place calculating the mean time that a passenger spends in order to be transferred from the port to the interurban bus station and travel from Patra to Athens and other popular destinations. Separate observations were realized in order to split the calculated transfer time to waiting time and booking time.
- For estimating the transfer time reduction due to the coordination of timetables, all the relative collected data was analyzed, calculating the time between the arrival and departure of the alternative modes for specific o-d pairs.

6.11.9.7 Demonstration and Evidence of Improvement

Following the upper mentioned methodology the estimation of the indicators' values took place as it is presented in the following table.

Proposed Improvements	Indicators to show enhancement	Evidence of Improvement
Coordinated timetables of alternative modes (ship, bus, KTEL etc.)	<ul style="list-style-type: none"> • Transfer Time reduction • Waiting time reduction 	<ul style="list-style-type: none"> • Calculated to 2 hours • Calculated to 2 hours

	<ul style="list-style-type: none"> • CSI upgrade 	<ul style="list-style-type: none"> • Calculated to 20%
Transfer to the platforms of the passengers and the luggage	<ul style="list-style-type: none"> • CSI upgrade 	<ul style="list-style-type: none"> • Calculated to 45%
Integrated ticketing via the port's webpage (one shop stop)	<ul style="list-style-type: none"> • Transfer Time reduction • Waiting time reduction 	<ul style="list-style-type: none"> • Calculated to more than 1 hour • Calculated to more than 1 hour
Adequate signposting and info displays	<ul style="list-style-type: none"> • CSI upgrade • Transfer Time reduction 	<ul style="list-style-type: none"> • Calculated to 30% • Calculated to more than 20 minutes

Figure 6.638: Evidence of improvement for the Patras Case Study

The comparison between the existing timetables of the shipping lines arrival and the interurban bus departures resulted to 1 or 2 hours reduction of the existing transfer times for a passenger who wants to make an intermodal trip from Italy to Athens or other Greek destinations via the port of Patras. The coordination of the timetables can bring reduction to the transfer time up to 2 hours mainly by minimizing the respective waiting time. The Customer Satisfaction will also be 45% improved by this time factor upgrade.

The easy transfer to the platforms of the passengers and the luggage is going to upgrade the comfort factor and this fact will result to a Customer Satisfaction Index increase up to 45%.

The time that a passenger spends in order to find the interurban bus station, ask for the next departure and buy the respective ticket was calculated to 0,5-1 hour. In many cases this time resulted to a great increasing of the waiting time as there is overcapacity to the next bus departure and the passengers have to wait for one or two hours more. The integrated ticketing via the port's webpage (one shop stop) will minimize this transfer time up to 2 hours and will also ensure the minimization of their waiting time up to 1,5 hours.

Finally, the adequate signposting and info displays will result to at least 20 minutes transfer time reduction as there will be easier and less time-consuming access to the next terminal. In addition the Customer Satisfaction Index will be increased up to 30%.

6.11.9.8 Added value from the case study to the HERMES project

The objective of HERMES is the development and analysis of new mobility schemes and related organizational patterns at the interface and interconnection between long distance transport networks and local/regional transport networks of all modes.

The aim of HERMES is to develop prototypes (i.e. examples) of suitable business models for intermodal or interconnecting services that will contribute to build sustainable mobility solutions.

The impact of HERMES is very high on achieving fluid mobility chains with a clear contribution to the quality perception of passengers. Moreover, HERMES will support the sustainable development, by promoting the fluidity and quality of passenger mobility chains.

Interconnectivity and transfer from one service to another within the same mode or between modes was accessed considering all the relevant domains, such as:

- Physical (“time and space as well as interfaces”) interconnectivity;
- Logical (“Information”) Interconnectivity;
- Economical (“ticketing”) Interconnectivity;
- Contractual Interconnectivity (“company agreements”);

The case study of the Port of Patras examined a specific node of the chain between Italy and Greece aiming –in accordance to the upper mentioned scope of the project- to propose a suitable business models that will strength the role of the port as an intermodal terminal. In order to succeed this, the case study examined all the different measures of interconnectivity (logical, physical, economical and contractual) and proposed specific interventions to them. These interventions were resulted from the passenger and stakeholder opinions about the important services that must be offered in an interchange in combination with the existing offered quality of these services in the specific terminal.

The above interventions affected some of the blocks in the existing business plan creating also new interactions between the involved stakeholders. At the end of this procedure a new business model was created in order to cover the demand of the passengers and to promote the intermodal character of the terminal. This model can be used as a “prototype” to all the other similar terminals-ports.